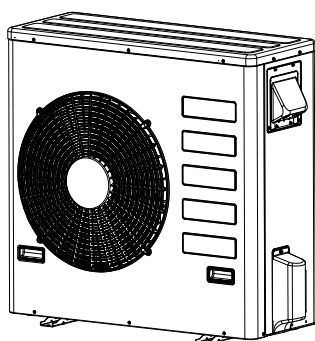
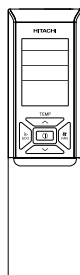

SERVICE MANUAL TECHNICAL INFORMATION

FOR SERVICE PERSONNEL ONLY
REFER TO THE FOUNDATION MANUAL

 RAS-PH18PHLAE
RAS-PH24PHLAE

 RAC-PH18WHLAE
RAC-PH24WHLAE

CONTENTS

SPECIFICATIONS-----	5
HOW TO USE -----	8
CONSTRUCTION AND DIMENSIONAL DIAGRAM-----	51
MAIN PARTS COMPONENT -----	53
WIRING DIAGRAM -----	55
CIRCUIT DIAGRAM -----	56
PRINTED WIRING BOARD LOCATION DIAGRAM -----	60
BLOCK DIAGRAM -----	65
BASIC MODE -----	66
REFRIGERATING CYCLE DIAGRAM-----	79
DESCRIPTION OF MAIN CIRCUIT OPERATION-----	82
SERVICE CALL Q & A-----	103
PROCEDURE FOR DISASSEMBLE AND REASSEMBLE ---	107
TROUBLE SHOOTING -----	117
PARTS LIST AND DIAGRAM-----	144

SPECIFICATIONS

TYPE			WALL TYPE				
			INDOOR UNIT		OUTDOOR UNIT		
MODEL			RAS-PH18PHLAE	RAC-PH18WHLAE	RAS-PH24PHLAE	RAC-PH24WHLAE	
POWER SOURCE			1 PHASE 60Hz 208-230V				
COOLING	TOTAL INPUT	(W)	1325		1650		
	TOTAL AMPERES	(A)	5.80		7.20		
	CAPACITY	(KW)	5.3		6.5		
		(B.T.U./h)	18000 (6000-22000)		22000 (7000-27000)		
HEATING	TOTAL INPUT	(W)	1500		1825		
	TOTAL AMPERES	(A)	6.60		8.00		
	CAPACITY	(KW)	6.3		7.3		
		(B.T.U./h)	21600 (6700-28000)		25000 (7100-31000)		
DIMENSIONS inch (mm)	W		43.30	37.40	43.30	37.40	
			(1100)	(950)	(1100)	(950)	
	H		11.81	37.20	11.81	37.20	
			(300)	(945)	(300)	(945)	
	D		10.23	14.57	10.23	14.57	
			(260)	(370)	(260)	(370)	
NET WEIHT			lbs (Kg)	33.1 (15)	175.3 (79.5)	33.1 (15)	175.3 (79.5)

SPECIFICATIONS AND PARTS ARE SUBJECT TO CHANGE FOR IMPROVEMENT

ROOM AIR CONDITIONER

INDOOR UNIT + OUTDOOR UNIT
SEPTEMBER 2021

SAFETY DURING REPAIR WORK

1. In order to disassemble and repair the unit in question, be sure to disconnect the power cord plug from the power outlet before starting the work.

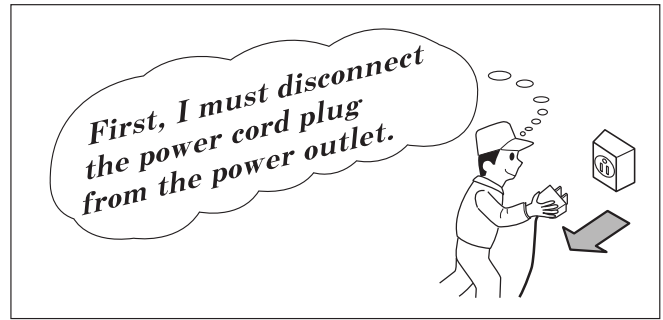

2. If it is necessary to replace any parts, they should be replaced with respective genuine parts for the unit, and the replacement must be effected in correct manner according to the instructions in the Service Manual of the unit.

If the contacts of electrical parts are defective, replace the electrical parts without trying to repair them.



3. After completion of repairs, the initial state should be restored.
4. Lead wires should be connected and laid as in the initial state.
5. Modification of the unit by the user himself should absolutely be prohibited.
6. Tools and measuring instruments for use in repairs or inspection should be accurately calibrated in advance.
7. In installing the unit having been repaired, be careful to prevent the occurrence of any accident such as electrical shock, leak of current, or bodily injury due to the drop of any part.
8. To check the insulation of the unit, measure the insulation resistance between the power cord plug and grounding terminal of the unit. The insulation resistance should be $1M\Omega$ or more as measured by a 500V DC megger.
9. The initial location of installation such as window, floor or the other should be checked for being and safe enough to support the repaired unit again. If it is found not so strong and safe, the unit should be installed at the initial location after reinforced or at a new location.
10. Any inflammable object must not be placed about the location of installation.
11. Check the grounding to see whether it is proper or not, and if it is found improper, connect the grounding terminal to the earth.

12. If refrigerant gas leaks during repair work, please ensure there is enough ventilation, leaked refrigerant that accumulates in stagnation, rarely causes any ignition when in contact with flame (stove, heater). However it will generate toxic fumes.

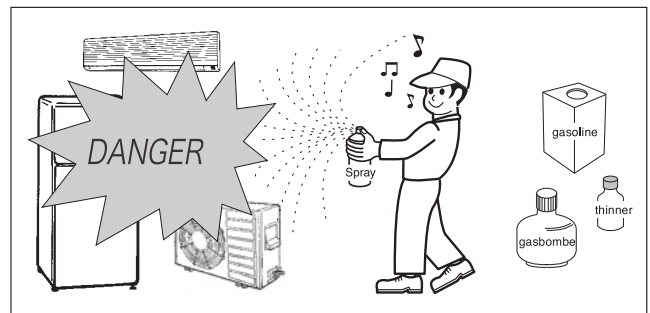

13. If refrigerant gas leaks, be sure to repair the leak(s) securely before recharge the unit. Refrigerant (R410A) is harmless. However when comes in contact with fire will generate toxic gas.

WORKING STANDARDS FOR PREVENTING BREAKAGE OF SEMICONDUCTORS

1. Scope

The standards provide for items to be generally observed in carrying and handling semiconductors in relative manufacturers during maintenance and handling thereof. (They apply the same to handling of abnormal goods such as rejected goods being returned).

2. Object parts

- (1) Micro computer
- (2) Integrated circuits (I.C.)
- (3) Field-effective transistor (F.E.T.)
- (4) P.C. boards or the like to which the parts mentioned in (1) and (2) of this paragraph are equipped.

3. Items to be observed in handling

- (1) Use a conductive container for carrying and storing of parts. (Even rejected goods should be handled in the same way).

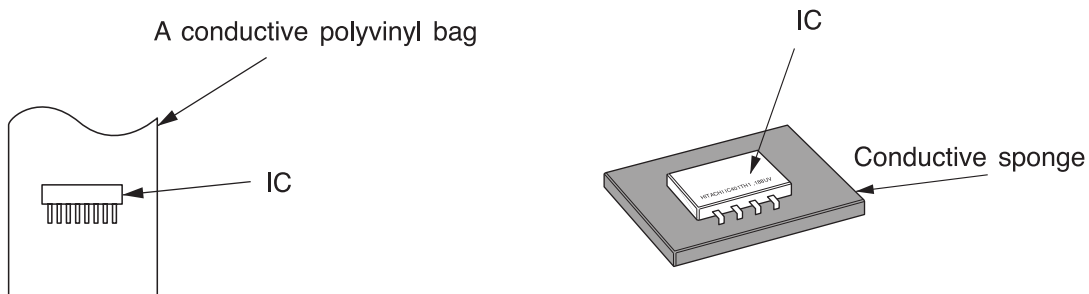

Fig. 1. Conductive container

- (2) When any part is handled uncovered (in counting, packing and the like), the handling person must always use himself as a body earth. (Make yourself a body earth by passing $1M\Omega$ earth resistance through a ring or bracelet).
- (3) Be careful not to touch the parts with your clothing when you hold a part even if a body earth is being taken.
- (4) Be sure to place a part on a metal plate with grounding.
- (5) Be careful not to fail to turn off power when you repair the printed circuit board. At the same time, try to repair the printed circuit board on a grounded metal plate.

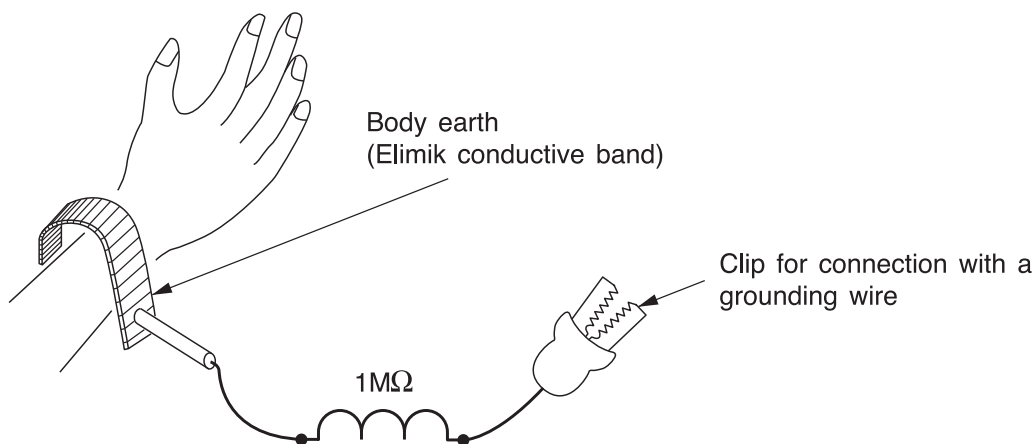

Fig. 2. Body Earth

(6) Use a three wire type soldering iron including a grounding wire.

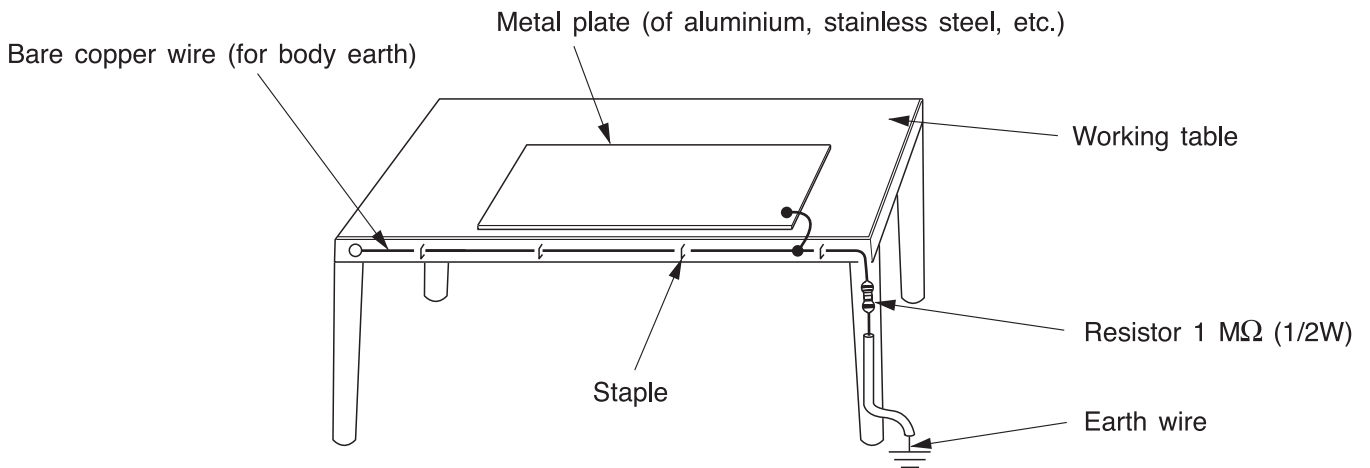

Fig. 3. Grounding of the working table

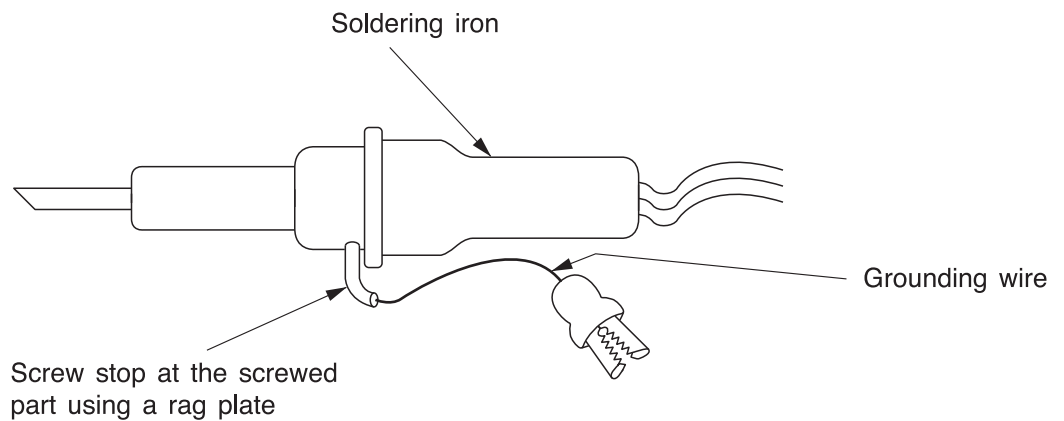

Fig. 4. Grounding a solder iron

Use a high insulation mode (100V, 10MΩ or higher) when ordinary iron is to be used.

(7) In checking circuits for maintenance, inspection or some others, be careful not to have the test probes of the measuring instrument short circuit a load circuit or the like.

 **CAUTION**

1. In quiet or stop operation, slight flowing noise of refrigerant in the refrigerating cycle is heard occasionally, but this noise is not abnormal for the operation.
2. When it thunders nearby, it is recommended to stop the operation and to disconnect the power cord plug from the power outlet for safety.
3. In the event of power failure, the airconditioner will restart automatically in the previously selected mode once the power is restored. In the event of power failure during TIMER operation, the airconditioner will not start automatically. Re-press START/STOP button after 3 minutes from when unit stopped or power recovery.
4. If the room air conditioner is stopped by adjusting thermostat, or miss operation, and re-start in a moment, there is occasion that the cooling and heating operation does not start for 3 minutes, it is not abnormal and this is the result of the operation of IC delay circuit. This IC delay circuit ensures that there is no danger of blowing fuse or damaging parts even if operation is restarted accidentally.
5. This room air conditioner should not be used at the cooling operation when the outside temperature is below $-18^{\circ}\text{C}(-0.4^{\circ}\text{F})$.
6. This room air conditioner (the reverse cycle) should not be used when the outside temperature is below $-25^{\circ}\text{C}(-13^{\circ}\text{F})$
If the reverse cycle is used under this condition, the outside heat exchanger is frosted and efficiency falls.
7. When the outside heat exchanger is frosted, the frost is melted by operating the hot gas system, it is not trouble that at this time fan stops and the vapour may rise from the outside heat exchanger.

SPECIFICATIONS

MODEL	RAS-PH18PHLAE RAS-PH24PHLAE	RAC-PH18WHLAE	RAC-PH24WHLAE
FAN MOTOR	38W	120W	
FAN MOTOR CAPACITOR	NO	NO	
FAN MOTOR PROTECTOR	NO	NO	
COMPRESSOR	NO	ATD186UKQA9LT6C	
COMPRESSOR MOTOR CAPACITOR	NO	NO	
OVERLOAD PROTECTOR	NO	YES	
OVERHEAT PROTECTOR	NO	YES	
FUSE (for MICROPROCESSOR)	NO	5.0A	
POWER RELAY	NO	G4A	
POWER SWITCH	NO	NO	
TEMPORARY SWITCH	YES	NO	
SERVICE SWITCH	NO	YES	
TRANSFORMER	NO	NO	
VARISTOR	NO	ERZV9V431	
NOISE SUPPRESSOR	NO	YES	
THERMOSTAT	YES(IC)	YES(IC)	
REMOTE CONTROL SWITCH (LIQUID CRYSTAL)	YES	NO	
REFRIGERANT CHARGING VOLUME (Refrigerant R410A)	UNIT	----	4.74 lb (2.15kg)
	PIPES	----	MAX. 98.5ft (30m) Min 9.8ft(3m)

In case the pipe length is more than 49.2ft(15m), add refrigerant R410A at 10gram per every meter exceeds.

INDOOR MODEL : RAS-PH18PHLAE, RAS-PH24PHLAE

Direction of Piping

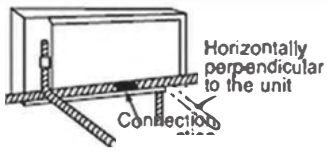

There are 6 directions allowed, namely, horizontally perpendicular to the unit, vertically down from right, horizontally out from right, horizontally out to left, horizontally out to right, vertically down from left.
Don't form the piping downward at the left of the unit.

Figure showing the Installation of Indoor

CAUTION

- The difference in height between the indoor and outdoor unit should be kept max. 65.6ft (20m).
- The connecting pipe, no matter big or small, should all be insulated with insulation pipe and then wrapped with plastic tape. (The insulator will deteriorate if it is not wrapped with tape).

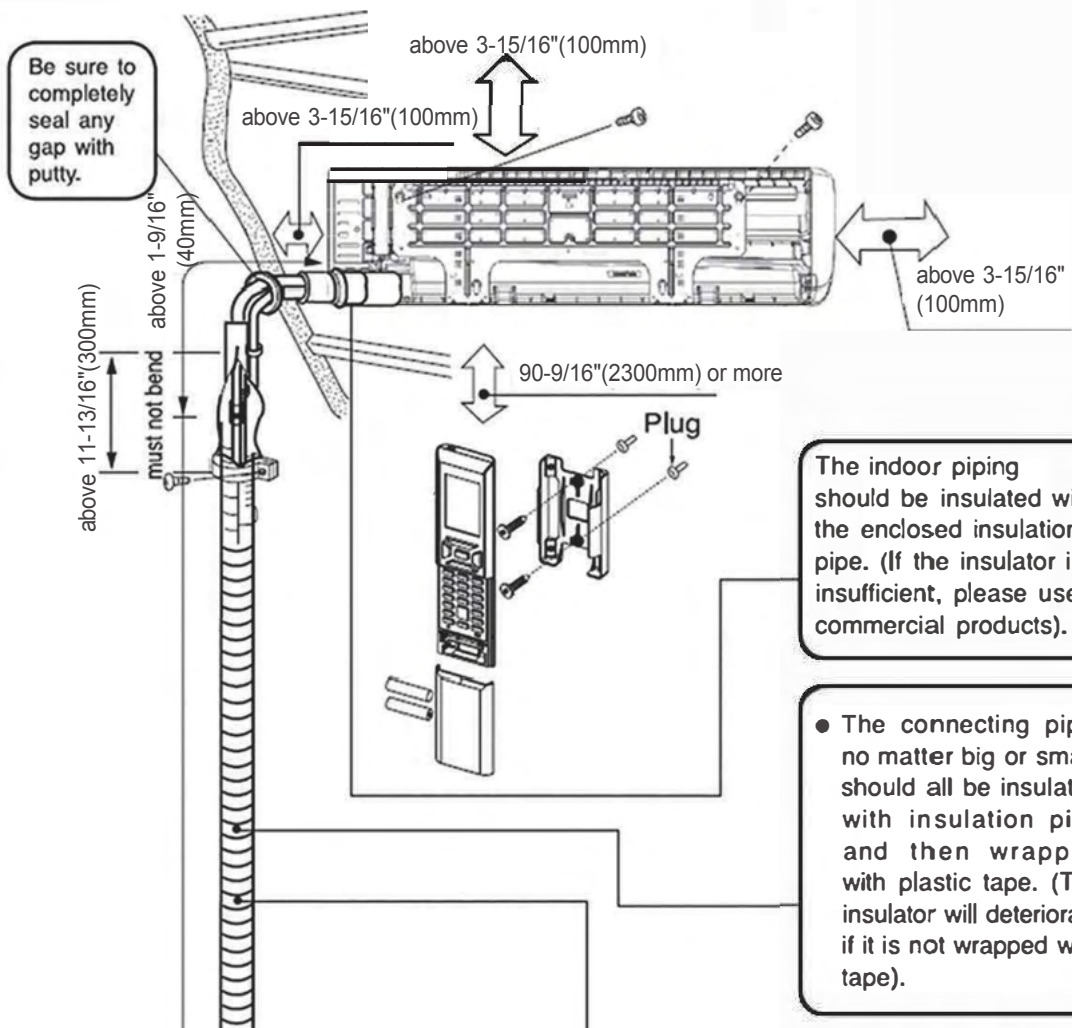

The indoor piping should be insulated with the enclosed insulation pipe. (If the insulator is insufficient, please use commercial products).

- The connecting pipe, no matter big or small, should all be insulated with insulation pipe and then wrapped with plastic tape. (The insulator will deteriorate if it is not wrapped with tape).

The connection of insulated drain hose.
inner diameter $\phi 5/8"$ (16mm)
Please use insulated drain hose for the indoor piping (commercial product).

OUTDOOR MODEL : RAC-PH18WHLAE, RAC-PH24WHLAE

⚠ CAUTION

- A brazed, welded or mechanical connection shall be made before opening the valves to permit refrigerant to flow between the refrigerating system parts. A vacuum valve shall be provided to evacuate the interconnecting pipe and/or any uncharged refrigerating system.
- Mechanical connectors used indoors shall comply with ISO 14903. When mechanical connectors are reused indoors, sealing parts shall be renewed. When flare joints are reused indoors, the flare part shall be re-fabricated.
- Refrigerant tubing shall be protected or enclosed to avoid damage.

⚠ WARNING

- Flare connection only at outside of building

⚠ CAUTION

- Installation of pipe length less than minimum pipe length requirement 9-27/32ft(3m) may generate an abnormal sound.

⚠ CAUTION

- The difference in height between the indoor and outdoor unit should be kept max. 65-39/64ft(20m).
- The connecting pipe, no matter big or small, should all be insulated with insulation pipe and then wrapped with plastic tape. (The insulator will deteriorate if it is not wrapped with tape).

Refrigerant piping must be protected from physical damage. Install a plastic cover or equivalent.

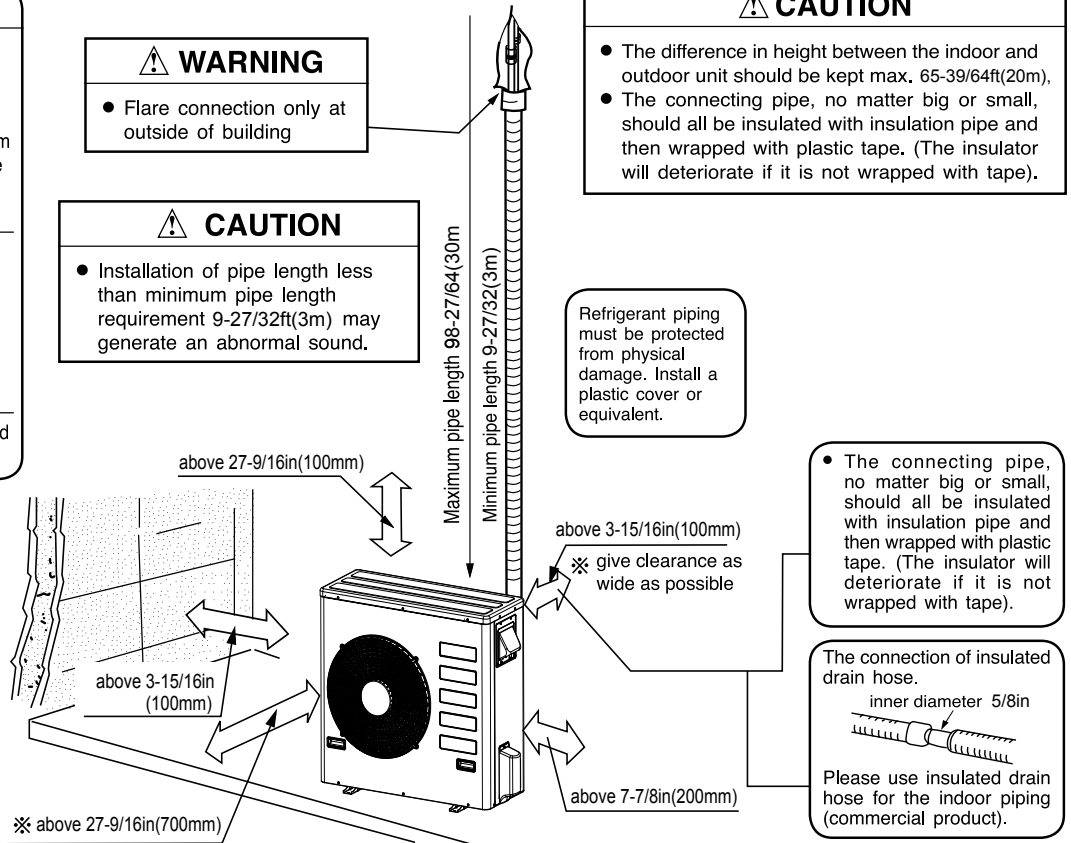

Important Notice

- Johnson Controls-Hitachi Air Conditioning North America LLC pursues a policy of continuing improvement in design and performance in its products. As such, Johnson Controls-Hitachi Air Conditioning North America LLC reserves the right to make changes at any time without prior notice.
- Johnson Controls-Hitachi Air Conditioning North America LLC cannot anticipate every possible circumstance that might involve a potential hazard.
- This inverter air conditioning unit is designed for standard air conditioning applications only. Do not use this unit for anything other than the purposes for which it was intended.
- The installer and system specialist shall safeguard against leakage in accordance with local codes. The following standards may be applicable, if local regulations are not available. International Organization for Standardization: (ISO 5149 or European Standard, EN 378). No part of this manual may be reproduced in any way without the expressed written consent of Johnson Controls-Hitachi Air Conditioning North America LLC.
- This air conditioning unit will be operated and serviced in the United States of America and comes with a full complement of the appropriate Safety, Danger, and Caution, Warnings.
- If you have questions, please contact your distributor or contractor.
- This manual provides common descriptions, basic and advanced information to maintain and service this air conditioning unit which you operate as well for other models.
- This air conditioning unit has been designed for a specific temperature range. For optimum performance and long life, operate this unit within the range limits.
- This manual should be considered as a permanent part of the air conditioning equipment and should remain with the air conditioning equipment.

Product Inspection upon Arrival

1. Upon receiving this product, inspect it for any damages incurred in transit. Claims for damage, either apparent or concealed, should be filed immediately with the shipping company.
2. Check the model number, electrical characteristics (power supply, voltage, and frequency rating), and any accessories to determine if they agree with the purchase order.
3. The standard utilization for this unit is explained in these instructions. Use of this equipment for purposes other than what it designed for is not recommended.
4. Please contact your local agent or contractor as any issues involving installation, performance, or maintenance arise. Liability does not cover defects originating from unauthorized modifications performed by a customer without the written consent of Johnson Controls-Hitachi Air Conditioning North America LLC. Performing any mechanical alterations on this product without the consent of the manufacturer will render your warranty null and void.

California Proposition 65



Proposition 65: This product contains chemicals known to the state of California to cause cancer, birth defects, and other reproductive harm. For more information, go to www.P65Warnings.ca.gov



SAFETY PRECAUTION

- Please read the “Safety Precaution” carefully before operating the unit to ensure correct usage of the unit.
- To prevent personal injury or property damage, read this section carefully before you use this product, and be sure to comply with the following safety precautions. Incorrect operation due to failure to follow the instructions may cause harm or damage, the seriousness of which is classified as follows:

⚠ WARNING

This mark warns of death or serious injury.

⚠ CAUTION

This mark warns of injury or damage to property.

 This mark denotes an action that is PROHIBITED.

 This mark denotes an action that is COMPULSORY.

- Please keep this manual after reading.

WARNING

⚠
 W
 A
 R
 N
 I
 N
 G

- Please use ground wiring.
Connect the power supply and the ground wiring to the terminals in the electrical box.
Ground wiring must be securely connected.
Use a GFCI (Ground Fault Circuit Interrupter).
Failure to use a GFCI can result in electric shock or fire.
- Be sure to use the specified piping set for R410A. Otherwise, this may result in broken copper pipes or faults.
- Should abnormal situation arises (like burning smell), please stop operating the unit and turn off the circuit breaker. Contact your agent. Fault, short circuit or fire may occur if you continue to operate the unit under abnormal situation.
- Please contact your agent for maintenance. Improper self maintenance may cause electric shock and fire.
- Please contact your agent if you need to remove and reinstall the unit. Electric shock or fire may occur if you remove and reinstall the unit yourself improperly.
- If the supply cord is damaged, it must be replaced by the special cord obtainable at authorized service/ parts centers.
- Do not insert a finger, a rod or other objects into the air outlet or inlet. As the fan is rotating at a high speed, it will cause injury. Before cleaning, be sure to stop the operation and turn the breaker OFF.
- Do not use any conductor as fuse wire, this could cause fatal accident.
- During thunder storm, disconnect and turn off the circuit breaker.

- Do not reconstruct the unit.
Water leakage, fault, short circuit or fire may occur if you reconstruct the unit by yourself.
- Please ask your sales agent or qualified technician for the installation of your unit. Water leakage, short circuit or fire may occur if you install the unit by yourself.
- Spray cans and other combustibles should not be located within a meter 3.28ft(1m) of the air outlets of both indoor and outdoor units.
As a spray can's internal pressure can be increased by hot air, a rupture may result.



CAUTION

⚠
 C
 A
 U
 T
 I
 O
 N

- A circuit breaker should be installed depending on the mounting site of the unit. Without a circuit breaker, the danger of electric shock exists.
- Do not install near location where there is flammable gas. The outdoor unit may catch fire if flammable gas leaks around it.
- Please ensure a smooth flow of condensate when installing the condensate hose.
- Do not install the indoor unit in a machine shop or kitchen where vapor from oil or its mist flows to the indoor unit. The oil will deposit on the heat exchanger, thereby reducing the indoor unit performance and may deform and in the worst case, break the plastic parts of the indoor unit.

PRECAUTIONS DURING OPERATION

- The product shall be operated under the manufacturer specification and not for any other intended use.



- Do not attempt to operate the unit with wet hands, this could cause fatal accident.

- When operating the unit with burning equipments, regularly ventilate the room to avoid insufficient oxygen.



- Do not direct the cool air coming out from the air-conditioner panel to face household heating apparatus as this may affect the working of apparatus such as the electric kettle, oven etc.

- Please ensure that outdoor mounting frame is always stable, firm and without defect. If not, the outdoor unit may collapse and cause danger.



- Do not splash or direct water to the body of the unit when cleaning it as this may cause short circuit.

- Do not use any aerosol or hair sprays near the indoor unit. This chemical can adhere on heat exchanger fin and block the flow of condensate to the condensate pan. Condensate might drip on the fan and cause droplets to occasionally drip from the indoor unit.



C
A
U
T
I
O
N



- Please switch off the unit and turn off the circuit breaker during cleaning, the high-speed fan inside the unit may cause danger.

- Turn off the circuit breaker if the unit is not to be operated for a long period.



- Do not climb on the outdoor unit or put objects on it.

- Do not put water container (like vase) on the indoor unit to avoid water dripping into the unit. Dripping water will damage the insulator inside the unit and cause a short circuit.



- Do not place plants directly under the air flow as it is bad for the plants.

- When operating the unit with the door and windows opened, (the room humidity is always above 80%) and with the louver facing down or moving automatically for a long period of time, condensate will condense on the louver and drips down occasionally. This will wet your furniture. Therefore, do not operate under such condition for a long time.

- If the amount of heat in the room is above the cooling or heating capability of the unit (for example: more people entering the room, using heating equipments and etc.), the preset room temperature cannot be achieved.

- This appliance can be used by children aged from 8 years and above and persons with reduced physical, sensory or mental capabilities or lack of experience and knowledge if they have been given supervision or instruction concerning use of the appliance in a safe way and understand the hazards involved.
Children shall not play with the appliance. Cleaning and user maintenance shall not be made by children without supervision.

NAMES AND FUNCTIONS OF EACH PART

INDOOR UNIT

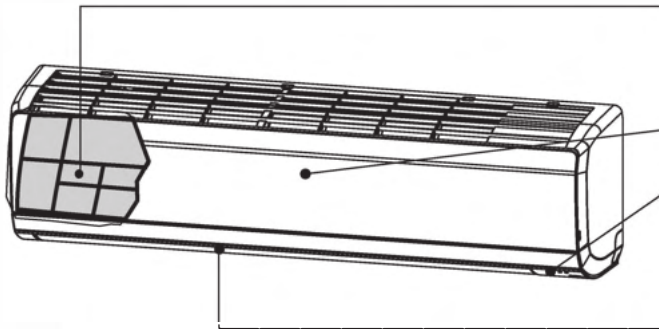

Pre-filter

To prevent dust from coming into the indoor unit.

Front panel

Indoor unit indicators

LED light shows the operating mode.

Horizontal deflector • Vertical deflector (Air Outlet)

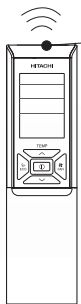

Remote controller

Send out operation signal to the indoor unit. So as to operate the whole unit.

Please refer to the Remote Manual provided for functions and operation details.

OUTDOOR UNIT

Air outlet

When “heating” operation is performed, cool air blows and when “cooling” or “dehumidifying” operation is performed, warm air blows.

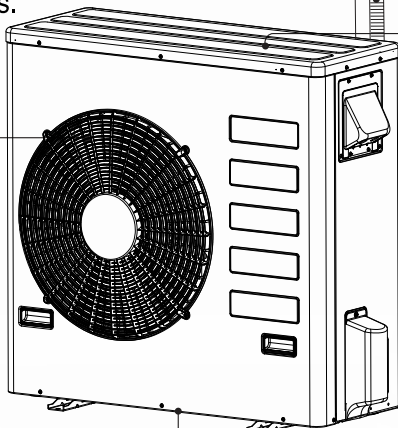

Drain hose

Drains the dehumidified water from the indoor unit to the outdoor during “cooling” or “dehumidifying” operation.

Piping and Wiring

Air inlets (Rear and left sides)

Drain port

⚠ CAUTION

- When heating operation, drain or defrosted water flows out from outdoor unit. Don't close drain outlet portion in chilly area so as not to freeze these.

MODEL NAME AND DIMENSIONS

MODEL	WIDTH inch(mm)	HEIGHT inch(mm)	DEPTH inch(mm)
RAC-PH18PHLAE, RAC-PH24PHLAE	43.3"(1100)	11.81"(300)	10.23"(260)
RAC-PH18WHLAE, RAC-PH24WHLAE	37.40"(950)	37.20"(945)	14.57"(370)

INDOOR UNIT INDICATORS

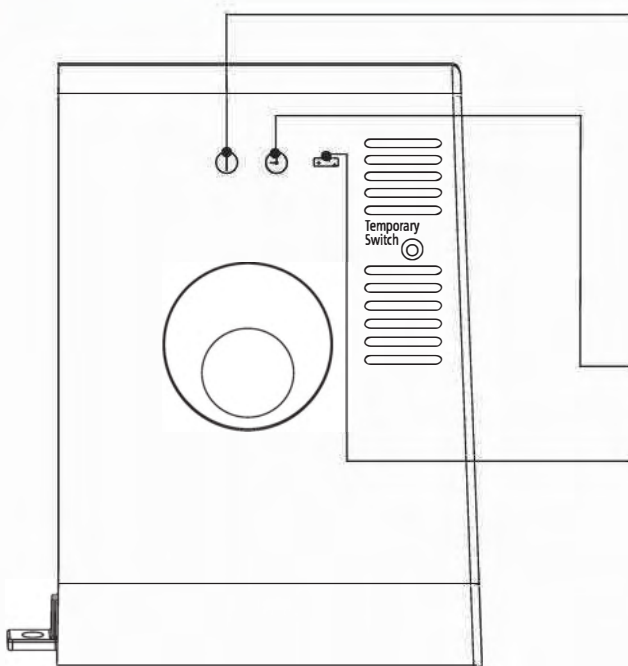

OPERATION LAMP

This lamp lights during operation.

The OPERATION LAMP flashes/dimming in the following cases during heating.

(1) During preheating

For about 2–3 minutes after starting up.

(2) During defrosting

Defrosting will be performed about once every one hour when frost forms on the heat exchanger of the outdoor unit, for 5–10 minutes each time.

TIMER LAMP

This lamp lights when the timer is working.

FROST WASH LAMP

This lamp lights when the Frost Wash function is in operation. If the auto Frost Wash function is canceled and operation is stopped, when the device is operated for a total of about 42 hours, the Frost Wash indicator blinks to indicate that it is time to operate the manual Frost Wash function.

(not applicable for Multi split connection)

OPERATION INDICATORS

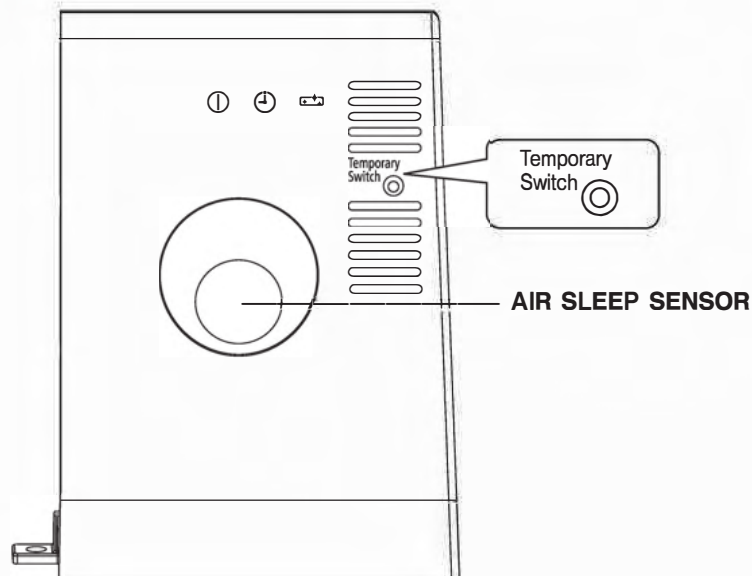

TEMPORARY SWITCH

Use this switch to start and stop when the remote controller does not work. [Use non-conductor stick (example: toothpick)]

- By pressing the temporary switch, the operation is done in automatic mode.
- When the operation is done using the temporary switch after the power source is turned off and turn on again, the operation is done in automatic mode.

THE IDEAL WAYS OF OPERATION

Suitable Room Temperature



⚠ Warning
Freezing temperature is bad for health and a waste of electric power.

Install curtain or blinds



It is possible to reduce heat entering the room through windows.

Ventilation

⚠ Caution
Do not close the room for a long period of time. Occasionally open the door and windows to allow the entrance of fresh air.



Effective Usage Of Timer

At night, please use the "OFF or ON timer operation mode", together with your wake up time in the morning. This will enable you to enjoy a comfortable room temperature. Please use the timer effectively.



Do Not Forget To Clean The Pre-Filter

Dusty pre-filter will reduce the air volume and the cooling efficiency. To prevent from wasting electric energy, please clean the pre-filter every 2 weeks.

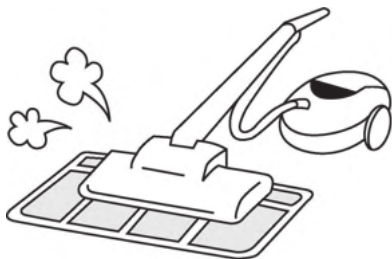

Please Adjust Suitable Temperature For Baby And Children

Please pay attention to the room temperature and air flow direction when operating the unit for baby, children and old folks who have difficulty in movement.



FOR USER'S INFORMATION

The Air Conditioner And The Heat Source In The Room

⚠ Caution

If the amount of heat in the room is above the cooling capability of the air conditioner (for example: more people entering the room, using heating equipments and etc.), the preset room temperature cannot be achieved.

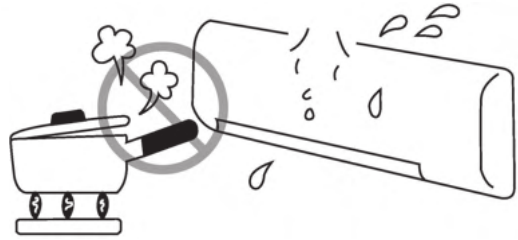

Not Operating For A Long Time

When the indoor unit is not to be used for a long period of time, please switch off the power from the mains. If the power from mains remains "ON", the indoor unit still consumes about 3W in the operation control circuit even if it is in "OFF" mode.

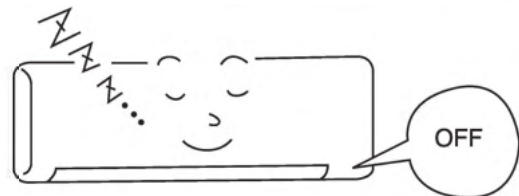

When Lightning Occurs

⚠ Warning

To protect the whole unit during lightning, please stop operating the unit and remove the plug from the socket.

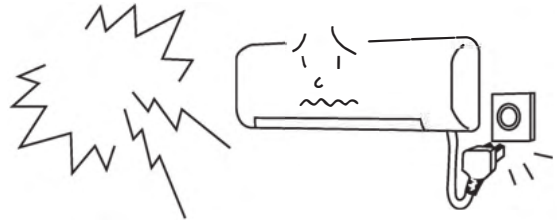

Interference From Electrical Products

⚠ Caution

To avoid noise interference, please place the indoor unit and its remote controller at least 3.28ft (1m) away from electrical products.

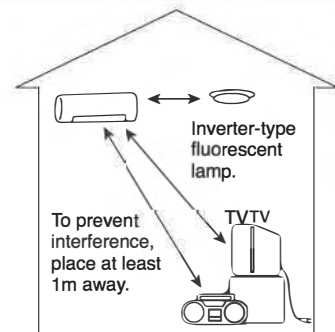

ATTACHING THE AIR PURIFYING FILTERS

- 1** **Open the front panel**
- Pull up the front panel by holding it at both sides with both hands.

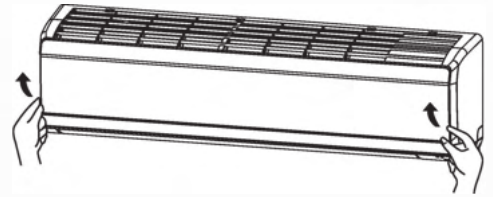

- 2** **Remove the Pre-filter**
- Push upward to release the claws and pull out the Pre-filter.

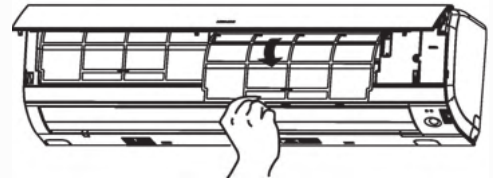

- 3** **Attaching the air purifying filters**
- Attach the air purifying filters to the frame by gently compress its both sides and release after insertion into Pre-filter frame.

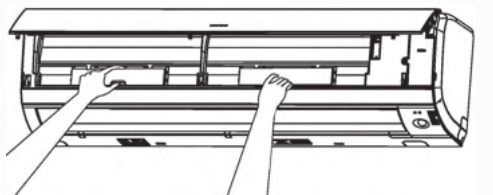
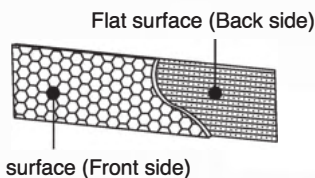

CAUTION

Do not bend the air purifying filter as it may cause damage to the structure.

Please do not smell direct from source of filter.

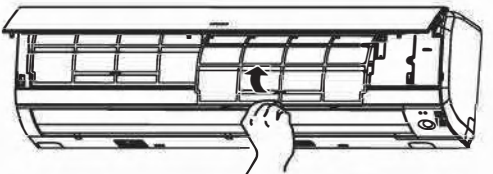

- 4** **Attach the Pre-filters**
- Attach the Pre-filters by ensuring that the surface written "FRONT" is facing front.
 - After attaching the Pre-filters, push the front panel at three arrow portions as shown in figure and close it.

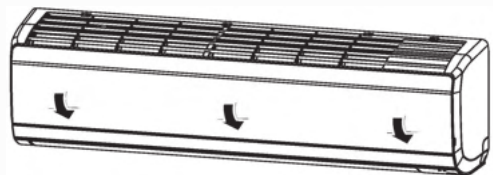

NOTE

- In case of removing the air purifying filters, please follow the above procedures.
- The cooling capacity is slightly weakened and the cooling speed becomes slower when the air purifying filters are used. So, set the fan speed to "HIGH" when using it in this condition.
- The air purifying filters are not washable. It is recommended to use vacuum to clean. It can be used for 1 year. When you want to renew it, please ask your sales agent.
Type number for this air purifying filter is <SPX-CFH22AC25>. Please use this number for ordering when you want to replace it.
- Do not use detergent on the air purifying filter as some detergent may deteriorate the air purifying filter electrostatic performance.



MAINTENANCE

CAUTION

Cleaning and maintenance must be carried out only by qualified service personnel. Before cleaning, stop operation and switch off the power supply.

1. PRE-FILTER

Clean the Pre-filter, as it removes dust inside the room. In case the Pre-filter is full of dust, the air flow will decrease and the cooling capacity will be reduced. Further, noise may occur. Be sure to clean the Pre-filter following the procedure below.

PROCEDURE

- 1 Open the front panel and remove the Pre-filter
 - Gently lift and remove the air purifying filters from the air purifying filter frame.

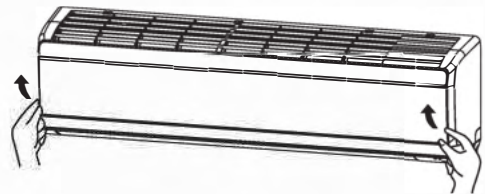

- 2 Vacuum dust from the Pre-filter and air purifying filter using vacuum cleaner. If there is too much dust, rinse under running tap water and gently brush it with soft bristle brush. Allow filters to dry in shade.

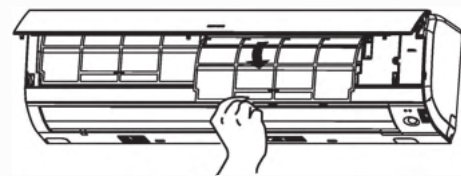

- 3
 - Re-insert the air purifying filter to the filter frame. Set the Pre-filter with "FRONT" mark facing front, and slot them into the original state.
 - After attaching the Pre-filters, push the front panel at three arrow portions as shown in figure and close it.

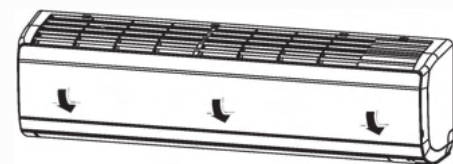

NOTE:

- Air purifying filter should be cleaned every month or sooner if noticeable loading occurs. When used overtime, it may lose its deodorizing function. For maximum performance, it is recommended to replace it every 1 year depending on application requirements.

CAUTION

- Do not operate the air conditioner without Pre-filter. Dust may enter the air conditioner and fault may occur.
- Do not wash with hot water at more than 104°F(40°C). The Pre-filters may shrink.
- When washing it, shake off moisture completely and dry it in the shade; do not expose it directly to the sun. The Pre-filters may shrink.
- Do not use detergent on the Pre-filter as some detergent may deteriorate the Pre-filter electrostatic performance.

2. CLEANING OF FRONT PANEL

- Remove the front panel and wash with clean water. Wash it with a soft sponge. After using neutral detergent, wash thoroughly with clean water.
- When front panel is not removed, wipe it with a soft dry cloth. Wipe the remote controller thoroughly with a soft dry cloth.
- Wipe the water thoroughly. If water remains at indicators or signal receiver of indoor unit, it causes trouble.

Method of removing the front panel.

Be sure to hold the front panel with both hands to detach and attach it.



Removing the Front Panel



- When the front panel is fully opened with both hands, push the right arm to the outside to release it, and while closing the front panel slightly, pull it out forward.

Attaching the Front Panel

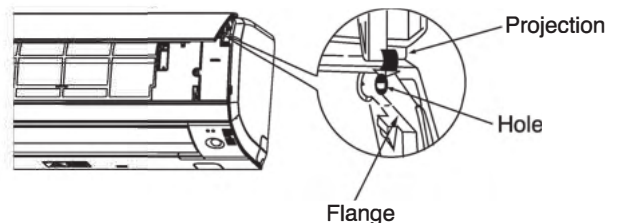

- Move the projections of the left and right arms into the Flanges in the unit and securely insert them into the holes.

CAUTION

- Never use hot water (above 104°F(40°C)), benzene, gasoline, acid, thinner or a brush, because they will damage the plastic surface and the coating.



⚠ CAUTION



- Please use ground wiring.
Do not place the ground wiring near water or gas pipes, lightning-conductor, or the ground wiring of telephone. Improper installation of ground wiring may cause electric shock.
- A circuit breaker should be installed depending on the mounting site of the unit. Without a circuit breaker, the danger of electric shock exists.

IMPORTANT

The wires in this mains lead are coloured in accordance with the following code:

- Green-and-yellow : Earth/Ground
- White : Neutral
- Black : Line

As the colours of the wires in the mains lead of this appliance may not correspond with the coloured markings identifying the terminals in your plug, proceed as follows:

The wire which is coloured green-and-yellow must be connected to the terminal in the plug which is marked with the letter E or by the earth symbol (⊕) or coloured green or green-and-yellow.

The wire which is coloured white must be connected to the terminal which is marked with the letter N or coloured black.

The wire which is coloured black must be connected to the terminal which is marked with the letter L or coloured red.

NOTE

If the supply cord is damaged, it must be replaced with the new cord obtainable at authorized service parts centers.

⚠ CAUTION

Cleaning and maintenance must be carried out only by qualified service personnel. Before cleaning, stop operation and switch off the power supply.

REGULAR INSPECTION

PLEASE CHECK THE FOLLOWING POINTS BY QUALIFIED SERVICE PERSONNEL EITHER EVERY HALF YEARLY OR YEARLY. CONTACT YOUR SALES AGENT OR SERVICE SHOP.

1		Is the ground wiring disconnected or broken?
2		Is the mounting frame seriously affected by rust and is the outdoor unit tilted or unstable?

AFTER SALE SERVICE AND WARRANTY

WHEN ASKING FOR SERVICE, CHECK THE FOLLOWING POINTS.

CONDITION	CHECK THE FOLLOWING POINTS
<p>If the remote controller is not transmitting a signal. (Remote controller display is dim or blank.)</p>	<ul style="list-style-type: none"> ● Do the batteries need replacement? ● Is the polarity of the inserted batteries correct?
<p>When it does not operate</p>	<ul style="list-style-type: none"> ● Is the fuse all right? ● Is the voltage extremely high or low? ● Is the circuit breaker "ON"? ● Is the setting of operation mode different from other indoor units?
<p>When it does not cool well When it does not heat well</p>	<ul style="list-style-type: none"> ● Is the pre-filter blocked with dust? ● Does sunlight fall directly on the outdoor unit? ● Is the air flow of the outdoor unit obstructed? ● Are the doors or windows opened, or is there any source of heat in the room? ● Is the set temperature suitable? ● Are the air inlets or air outlets of indoor and outdoor units blocked? ● Is the fan speed "LOW" or "SILENT"?



Notes

- In quiet operation or stopping the operation, the following phenomena may occasionally occur, but they are not abnormal for the operation.
 - (1) Slight flowing noise of refrigerant in the refrigerating cycle.
 - (2) Slight rubbing noise from the fan casing which is cooled and then gradually warmed as operation stops.
- The odor will possibly be emitted from the room air conditioner because the various odor, emitted by smoke, foodstuffs, cosmetics and so on, sticks to it. So the pre-filter and the evaporator regularly must be cleaned to reduce the odor.

- Please contact your sales agent immediately if the air conditioner still fails to operate normally after the above inspections. Inform your agent of the model of your unit, production number, date of installation. Please also inform him regarding the fault.
- Power supply shall be connected at the rated voltage, otherwise the unit will be broken or could not reach the specified capacity.

NOTE:

- If the supply cord is damaged, it must be replaced by the special cord obtainable at authorized service parts centers.
- On switching on the equipment, particularly when the room light is dimmed, a slight brightness fluctuation may occur. This is of no consequence.
The conditions of the local Power Supply Companies are to be observed.

PREPARATION BEFORE OPERATION

■ To set the batteries

1. Slide the cover to take it off.
2. Set two dry batteries type AAA/LR03 (alkaline).
The batteries must be placed in the position of "+" and "-" polar.
3. Reinstall the cover of battery box.
4. Press Reset button.

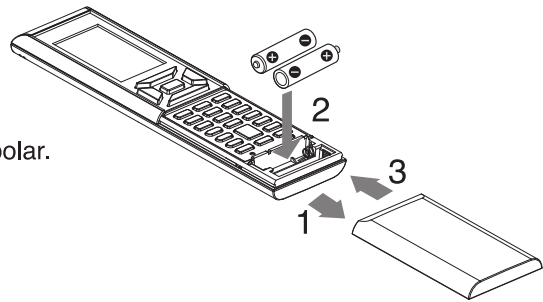

■ To mount the remote controller holder to the wall

1. Choose a place from where the signals can reach the unit.
2. Mount the remote controller holder to a wall, a pillar or similar location with the provided screws.
3. Place the remote controller in the remote controller holder.

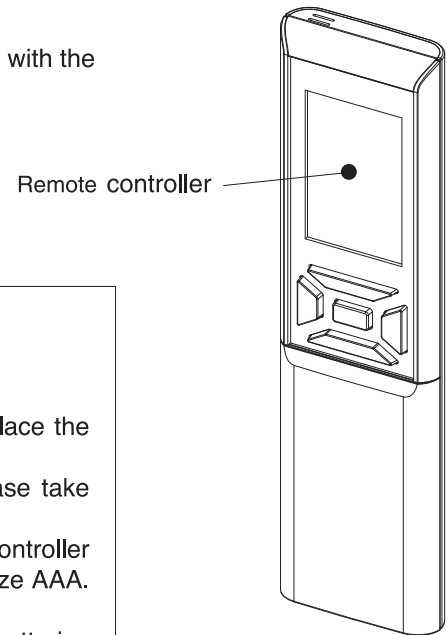

NOTES

Notes for the batteries

- When replacing the batteries, use the same type of batteries to replace the old batteries.
- When the remote controller is not being used for a long time, please take out the batteries.
- The batteries will last for approximately 1 year. When the remote controller is not being used for a long time, replace both batteries with new size AAA, LR03 (alkaline).
- The provided batteries are only for the initial use. The lifespan of the batteries may vary depending on the manufactured date of the air conditioner.

Notes for the remote controller

- Never expose the remote controller to direct sunlight.
- Dust on the signal transmitter or receiver will become less sensitive. Wipe off dust with soft cloth.
- Signal communication may be interfered if an electronic-starter-type fluorescent lamp (such as inverter-type lamps) is in the room.
- If the remote controller signals happen to operate another appliance, move that appliance to somewhere else.
- When the remote controller is not in use, please close the slide cover to prevent damage.

PREPARATION BEFORE OPERATION

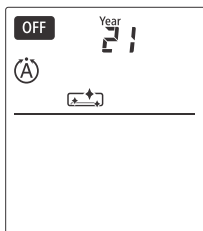
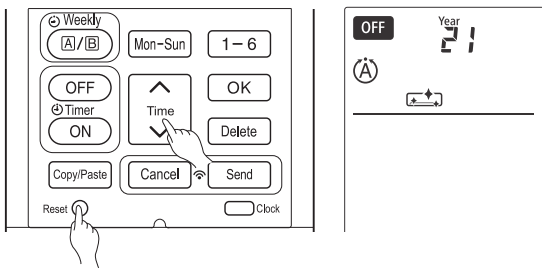

■ To set date and clock.

1. Press Reset (Reset) button to set date and clock. "Year" blinks.
 2. Press (Time) button to set year.
 3. Press Clock (Clock) button. "Day" and "Month" blink.
 4. Press (Time) button to set day and month.
 5. Press Clock (Clock) button. "CLOCK" blinks.
 6. Press (Time) button to set the clock.
 7. Press Clock (Clock) button.
- Date and clock are set.

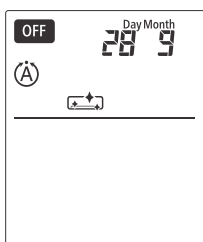
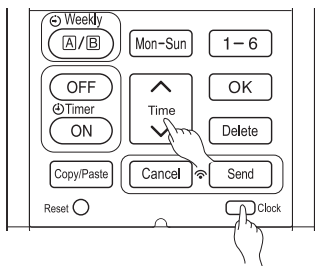

To modify the date and clock, press Clock (Clock) button. Please refer steps 1 to 7.

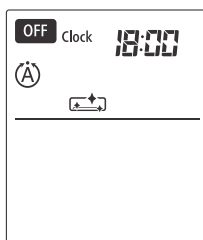
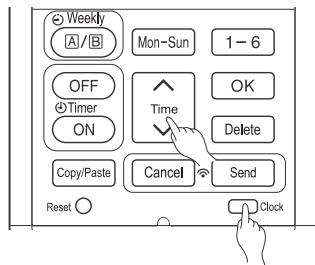

Date and clock need to be set again after changing batteries.

After changing the batteries,

1. Press Reset (Reset) button.
2. Point remote controller towards indoor unit and press (INFO) button.
3. The date and clock from indoor unit will be transmitted.

- Date and clock will not be transmitted from indoor unit when below conditions occur:
 - When there is a power failure.
 - When power supply is disconnected by user (unit is not in STANDBY MODE).

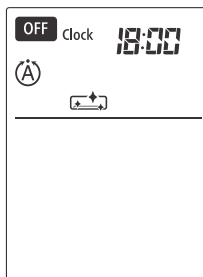
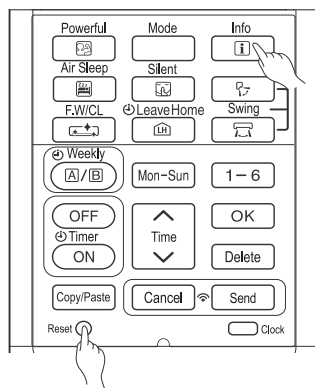

NOTE

Note for setting the date and clock.

- If the date and clock are not set, the ON-timer, OFF-timer and Weekly Timer cannot be set.
- If the date and clock are not set correctly, the ON-timer, OFF-timer and Weekly Timer will not operate correctly.
- When the ON-timer, OFF-timer and Weekly Timer are set, the date and clock cannot be changed. If there is a need to change the date and clock, ON-timer, OFF-timer and Weekly Timer will be cancelled.

Temperature switching

- The temperature unit switch on this remote controller can be switched between Fahrenheit and Celcius.
- The default unit temperature display is in Fahrenheit.
- The temperature unit will be maintained as it is even when the battery is replaced or operation is reset.
- Setting for date and clock shall be set first before setting the Weekly Timer operation.

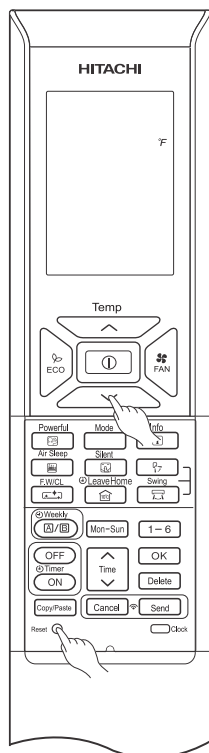

Fahrenheit

Method to select Fahrenheit

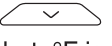
1. While pressing Reset  (Reset) button, press  (Temp Down) button.
2. Reset Screen appears and disappears. After that, °F is displayed on the LCD.

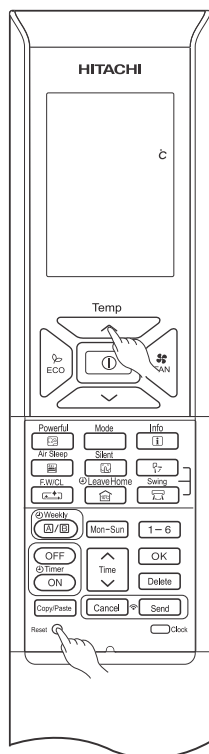

Celcius

Method to select Celcius

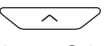
1. While pressing Reset  (Reset) button, press  (Temp Up) button.
2. Reset Screen appears and disappears. After that, °C is displayed on the LCD.

NAMES AND FUNCTIONS OF REMOTE CONTROLLER

REMOTE CONTROLLER

- User can control room air conditioner by using remote controller. The distance between signal sender and receiving window is about 23ft (7m). If indoor lighting is controlled electronically, the range of control may be shorter.

This remote controller can be mounted on a wall using the fixture provided. Before mounting it, make sure the indoor unit can be controlled from the remote controller.

- Handle the remote controller with care. Dropping or wet remote controller may compromise its signal transmission capability.
- After new batteries are replaced into the remote controller, it takes approximately 10 seconds to respond to commands and operate.
- When remote controller is not in use for about 3 minutes during OFF condition, indicated by **OFF** on the display, the LCD will turn off.
- During clock setting, the LCD will turn off about 10 minutes later if the remote controller is not in use.
- When pressing any button, the LCD will turn on.
- The LCD will not turn off during TIMER setting.

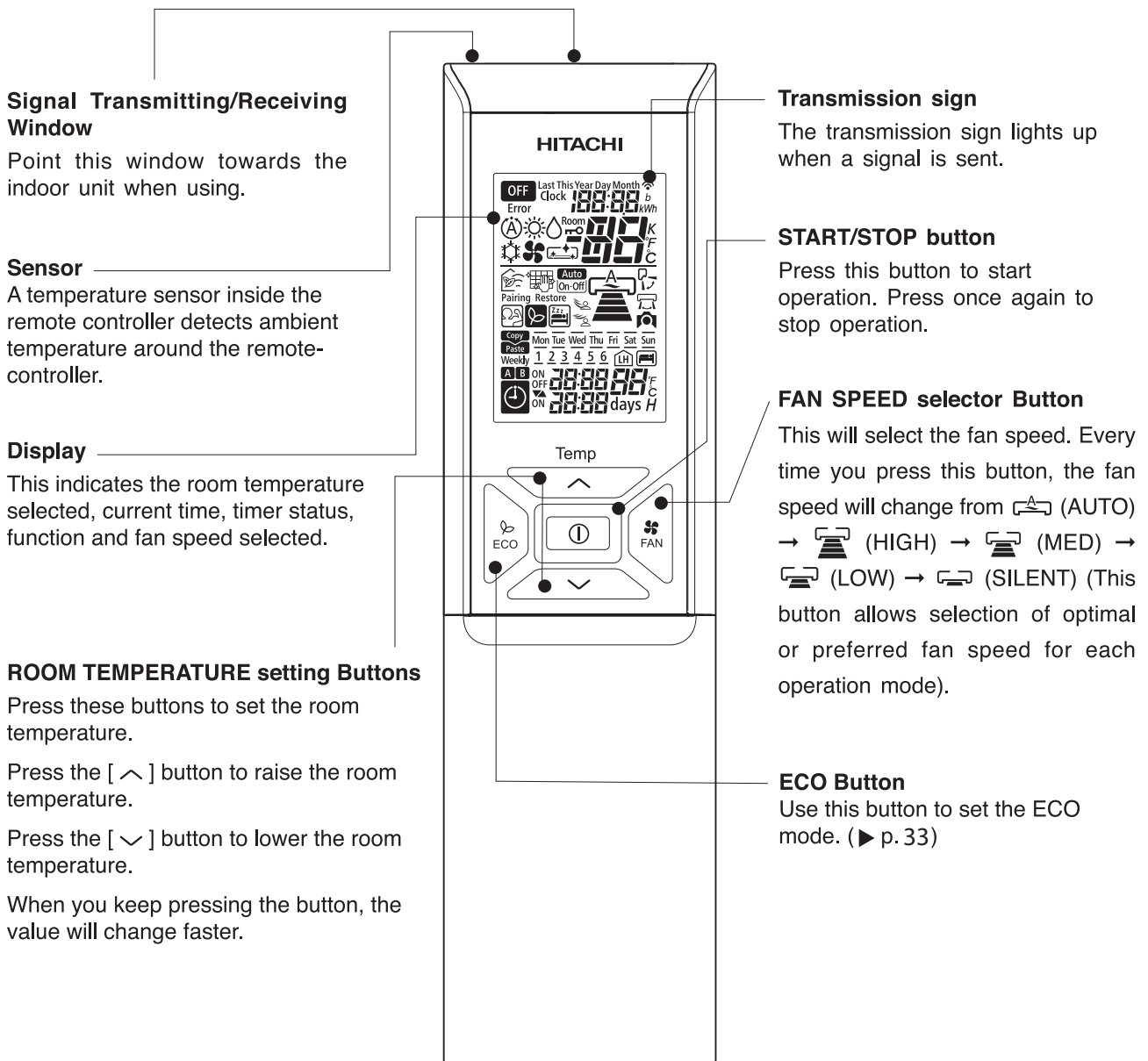

NAMES AND FUNCTIONS OF REMOTE CONTROLLER

POWERFUL Button

Use this button to set the POWERFUL mode. (▶ p. 31)

AIR SLEEP Button

Use this button to set a comfortable air sleep temperature in the room or start operation. (▶ p. 41)

FROST WASH / CLEAN Button

(▶ p. 36)

LEAVE HOME Button

(▶ p. 35)

SILENT Button

Use this button to set the SILENT mode. (▶ p. 32)

ON / OFF TIMER setting Buttons

(▶ p. 40)

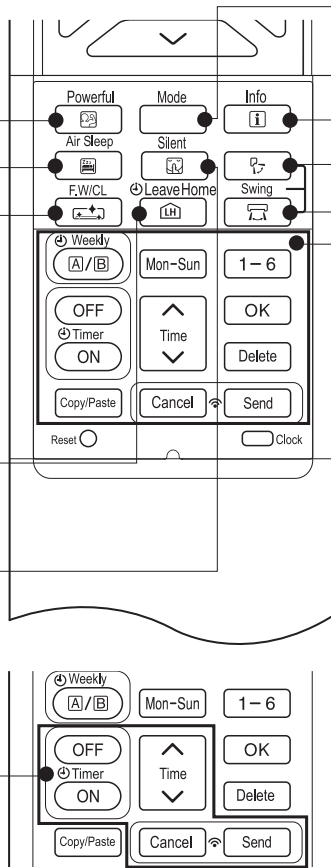

MODE Button

Use this button to select the operating mode. Every time you press this button, the mode will change from (A) (AUTO) → ☀ (HEAT) → 💧 (DEHUMIDIFY) → ❄ (COOL) and → 🌀 (FAN) cyclically.

INFORMATION Button

(▶ p. 49)

AUTO SWING (Vertical) Button

Controls the angle of the horizontal air louver. (▶ p. 30)

AUTO SWING (Horizontal) Button

Controls the angle of the vertical air louver. (▶ p. 30)

WEEKLY TIMER setting Buttons

(▶ p. 43)

	Mode Selector
	Auto
	Heat
	Dehumidify
	Cool
	Fan
	Fan Speed
	Auto Silent
	Low
	Med
	High
	Start / Stop
	Eco

	Fan
	Powerful
	Silent
	Info
	Air sleep
	Auto swing (Vertical)
	Auto swing (Horizontal)
	Leave home
	Frost Wash/Clean
Mon-Sun	Day
1-6	Program no.

	ON / OFF Timer
	Time
	OK
	Delete
	Copy/Paste
	Cancel
	Send
	Clock

Precautions for Use

- Do not place the remote controller in the following places.
 - Under direct sunlight.
 - In vicinity of heater.
- Handle the remote controller carefully. Do not drop it on the floor, and protect it from water.
- Once the outdoor unit stops, it will not restart for about 3 minutes (unless you turn the power switch off and on or unplug the power cord and plug it in again). This is to protect the room air conditioner and does not indicate a failure.
- If you press the Mode selector button during operation, the room air conditioner may stop for about 3 minutes for protection.

VARIOUS FUNCTIONS

Auto Restart Control

- After recovering from power cut, the room air conditioner will automatically restore with operation mode and airflow operation mode and airflow operation set previously.
(This is because operation is not stopped by the remote controller).
Note: 1. If you do not require Auto Restart Control, please contact your local sales agent.
- Auto restart control is not available when the Timer or Sleep Timer is set.

AUTOMATIC OPERATION

The room air conditioner automatically selects the mode, i.e, HEAT or COOL depending on the current room temperature. The selected mode of operation will change when the room temperature varies. However, the mode of operation will not change when indoor unit is connected to multi type outdoor unit.

1 Press the Mode button so that the display indicates the **(A)** (Auto) mode of operation.

- When Auto mode is selected, the room air conditioner automatically selects either HEAT or COOL mode depending on the current room temperature.
- If the mode automatically selected by the unit is not satisfactory, manually change the mode setting (Heat, Dehumidify, Cool or Fan).

2 Set the desired Fan Speed with the **FAN** (Fan Speed) button (the display indicates the setting).

→ **(Auto)** → **(High)** → **(Med)** → **(Low)** → **(Silent)** → **(Auto)**

3 Set the desired room temperature with the TEMPERATURE buttons (the display indicates the setting).
The temperature setting and the actual room temperature may vary depending on conditions.
Temperature range can be set between 60°~90°F(16°~32°C).

START STOP Press the **(I)** (START/STOP) button.
Operation starts with a beep.
Press the button again to stop operation.

- As the settings are stored in the memory of the remote controller, you only have to press the **(I)** (START/STOP) button next time.

Press the **FAN** (Fan Speed) button to select Auto, High, Med, Low or Silent.

HEATING OPERATION

- Use the room air conditioner for heating when the outdoor temperature lies within the range stated in indoor unit operation manual. When the temperature is too warm, the heating operation may not work in order to protect the room air conditioner.
- To maintain the reliability of the room air conditioner, please operate when outdoor temperature is above minimum operating range.

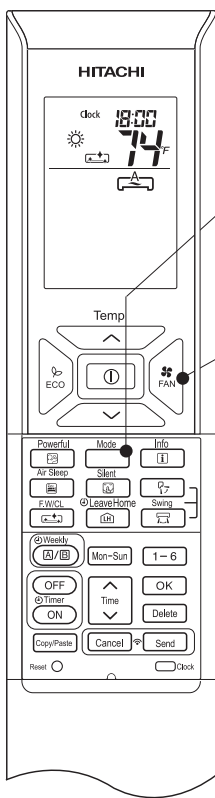

1 Press the Mode button so that the display indicates ☀ (HEAT).

Set the desired FAN SPEED with the (FAN SPEED) button (the display indicates the setting).

```

    graph LR
      A[Auto] --> B[High]
      B --> C[Med]
      C --> D[Low]
      D --> E[Silent]
      E --> A
  
```

2 Set the desired room temperature with the TEMPERATURE buttons (the display indicates the setting).

3 The temperature setting and the actual room temperature may vary depending on conditions.
Temperature range can be set between 60° ~ 90° F (16° ~ 32°C).

START STOP Press the (START/STOP) button. Heating operation starts with a beep. Press the button again to stop operation.

- As the settings are stored in the memory of the remote controller, you only have to press the (START/STOP) button next time.
- During AUTO fan, the fan speed automatically changes as below:
 - When the difference between room temperature and set temperature is large, the fan starts to run at High speed.
 - The fan speed changes to lower fan speed when the room temperature reaches the preset temperature. This is to maintain optimum room temperature condition for heating.

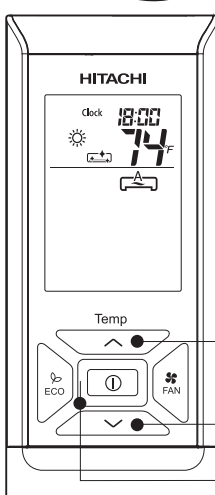

Defrosting



Defrosting will be performed about 5~10 minutes for every 1 hour when frost forms on the heat exchanger of the outdoor unit.
During the defrost operation, the operation LED blinks in a cycle of 2 seconds on and 1 second dim. The maximum time for defrosting is about 20 minutes.
However, if the indoor unit is connected to multi type outdoor unit, the maximum time for defrosting is 15 minutes.
(If the piping length used is longer than usual, frost is likely to form.)

DEHUMIDIFYING OPERATION

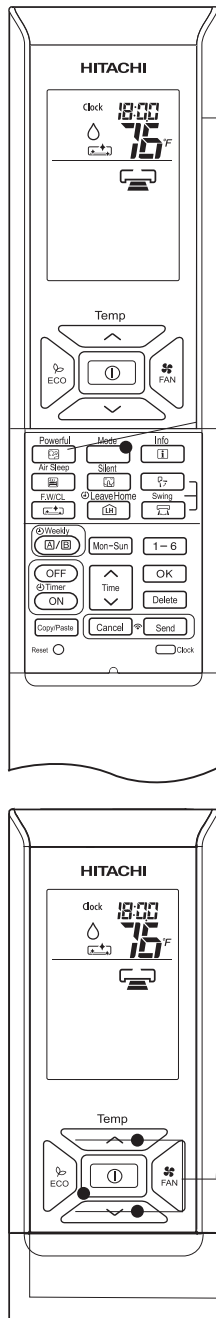
Use the room air conditioner for dehumidifying when the room temperature is over 60°F (16°C).
When it is under 59°F (15°C), the dehumidifying function will not work.



1

Press the Mode button so that the display indicates  (Dehumidify).
The fan speed is set at Low.
Press  (Fan Speed) button to select Silent or Low fan speed.

2

Set the desired room temperature with the ROOM TEMPERATURE setting buttons (the display indicates the setting).



The range of 68° ~ 78°F (20° ~ 26°C) is recommended as the room temperature for dehumidifying.
Temperature range can be set between 60° ~ 90°F (16° ~ 32°C).

START STOP

Press the  (START/STOP) button. Dehumidifying operation starts with a beep. Press the button again to stop operation.

■ As the settings are stored in the memory of the remote controller, you only have to press the  (START/STOP) button next time.

■ Dehumidifying Function

- When the room temperature is higher than the temperature setting: The device will dehumidify the room, reducing the room temperature to the preset level.
When the room temperature is lower than the temperature setting: Dehumidifying will be performed at the temperature setting slightly lower than the current room temperature, regardless of the temperature setting.
- The preset room temperature may not be reached depending on the number of people present in the room or other room conditions.

COOLING OPERATION

Use the room air conditioner for cooling when the outdoor temperature lie within the range stated in indoor unit operation manual. If indoors humidity is very high (80%), some dew may form on the air outlet grille of the indoor unit.

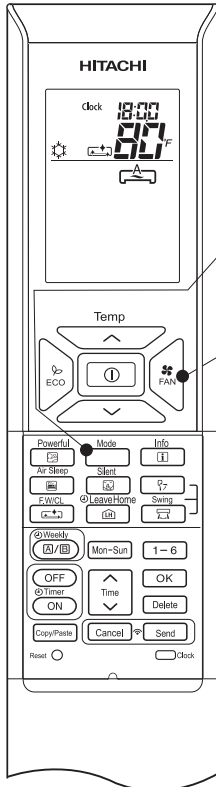

1

Press the Mode button so that the display indicates  (Cool).

2

Set the desired Fan Speed with the  (Fan Speed) button (the display indicates the setting).

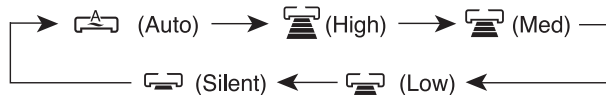



3

Set the desired room temperature with the TEMPERATURE buttons (the display indicates the setting).

The temperature setting and the actual room temperature may vary depending on conditions.

Temperature range can be set between 60° ~ 90°F (16° ~ 32°C).

**START
STOP**

Press the  (START/STOP) button. Cooling operation starts with a beep. Press the button again to stop operation. The cooling function does not start if the temperature setting is higher than the current room temperature (even though the  (OPERATION) lamp lights). The cooling function will start as soon as user set the temperature below the current room temperature.

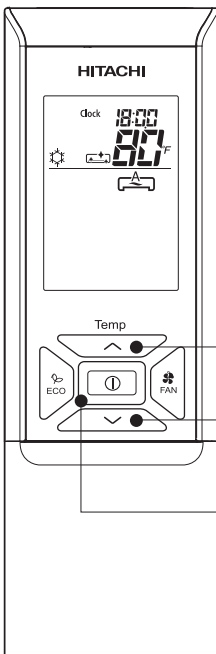



- As the settings are stored in the memory of the remote controller, you only have to press the  (START/STOP) button next time.
- During AUTO fan, the fan speed automatically changes as below:
 - When the difference between room temperature and setting temperature is large, fan starts to run at HI speed.
 - After room temperature reaches the preset temperature, fan speed will be changed to lower speed to obtain optimum room temperature condition for natural healthy cooling.



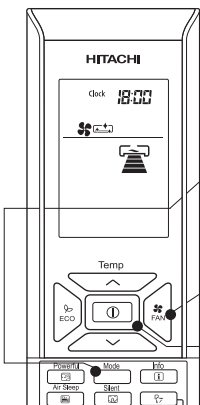

FAN OPERATION

User can use the remote controller simply as an air circulator.



1 Press the Mode selector so that the display indicates  (Fan).

2 Set the desired Fan Speed with the  (Fan Speed) button (the display indicates the setting).



→  (High) →  (Med) →  (Low) →  (Silent)

START STOP Press the  (START/STOP) button. Fan operation starts with a beep. Press the button again to stop operation.



AUTO SWING OPERATION

VERTICAL SWING

To start Vertical Auto Swing

- Press  (AUTO SWING (VERTICAL)) button. The louver swings vertically.
 displays on the LCD.

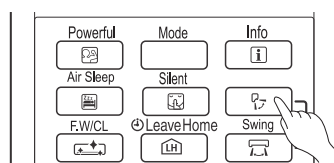

To cancel Vertical Auto Swing

- Press  (AUTO SWING (VERTICAL)) button again. The louver stops at its current position.
 disappears from the LCD.





HORIZONTAL SWING

To start Horizontal Auto Swing

- Press  (AUTO SWING (HORIZONTAL)) button. The louver swings horizontally.
 displays on the LCD.

To cancel Horizontal Auto Swing

- Press  (AUTO SWING (HORIZONTAL)) button again. The louver stops at its current position.
 disappears from the LCD.

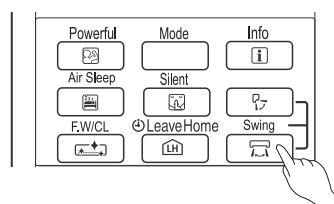

NOTE

- For condition vertical and auto swing set during COOLING and dehumidifying, do not let the louvers swing or in the lower position for a long time. It may lead to dew condensation on the louvers.



POWERFUL OPERATION

- By pressing  (Powerful) button during AUTO, HEATING, DEHUMIDIFYING, COOLING or FAN operation, the air conditioner performs at the maximum power.
- During POWERFUL operation, cooler or warmer air flow blows out from the indoor unit for COOLING or HEATING operation respectively.

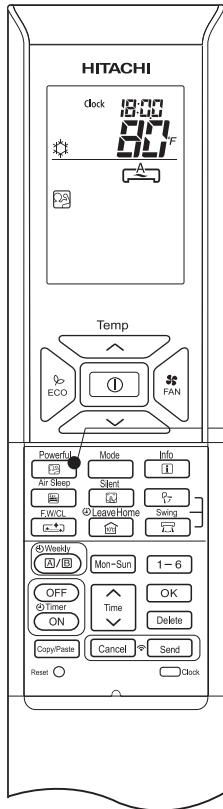

■ To start POWERFUL operation

- Press  (Powerful) button to start powerful operation.

“” displays on the LCD.

POWERFUL operation ends in 20 minutes. Then the system automatically returns to the previous setting.

■ To cancel POWERFUL operation

- Press the  (START/STOP) button. Or

- Press  (Powerful) button again.

POWERFUL operation stops.

“” disappears from the LCD.

NOTE

- When SLEEP mode, ECO mode, SILENT mode or LEAVE HOME mode is selected, POWERFUL operation is cancelled.
- During POWERFUL operation, capacity of the air conditioner will remain the same.
 - if the air conditioner is already running at maximum capacity.
 - just before defrost operation (when the air conditioner is running in HEATING operation).
- After auto restart, POWERFUL operation is cancelled and previous operation shall start.
- For multi model connections, POWERFUL operation may not function depending on operation conditions.

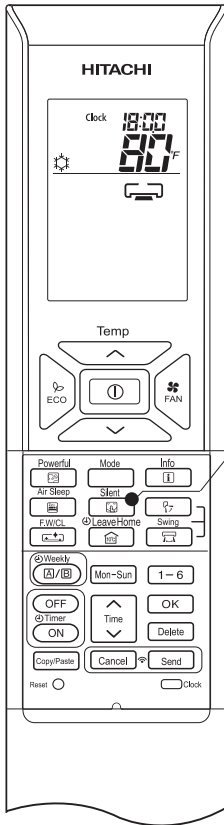

SILENT OPERATION

- By pressing  (Silent) button during AUTO, HEATING, DEHUMIDIFYING, COOLING or FAN operation, the fan speed will change to silent fan speed.







■ To start SILENT operation



1

- Press  (Silent) button during operation.
“” blinks during Silent. Fan speed will be in silent.

■ To cancel SILENT operation

- Press  (START/STOP) button. Or
- Press  (Silent) button again or  (Fan Speed) button.
Fan speed returns to previous fan speed before SILENT operation starts.
SILENT operation stops.
“” stops blinking on the LCD.

NOTE

- When POWERFUL operation is selected, SILENT operation is cancelled. Fan speed returns to previous fan speed before SILENT operation.
- After auto restart, SILENT operation is cancelled. Fan speed returns to previous fan speed before SILENT operation.
- During any operation with fan speed  (Silent), if press  (Silent) button, fan speed does not change.

ECO OPERATION

There are two kinds of ECO OPERATION with sensor or without sensor, depending on models. Please refer to [Names and Functions of each part] in the unit instruction manual to verify if your unit is equipped with a sensor and read the following instruction on ECO Operation accordingly.

■ ECO OPERATION (WITHOUT SENSOR)

ECO operation is an energy saving function by changing set temperature automatically and by limiting the maximum power consumption value.

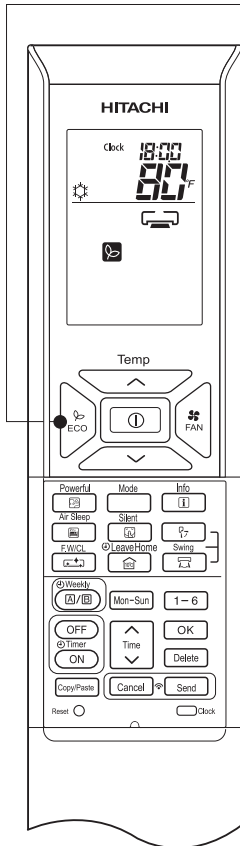

1

- Press  (ECO) button during AUTO, HEATING, DEHUMIDIFYING or COOLING operation.

■ To start ECO operation



- Press  (ECO) button during operation.

“  ” displays on the LCD.

A beep sound is emitted from indoor unit.

Energy saving operation starts by changing the set temperature higher or lower automatically and limiting power consumption. This function may vary based on the connected outdoor unit.

■ To cancel ECO operation

- Press  (START/STOP) button. Or
- Press  (ECO) button again.

“  ” disappears from the LCD.

A beep sound is emitted from indoor unit.

NOTE

- ECO function will not be effective when power consumption is low.
- By pressing (POWERFUL) button, ECO operation is cancelled.
- After auto restart, ECO operation is cancelled and previous operation mode shall resume.
- For multi model connections, energy saving operation shall start only by changing set temperature higher or lower automatically. However, effectiveness of ECO depends on operation conditions.

■ **ECO OPERATION (WITH SENSOR)**

The sensor detects the presence of people in the room. When nobody is detected, the unit automatically starts energy saving operation by shifting the set temperature in two steps.

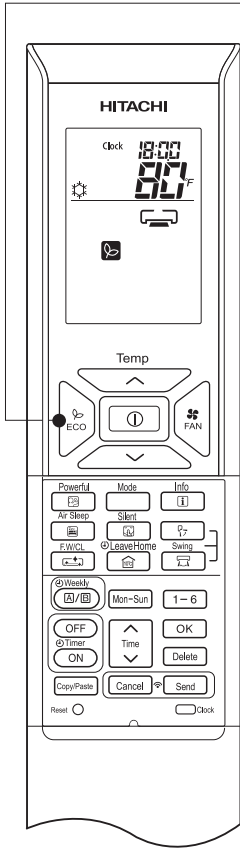

1

- Press (ECO) button to start ECO during AUTO, HEATING, DEHUMIDIFYING or COOLING operation.

■ **To start ECO operation**

- Press (ECO) button during operation.

“ ” displays on the LCD.

A beep sound is emitted from indoor unit.

The sensor starts to detect the presence of people in the room.

■ **To cancel ECO operation**

- Press (START/STOP) button. Or

- Press (ECO) button again.

“ ” disappears from the LCD.

A beep sound is emitted from indoor unit and the (ECO) lamp on the indoor unit turns off.

When the presence of people is not detected for 20 minutes, the set temperature is automatically shifted for energy saving. If nobody is in the room for 60 minutes, the set temperature is shifted further.

Cooling operation [diagram representation for illustrative purpose only]

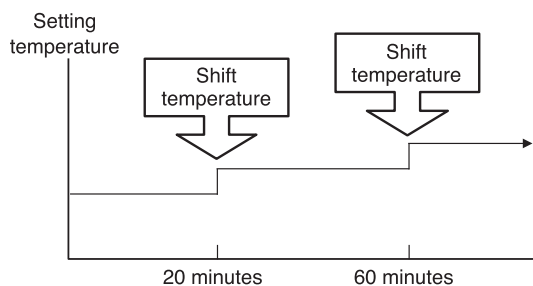

Heating operation [diagram representation for illustrative purpose only]

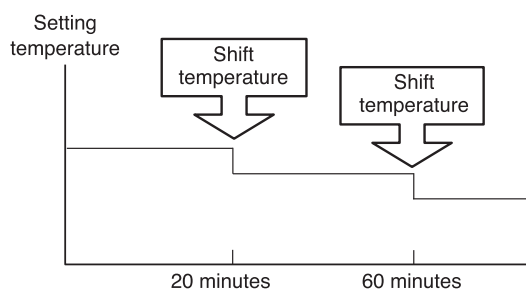

The unit returns to normal operation when the sensor detects human movement.

NOTE

- By pressing (POWERFUL) button, ECO operation is cancelled.
- After auto restart, ECO operation is cancelled and previous operation mode shall start.

LEAVE HOME(LH) OPERATION

Prevent the room temperature from falling too low when no one is at home. The default setting is 50°F (10°C) and the range can be set between 50° ~ 60°F (10° ~16°C).
 This operation is able to operate by "Continuous operation" or "Day timer operation". Please use "Day timer operation" to set the number of days up to 99 days.

Continuous operation

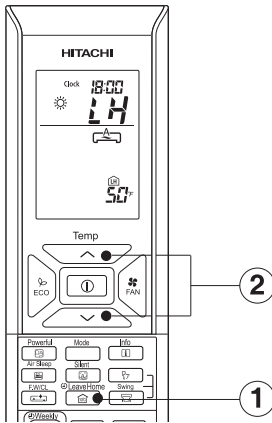

Day timer operation

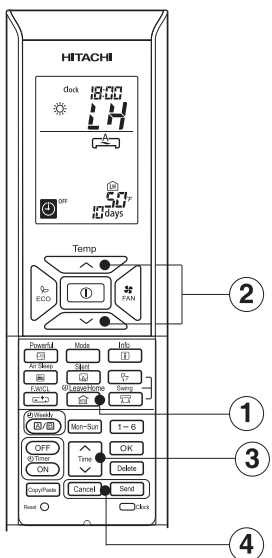



■ To start LEAVE HOME operation

Option 1. Continuous operation.

- 1 Press  (LEAVE HOME) button.



Room temperature is set at 50°F (10°C) and heating operation starts.

- 2 Set the desired room temperature with TEMPERATURE buttons. Temperature range can be set between 50° ~ 60°F (10° ~16°C).
 “☀”, “LH”, “”, “” “SET TEMPERATURE” are displayed on the LCD.

Option 2. Day timer operation.

Press  (LEAVE HOME) button during stop or operation.

Room temperature is set at 50°F (10°C) and heating operation starts.

Set the desired room temperature with TEMPERATURE buttons. Temperature range can be set between 50° ~ 60°F (10° ~16°C).
 “☀”, “LH”, “”, “” “SET TEMPERATURE” are displayed on the LCD.

- 3 Set number of operation days (1 to 99 days).

Press  (Time) button to select number of days.

Number of days blink.

* Press “ (UP)” or “ (DOWN)” to set number of days from 1 day to 99 days.

* Number of day is counted when clock indicates 0:00.

- 4 Press  (Send) button to confirm number of operation days. Display for number of operation days stops blinking.

Press  (Cancel) button to reset number of operation days or to have continuous operation.

NOTE

- After reaching the set number of operation days for Leave Home or by pressing the (Leave Home) button again, the unit operates in previous mode.
- During Leave Home operation, fan speed and horizontal air louver position cannot be changed.
- By pressing (Leave Home) button, implementation of Weekly Timer or Once Timer is cancelled.
- In case of power supply shut down, after autostart, all setting for number of days operation will be reset and unit shall be in continuous operation.
- POWERFUL, SILENT and ECO operations are not applicable during Leave Home operation.
- For multi connection
 - FAN/COOLING/DEHUMIDIFYING and Leave Home cannot operate at the same time. The first-run unit has a priority and other units in different mode will be in standby mode.
 - Heating operation can be used with Leave Home.
 - When two or more rooms are set to operate Leave Home, the temperature set by Leave Home may not be reached. It also depends on outdoor temperature.

FROST WASH OPERATION (For single model connection)

- The dust and dirt adhere to indoor heat exchanger is the cause of the smell. Dust and dirt are being removed by freezing and thawing on the heat exchanger.
- Frost wash function operates when the outdoor temperature is 34° ~ 109°F (1° ~ 43°C) and indoor humidity is 30% to 70%.
- There are two kinds of Frost Wash operation, auto mode and manual mode.

■ Frost Wash (Auto mode)

The process of Frost Wash

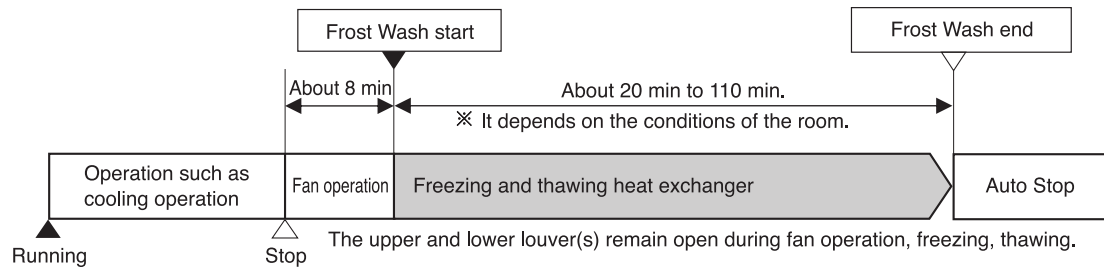

- LED on the indoor unit lights up during Frost Wash operation.
- If user wishes to stop Frost Wash operation, press the ① (START/STOP) button twice.
- When pressing the button such as cooling during Frost Wash operation, Frost Wash operation is discontinued and cooling operation will start after 3 minutes approximately.
- When Frost Wash is stopped during Frost Wash operation, the unit automatically restarts Frost Wash Operation during room air conditioner is in standby mode.
- In order to protect the product, Frost Wash function cannot be carried out again for about 60 minutes after Frost Wash operation is completed.

Frost Wash auto start conditions

Accumulated operating hours of the air conditioner have exceeded 42 hours
 +
 Air conditioner is operated for more than 30 minutes and stops, such as cooling operation
 +
 Human sensor detects human presence in the room for 15 minutes and over 4 times; or not in room for 15 minutes

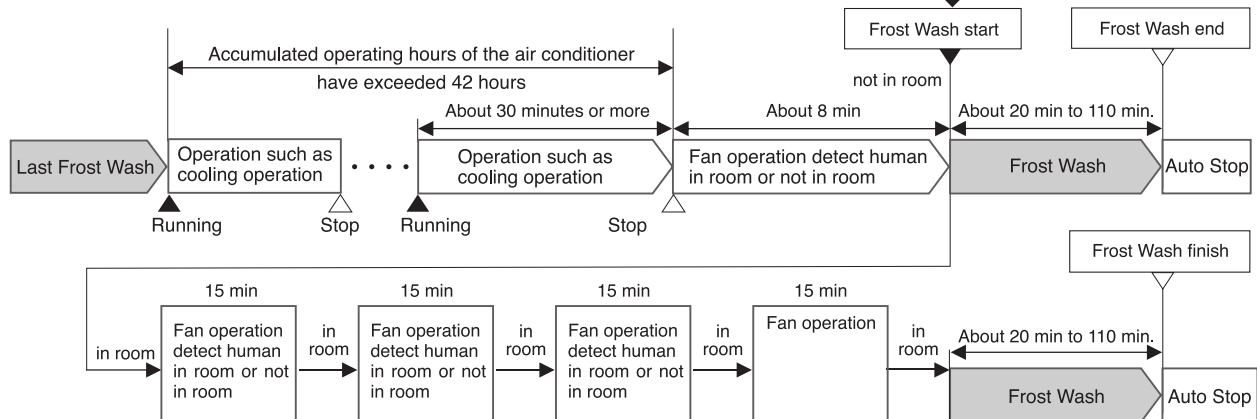



- When the outdoor temperature or indoor humidity are not suitable for Frost Wash operation, only fan operation is carried out, Frost Wash operation will be done when room air conditioner is in standby mode.
- Sometimes the heat exchanger may not freeze depending on the conditions of the room.
- When the ON timer reaches the set time during Frost Wash operation, it will stop the Frost Wash operation and start the operation of setting mode.
- If the interval of the Off to On timer is less than 2 hours, Frost Wash operation may not be completed. In that case, it will restart Frost Wash operation at the next operation stop.
To return to normal Frost Wash (Auto mode) interval (42 hours), please stop operation of air conditioner and operate Frost Wash (Auto mode) or Frost Wash (Manual mode).
- When the Frost Wash operation has not been operated in last 84 hours, Frost Wash kicks in automatically after halting the operation even if a human sensor detects a person in the room.

FROST WASH OPERATION (For single model connection)

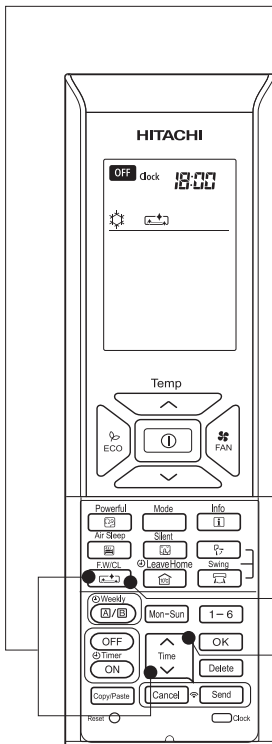
■ To disable Frost Wash (Auto mode)





1

Press  (Time) button and  (Frost Wash/Clean) button on the same, Frost Wash (Auto mode) is canceled. "

■ To enable Frost Wash (Auto mode)

2

Press and hold  (Time) button and  (Frost Wash/Clean) button on the same, Frost Wash (Auto mode) is set. "

- If Frost Wash function is not being used for a long period, it may not be possible to completely remove the dust and dirt adhering to indoor heat exchanger. This will cause odour. Hence, kindly operate Frost Wash frequently by using the remote controller.

■ The screen of the remote control

- At Frost Wash (Auto) enabled "
- At Frost Wash (Auto) disabled "



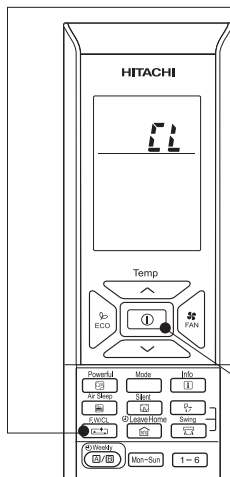

■ Frost Wash (Manual mode)

When room air conditioner is in standby condition, press  (Frost Wash/Clean) button to start manual frost wash.





■ How to start and cancel Frost Wash (Manual mode)

1

- Press  (Frost Wash/Clean). "
- After one hour, "
- In order to protect the product, Frost Wash function cannot be carried out again for about 60 minutes after the Frost Wash operation is completed.
- Recommended time for Frost Wash operation will be indicated by "

2

- Press  (START/STOP) button, the operation will stop. "

Precautions for Use

- Do not open windows or doors during frost wash operation. Water will condense on the air louver and drips down occasionally. This may wet your furniture.
- Do not open or remove the front panel during Frost Wash operation. It may cause injury or malfunction.
- Frost Wash operation does not wash away all dust and dirt.
- Hissing, fizzy or squeaking noise may be produced during Frost Wash operation.
- If the room air conditioner is continuously running, Frost Wash function is not effective.
- During Frost Wash operation, if there is power loss and when the power supply is restored, Frost Wash function will not restart.
- After turning on the power supply, please wait for a while before operating Frost Wash operation.



OUTDOOR FROST WASH OPERATION (For single model connection)

- Dust and dirt are being removed by freezing and thawing on the heat exchanger. Outdoor Frost Wash Function operates when the outdoor temperature is between 41° ~ 77°F (5°~25°C) and indoor room temperature 41°~77°F(5°~25°C).
- Outdoor Frost Wash operation will operate automatically.

Outdoor Frost Wash (Auto mode)

Outdoor Frost Wash Process

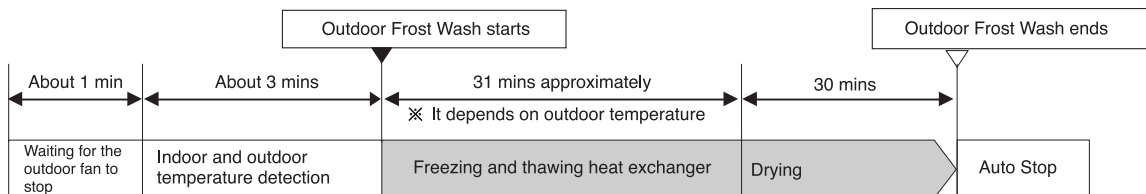

The upper and lower louver(s) remain open during freezing and thawing.

- Frost Wash LED on the indoor unit lights up during Outdoor Frost Wash operation.
- If user wishes to stop Frost Wash operation, press the ① (START/STOP) button.
- After operating for about 10 mins or more and stopping (excluding ventilation operation, the fan outdoor unit rotates in reverse direction for about 3 mins each time to remove dust from the heat exchanger).
- During Outdoor Frost Wash, the entire of heat exchanger frost. After that, it will thaw to wash away dirt from the heat exchanger.
- Do not bring hair or tiny rope too close to the outdoor unit when the fan of outdoor unit is rotating in reverse direction.

Outdoor Frost Wash auto start conditions

60 days after 1 Outdoor Frost Wash Operation



Indoor temperature and outdoor temperature satisfy the condition

- If the conditions are not met, Outdoor Frost Wash will restart on the next day at the same time.
- During Outdoor Frost Wash process, if user stops or cancels then auto Outdoor Frost Wash will start after 60 days has passed.
- If timing for auto Indoor Frost Wash and Outdoor Frost wash are overlapped, Indoor Frost Wash will be executed first.
- Depending on the environment, the heat exchanger may not freeze.

CLEAN (ONE TOUCH CLEAN) OPERATION (For multi model connections)

Use this function to dry the heat exchanger of the indoor unit to prevent formation of mildew.

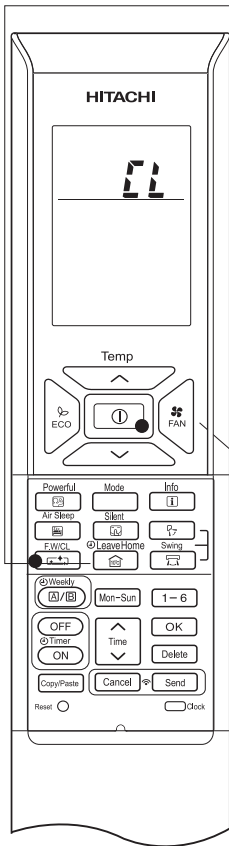

■ To start CLEAN operation

- 1 ● Press  (Frost Wash/Clean) button when unit is OFF.
Total time taken for One Touch Clean operation when the room air conditioner is in standby condition. During this operation, FAN operation shall operate.
During one touch clean, operation LED is blinking.
“11” is displayed on the LCD.

■ To cancel CLEAN operation

- 2 ● Press  (START/STOP) button

NOTE

- When Clean operation completes, room air conditioner enters standby condition automatically.
- If Weekly Timer or Once Timer is set, these timers must be cancelled before operating Clean operation.
- For multi model connections, when pressing  (Frost Wash/Clean) button, only fan operation is available
- For multi connections, when one room operates CLEAN operation first, other rooms can operate COOLING, DEHUMIDIFYING or FAN operation. However, when other rooms need to operate HEATING operation, air conditioner will be in STANDBY condition. After Clean operation finished, HEATING operation will start.



ONCE TIMER (ON/OFF TIMER) OPERATION

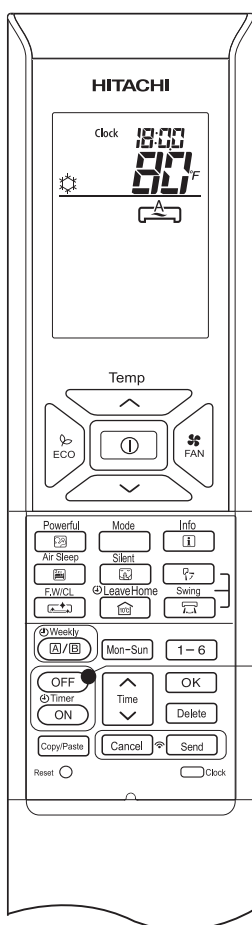

OFF TIMER

This remote controller can be used to turn off the room air conditioner at preset time.

1. Press (OFF-Timer) button. and **0:00** blink on the display.
2. Set the "turn-off time" with (Time) button.

3. After setting, point the remote controller towards the indoor and press (Send) button.

and "set time" lights up instead of blinking.

A beep sound emitted from indoor unit and the (TIMER) LED on the indoor unit lights up.

ON TIMER

This remote controller can be used to turn on the room air conditioner at preset time.

1. Press (ON-Timer) button. and **6:00** blink on the display.

2. Set the "turn-on time" with (Time) button.

3. After setting, point the remote controller towards the indoor and press (Send) button.

and "set time" light up instead of blinking.

A beep sound emitted from indoor unit and the (TIMER) LED on the indoor unit lights up.

ON/OFF TIMER

- The room air conditioner will turn on or turn off at the designated time.
- The room air conditioner will turn on or turn off based on the first setting.
- The arrow mark appears on the display to indicate the sequence of switching operations.

1. Press (OFF-Timer) button so that and **0:00** blink on the display.

2. Set the "turn-off" time with (Time) button. After setting, point the remote controller towards the indoor and press (Send) button.

3. Press (ON-Timer) button so that and set "turn-off" time light up.

The and **6:00** blink.

4. Set the "turn-on" time with (Time) button.

5. After setting, point the remote controller towards the indoor and press (Send) button

and set "turn-on" time light up instead of blinking.

A beep sound emitted from indoor unit and the (TIMER) LED on the indoor unit lights up.

- The timer may be used in three ways: OFF-timer, ON-timer and ON/OFF (OFF/ON)-timer.

■ To cancel Reservation

- Point the signal window of the remote controller towards the indoor unit and press (Cancel) button. and "ON or OFF set time" goes out with a beep and the (TIMER) LED on the indoor unit turns off.

NOTE

- User can set only one of the OFF-timer, ON-timer or ON/OFF-timer.
- If weekly timer is already set, after that if user sets Once Timer, Once Timer is prioritized.







AIR SLEEP OPERATION

With motion sensor, the room air conditioner detects movements, its location and temperature around people to control set temperature and control fan speed to provide comfortable and energy saving operation as well as to achieve comfortable sleep environment.

To start Air Sleep operation

1

Press the  (Air Sleep) button during Cooling operation.

- “”, “” and “” are displayed on the remote controller display.
- During Air Sleep operation, fan speed changes to Low.
- A beep sound emitted from the room air conditioner after Air Sleep signal is sent.

Adjusting Room Temperature

2

- Select the desired temperature with ROOM TEMPERATURE setting button (the display indicates the setting).
- The temperature range from 77° ~ 82°F (25° ~ 28°C) is recommended as the room temperature for comfortable sleep.

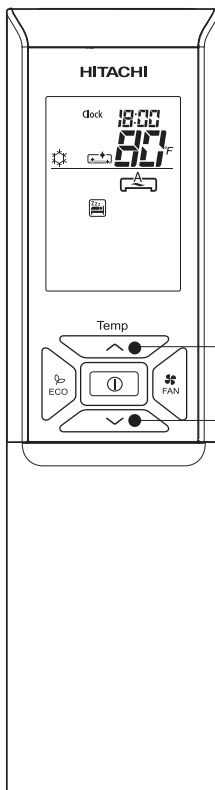
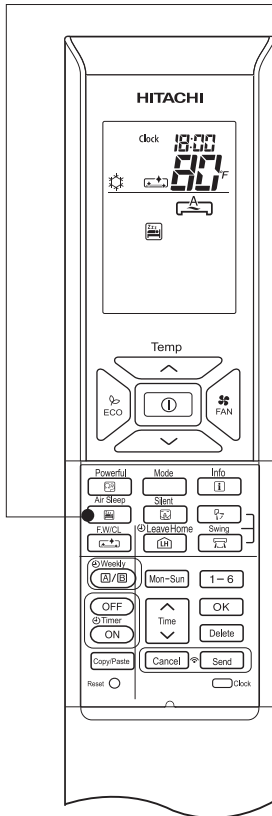



AIR SLEEP OPERATION

■ To cancel Air Sleep operation

Press (START/STOP) button.

- Room air conditioner turns off.

Press (Air Sleep) button.

- Pressing (Air Sleep) button again until “” disappears from the remote controller display.

Press button.

- Pressing (Powerful) button until “” disappears and “” appears on remote controller display.

Press button.

- Pressing (Mode) button again until “” disappears from the remote controller display. Mode appears on remote controller display as per user's selection.

NOTE

- With the motion sensor, the room air conditioner can monitor human movement. If no human movement is detected, then the temperature will be increased automatically 1°F (0.5°C) and the unit continues running for 1 hour. Fan speed changes to SILENT.
- If the condition of activity in the room is stable, the unit continues running with the temperature increases another 1°F(0.5°C).
- If the room temperature has increased, the fan speed changes to LOW automatically.
- If there is only small activity is detected, the temperature will decrease by 1°F (0.5°C).
- Locate position of human & surrounding for air blow operation direction.
- If vigorous human activity is detected, the temperature and fan speed return to previous setting.

WEEKLY TIMER OPERATION

- User can select Mode A or Mode B. For each mode, user can set up to 6 programs perday. In total, maximum of 42 programs can be set for a week for each mode.
- If date and clock are not set, the timer setting for Weekly Timer cannot be set.
- If date and clock are not set correctly, Weekly Timer cannot be operated correctly.
- Setting for calendar and clock shall be set first before operating Weekly Timer.

Step 1 : Set the schedule setting on the remote controller. Point the remote controller to the indoor unit to send the signal of Weekly Timer.

Step 2: Select Mode A or Mode B to enable or disable Weekly Timer..

Step 3: Copy and cancel the schedule setting.

Step 1 : Set the setting schedule on the remote controller. Point the remote controller to the indoor to send the signal of Weekly Timer.

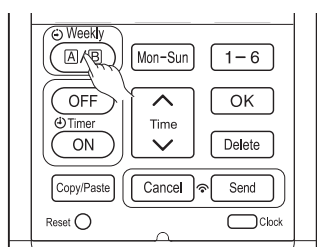

How to set a WEEKLY TIMER.

1. Select Mode A or Mode B

Press (Weekly) button. WEEKLY lights up. **A** and blink on the display. (Mode A is selected).

Press (Weekly) button again, **B** and blink on the display. (Mode B is selected).

- If no setting has been set by user, ON/OFF, , appear.
- If setting has been set by user, ON/OFF, , will not appear.

2. Set a program

Press (Weekly) button for about 3 seconds. User can change mode on the remote controller.

, day: Mon, program no. : 1, ON/OFF, setting time and setting temperature blink on the display.

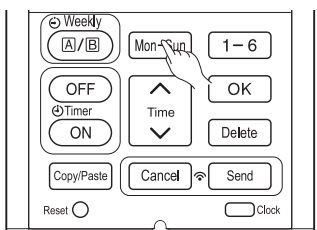

3. Select the desired day of the week

Press (DAY) button.

The day changes from Mon → Tue → Wed → Thu → Fri → Sat → Sun → Mon, Tue, Wed, Thu, Fri, Sat, Sun [Full days] → Mon, Tue, Wed, Thu, Fri [weekday] → Sat, Sun [weekend] → Mon → Tue

Select [Full days] for daily setting.

Select [weekday] for Monday to Friday setting.

Select [weekend] for Saturday and Sunday setting.

- After setting has been set, it is easier for user to check and modify at the same time.

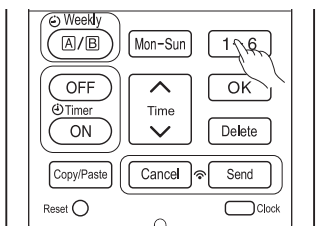

4. Press button to select a program number.

The number changes from 1 → 2 → 3 → 4 → 5 → 6 → 1 → 2

- If program number has been set, follow above in order to make changes.

WEEKLY TIMER OPERATION

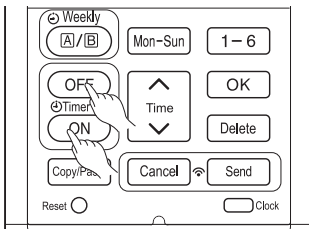

5

5. Press (ON-OFF TIMER) button to select ON TIMER or OFF TIMER setting.

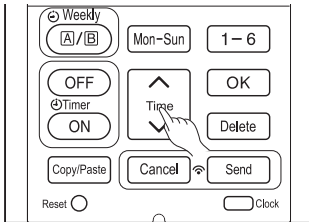

6

6. Press (Time) button to set time setting.

7. Press (TEMP ^ or v) button to set temperature setting.

8. Press (OK) button. The setting is set. Day, program number, ON setting and setting temperature display on the remote controller. continuously blinks. If setting is not completed, setting will not be saved in memory.

To set another Weekly Timer, press buttons. Repeat the steps from 3 to 8.

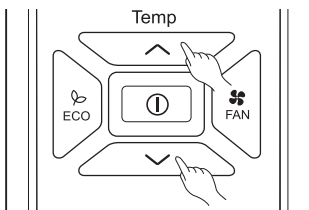

7

9. After all the setting have been set, press (Send) button while pointing the remote controller towards the indoor unit for about 3 seconds. Timer LED on the indoor unit blinks rapidly.

After beep sound emitted from indoor unit, Timer LED lights up.

Please ensure that the Timer LED lights up.

This indicates that the setting has been saved in the indoor unit and Timer setting has been completed.

The setting contents appears on the remote controller display.

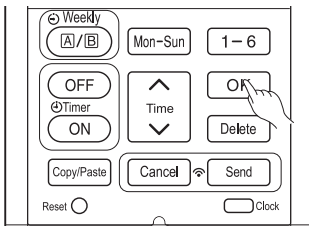

8

- If Timer LED on the indoor unit does not light up, press (Send) button while pointing the remote controller towards the indoor unit for about 3 seconds.

- **CAUTION !** Do not press (Cancel) button during Weekly Timer operation because this will result in all setting contents to be lost.

- The setting contents will not stored in the indoor unit until (Send) button has been pressed.

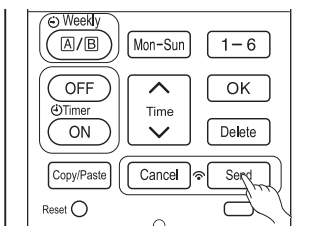

9

NOTE

- Up to 6 programs can be set per day. Setting ON TIMER or OFF TIMER for each program number can be at random. When pressing (Send) button, the set ON TIMER or OFF TIMER for each program number will automatically arranged so that program number 1 shall have the earliest time and program number 6 shall have the latest time. If the setting time is the same, Priority will be given to the latest reservation contents.
- **CAUTION !** If the remote controller is left idle and (Send) button is not pressed within 3 minutes after setting have been made, all current setting will be lost.

WEEKLY TIMER OPERATION

Step 2: Select Mode A or Mode B and enable or disable WEEKLY TIMER.

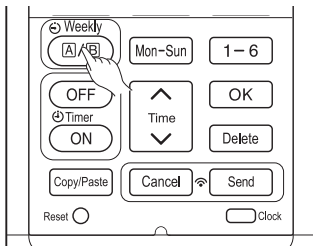

1

■ How to select Mode A or Mode B of WEEKLY TIMER setting.

1. Press (Weekly) button. **A** and blink on the display. (Normally Mode A will blink first).

2

2. Press (Weekly) button again. **B** and blink on the display.

3. Select Mode A or Mode B. Press (Send) button while pointing the remote controller towards the indoor unit for about 3 seconds. Timer LED on the indoor unit blinks rapidly.

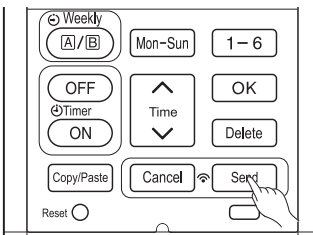

3

After beep sound emitted from indoor unit, Timer LED will light up.

Please ensure that the Timer LED lights up.

This indicates that Mode A or Mode B selection and active WEEKLY TIMER have been confirmed.

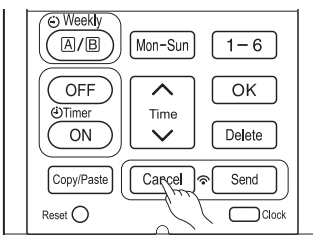

1

■ Setting non-active WEEKLY TIMER .

1. Point the remote controller towards the indoor unit and press (Cancel) button.
Beep sound is emitted from the indoor unit and Timer LED will turn off. Setting indication on remote display also disappears. This indicates that Weekly Timer has been disabled.

- To enable the setting of WEEKLY TIMER , repeat the steps for "How to select Mode A or Mode B of WEEKLY TIMER setting".

NOTE

- When user sets Once timer while Weekly Timer has been set earlier, Weekly Timer will be interrupted. After Once Timer operation is completed, Weekly Timer will resume its operation.
- When ONCE TIMER is cancelled, operation of WEEKLY TIMER is also cancelled. Therefore, Weekly Timer must be set again if user wishes to continue with Weekly Timer operation.
- After auto restart, WEEKLY TIMER operation is cancelled. Therefore, Weekly Timer must be set again if user wishes to continue with Weekly Timer operation.

Step 3: Copy and cancel the schedule setting.

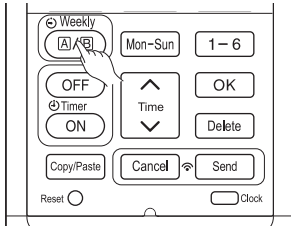

1

■ How to copy and paste.

Editing the schedule setting is easy by copying data from one day to another day.

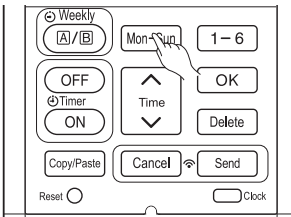

2

1. Press (Weekly) button to select Mode A or Mode B.

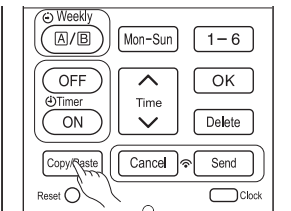

3

2. Press (Weekly) button for about 3 seconds to start editing the schedule setting.

3. Press (DAY) button to select a day of the week to copy.

4. Press (Copy/Paste) button. Then "PASTE" blinks on the display.

* Press (Cancel) button to cancel the COPY mode. Normal setting mode is enabled.

5. Press (DAY) button to select a day of the week to paste.

6. Press (Copy/Paste) button one more time to paste. only blinks on the display.

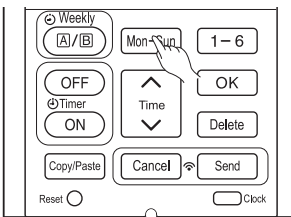

4

7. To continue copying to other days, press or or or



Then start from step 3.

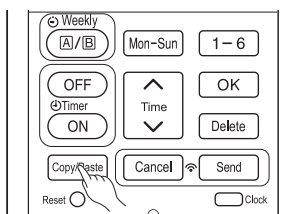

5

8. After copy and paste completed, press (Send) button while pointing the remote controller towards the indoor unit for about 3 seconds. Timer LED on the indoor unit blinks rapidly.

After beep sound emitted from indoor unit, Timer LED lights up.

Please ensure that the Timer LED lights up.

If Timer LED does not light up, Press (Send) button again.

- Setting information will not be updated (Send) button is not pressed.

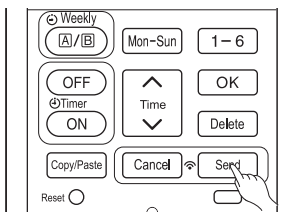

6

NOTE

- If there is no setting information, copying data from one day to another day cannot be done.

WEEKLY TIMER OPERATION

Step 3: Copy and cancel the schedule setting.

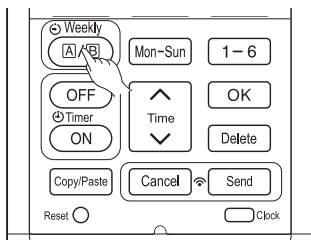

1

2

■ How to delete Weekly Timer setting.

[Delete setting of one program]

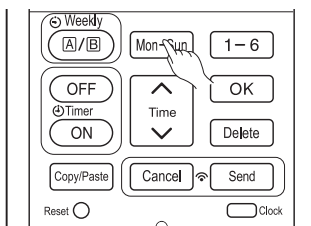

3

4

1. Press (Weekly) button to select Mode A or Mode B.

2. Press (Weekly) button for 3 seconds to start editing the setting.

3. Press (DAY) button to select a day of the week to edit.

4. Press to select program number. Selected program number will blink.

5. Press (Delete) button. Setting of selected program number is deleted.

6. After deleting, press (Send) button while pointing the remote controller towards the indoor unit for about 3 seconds. Timer LED on the indoor unit blinks rapidly.

After beep sound emitted from indoor unit, Timer LED lights up.

Please ensure that the Timer LED lights up.

● Setting will not change if (Send) button is not pressed.

WEEKLY TIMER OPERATION

Step 3: Copy and cancel the schedule setting.

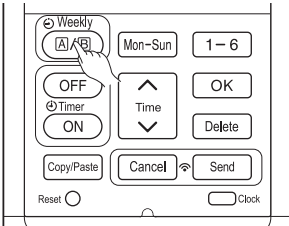

1
2

[Delete setting of one day]

1. Press **(Weekly)** (Weekly) button to select Mode A or Mode B.
2. Press **(Weekly)** (Weekly) button for 3 seconds to start editing the schedule setting.

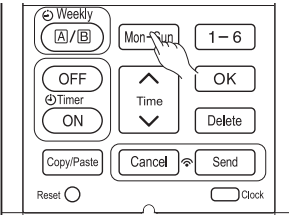

3

3. Press **Mon-Sun** (DAY) button to select a day of the week to edit.
4. Press **Delete** (Delete) button for about 10 seconds. Setting for all program numbers will be deleted.

- If press for a short time, setting for one program number will be deleted.

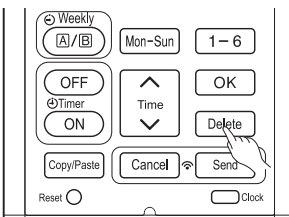

4

5. After deleting, press **Send** (Send) button while pointing the remote controller towards the indoor unit for about 3 seconds. Timer LED on the indoor unit blinks rapidly. After beep sound emitted from indoor unit, Timer LED lights up.

Please ensure that the Timer LED lights up.

- Setting will not change if **Send** (Send) button is not pressed.

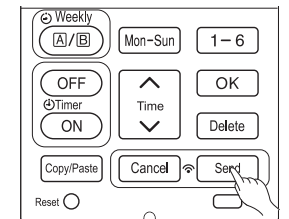

5

[Delete Mode A or Mode B]

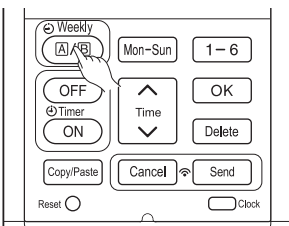

1

1. Press **(Weekly)** (Weekly) button to select Mode A or Mode B.
2. Point the remote controller towards the indoor unit and press **Delete** (Delete) button for about 10 seconds while Mode A or Mode B display blinks.

After beep sound emitted from indoor unit, setting for Mode A or Mode B will disappear.

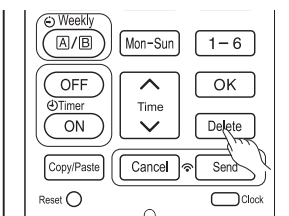



2

NOTE

- If all setting in the remote controller were deleted and pressed **SEND** (SEND) button, no signal will be transmitted to indoor unit. Timer LED will remain off and no changes will be done to the setting saved in the indoor unit.



INFO FUNCTION

- By pressing  (Info) button, temperature around remote controller and monthly power consumption are displayed on the remote controller.
- After changing the batteries, point the remote controller towards the indoor unit and press  (Info) button. Current date and clock will be transmitted from indoor unit.
- In order to receive information from the indoor unit, the distance between remote controller and receiver from the indoor unit should be within 7ft (2m).

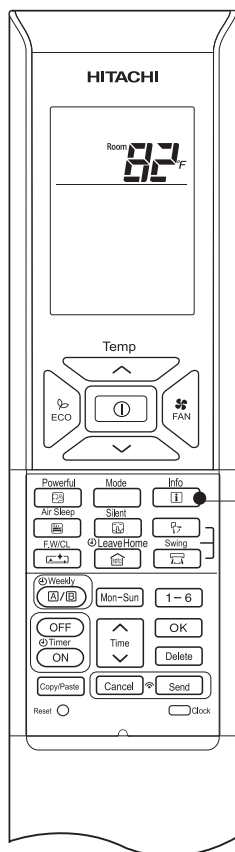

■ To check temperature around remote controller

1

Press  (Info) button.

Temperature displays for 10 seconds.

■ To check monthly power consumption

Direct the remote controller towards the receiver of indoor unit (within 7ft (2m) in front of indoor unit) and press  (Info) button. Wait for 2 seconds for signal transmission.

While temperature around remote controller is displayed, press  (Info) button repeatedly. The display will show as below:

this month power consumption amount for heating → last month power consumption amount for heating → this month power consumption amount for cooling → last month power consumption amount for cooling → temperature around remote controller → this month power consumption amount for heating cyclically.

- If indication is not appeared, bring remote controller closer to the receiver of the indoor unit.
- Indicated value shall be regarded as a reference only.



■ Current calendar and clock can be retrieved from indoor unit

Point the remote controller towards the receiver of indoor unit (within 7ft (2m) in front of indoor unit) and press  (Info) button. Wait for 2 seconds for signal transmission.

Once received the current date and clock, check whether the information is correct or not by pressing  Clock (Clock) button.

- If there is no power supply to indoor unit or calendar and clock have not been set, INFO function cannot be used for sending or receiving information.

NOTE

- In case failure occurs to the room air conditioner, by pressing  (Info) button, an error code will be displayed.
Point the remote controller towards the receiver of indoor unit (within 7ft (2m) in front of indoor unit) and press  (Info) button. Wait for 2 seconds for signal transmission.
An error code will be displayed.
Call service center and inform the error code.
- Information of "Monthly power consumption" is not available for 6 rooms multi system.
- Info Function to check monthly power consumption.
During installation, in case of power failure or breaker ON / OFF, ensure to set the date and clock for each indoor unit (unit in standby mode or auto restart), for single or multi connection, by pressing  (START / STOP) button.
If this procedure is not carried out successfully, monthly power consumption amount will not be displayed on the remote controller.

OPERATION MODE LOCK

The remote controller can be set to fix the HEATING mode (including FAN), COOLING mode (including FAN) and DEHUMIDIFYING mode (including FAN) operations.

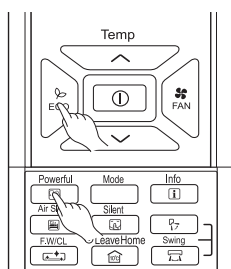

Method to lock HEATING mode (including FAN) operation.

Press (ECO) and (Powerful) buttons simultaneously for about 5 seconds when the remote controller is OFF.

“”, “” and “” will be displayed for about 10 seconds. Later, “” and “” will remain.

This indicates that HEATING mode operation is locked.

When pressing (Mode) button, “” or “” will be displayed.

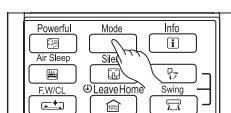

Method to unlock HEATING mode (including FAN) operation.

Press (ECO) and (Powerful) buttons simultaneously for about 5 seconds when the remote controller is OFF.

All operation mode symbols will appear on the display for about 10 seconds. After that, operation mode symbol before cancellation will be displayed.

This indicates that HEATING mode operation is unlocked.

Method to lock COOLING and DEHUMIDIFYING modes (including FAN) operations.

Press (ECO) and (Silent) buttons simultaneously for about 5 seconds when the remote controller is OFF.

“”, “”, “” and “” will be displayed for about 10 seconds. Later, “” and “” will remain.

This indicates that COOLING and DEHUMIDIFYING mode operation is locked.

When pressing (Mode) button, “”, “” or “” will be displayed.

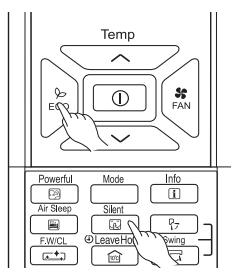

Method to unlock COOLING and DEHUMIDIFYING modes (including FAN) operations.

Press (ECO) and (Silent) buttons simultaneously for about 5 seconds when the remote controller is OFF.

All operation mode symbols will appear on the display for about 10 seconds. After that, operation mode symbol before cancellation will be displayed.

This indicates that COOLING and DEHUMIDIFYING modes operation is unlocked.

NOTE

- Operation Mode Lock function will not be enabled if Timer setting is in use. Timer setting should be disabled first. Then, Operation Mode Lock function can be enabled.
- HEATING, COOLING and DEHUMIDIFYING mode (including FAN) operations can be unlocked by pressing the (Reset) button. However, by pressing the (Reset) button, all the information saved in the remote controller will disappear. You may need to set the necessary information again.
- For multi connections, unit and mode which is set to lock HEATING and switched on first shall have higher priority. Other units which are chosen to operate at different modes shall be in STANDBY until either the first unit operation is switched off or the mode is selected to be same as the first unit.

CONSTRUCTION AND DIMENSIONAL DIAGRAM

INDOOR UNIT

MODEL RAS-PH18PHLAE, RAS-PH24PHLAE

Unit: Inch (mm)

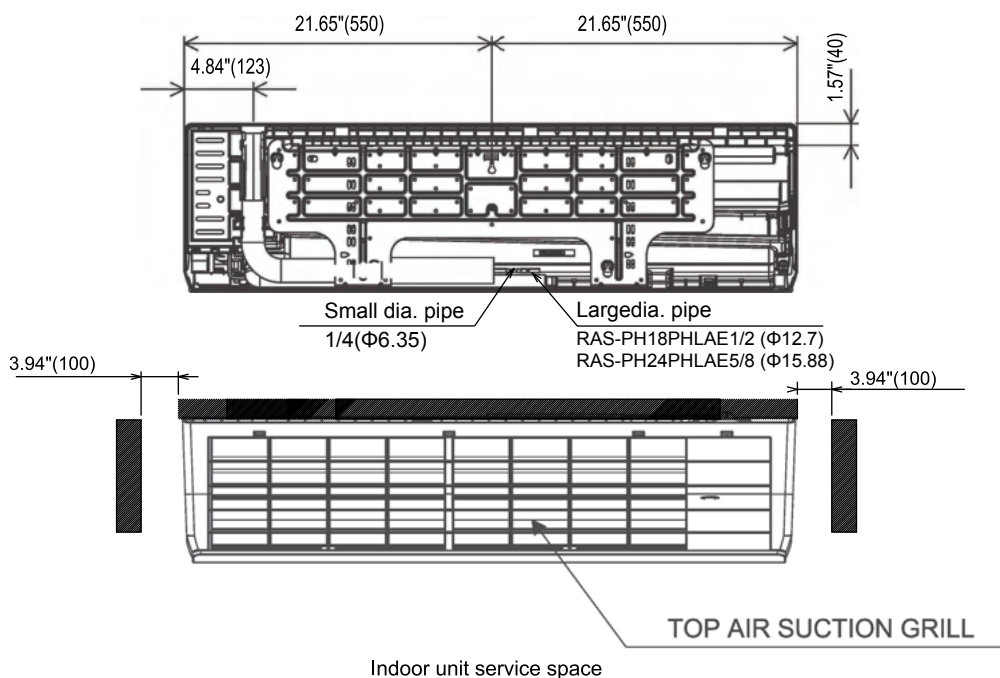
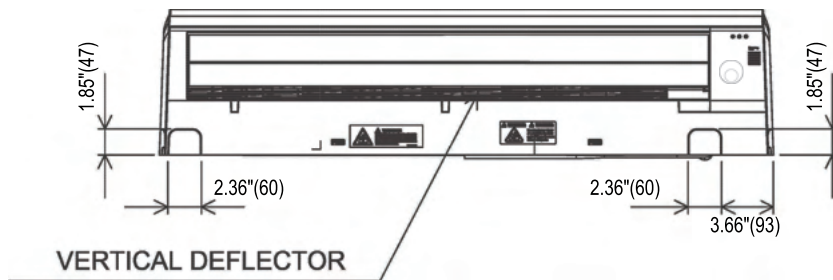
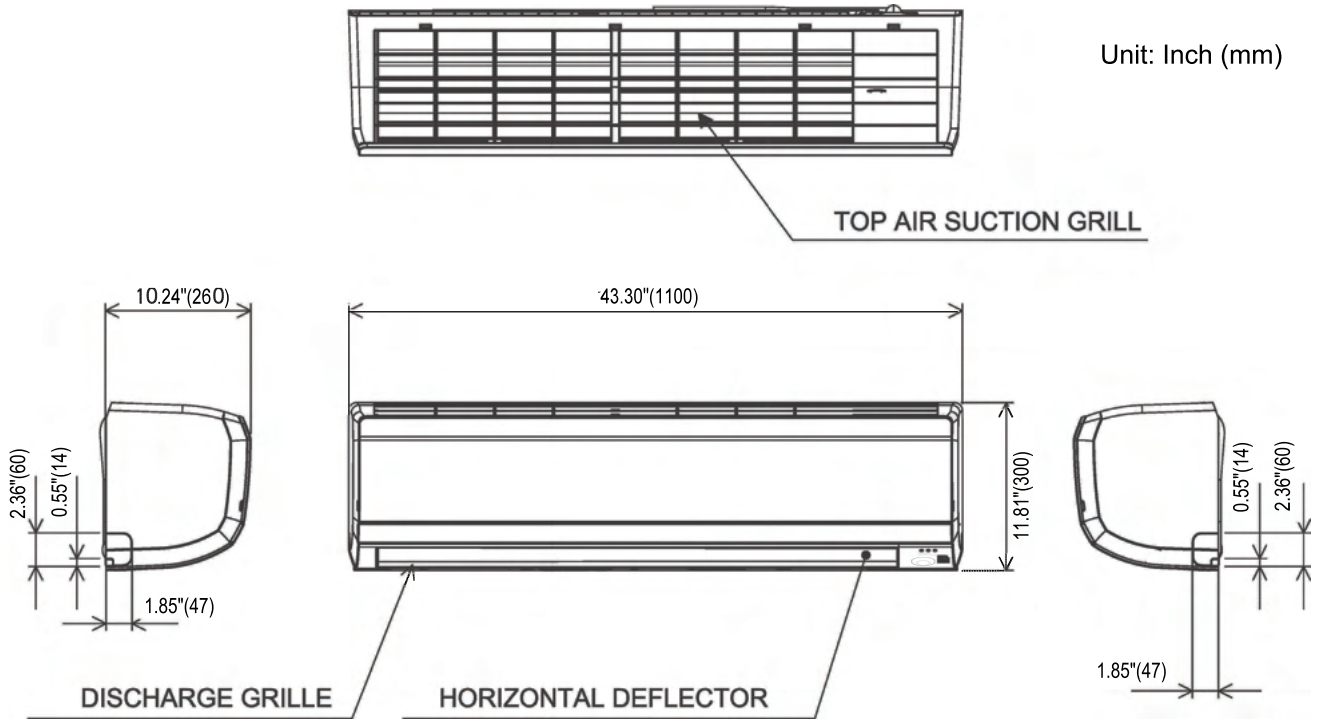

CONSTRUCTION AND DIMENSIONAL DIAGRAM FOR OUTDOOR

Unit: Inch (mm)

OUTDOOR UNIT

MODEL : RAC-PH18WHLAE, RAC-PH24WHLAE

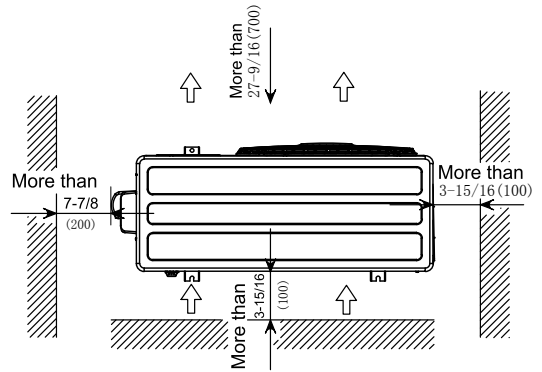
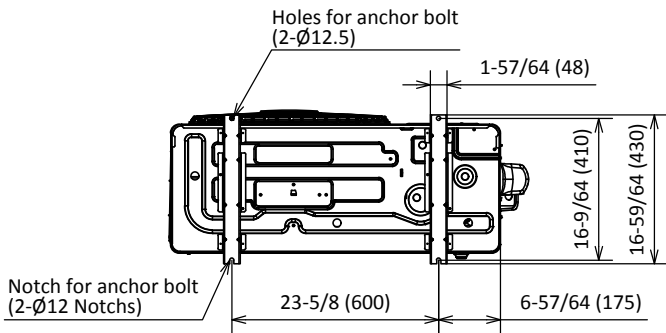
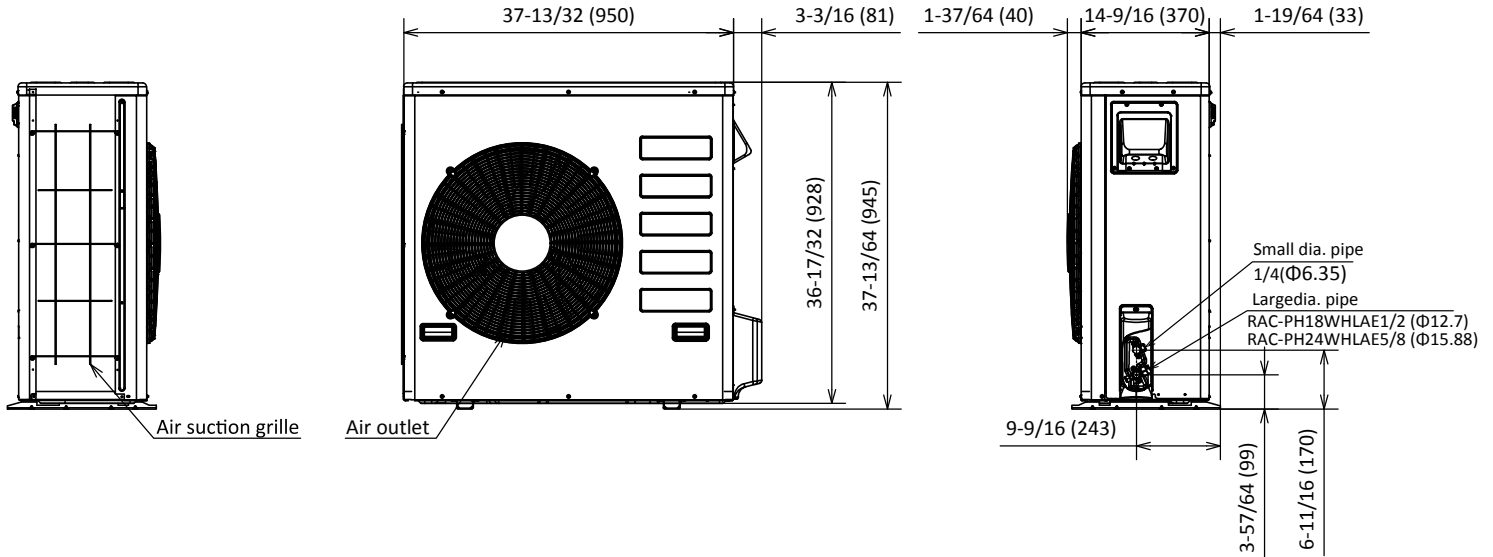

Service space

MAIN PARTS COMPONENT

THERMOSTAT (Room Temperature Thermistor)

Thermostat Specifications

MODEL			RAS-PH18PHLAE, RAS-PH24PHLAE	
THERMOSTAT MODEL			IC	
OPERATION MODE			COOL	HEAT
TEMPERATURE °C (°F)	INDICATION 16	ON	15.6 (60.1)	20.0 (68.0)
		OFF	15.3 (59.5)	20.7 (69.3)
	INDICATION 24	ON	23.6 (74.5)	28.0 (82.4)
		OFF	23.3 (73.9)	28.7 (83.7)
	INDICATION 32	ON	31.6 (88.9)	36.0 (96.8)
		OFF	31.3 (88.3)	36.7 (98.1)

INDOOR FAN MOTOR

Fan Motor Specifications

MODEL	RAS-PH18PHLAE, RAS-PH24PHLAE
POWER SOURCE	DC: 280V
OUTPUT	38W
CONNECTION	<p>DC 280V ○ RED 0V ○ BLK DC 15V ○ WHT 0 ~ 6V ○ YEL FG ○ BLU</p> <p>(Control circuit built in)</p>

OUTDOOR FAN MOTOR

Fan Motor Specifications

ITEM	MODEL	RAC-PH18WHLAE, RAC-PH24WHLAE
POWER SOURCE		DC: 300-380V
OUTPUT	(W) MAX	120W
COIL		<p>RED (U) BLACK (W) WHITE (V)</p>
RESISTANCE VALUE (Ω)	20°C (60°F)	2M U-V:22.4 ± 2.2Ω U-W:22.4 ± 2.2Ω W-V:22.4 ± 2.2Ω

BLU : BLUE
 GRY : GRAY
 BLK : BLACK

YEL : YELLOW
 ORN : ORANGE
 PNK : PINK

BRN : BROWN
 GRN : GREEN
 VIO : VIOLET

WHT : WHITE
 RED : RED

COMPRESSOR MOTOR

Compressor Motor Specifications

MODEL	RAC-PH18WHLAE		RAC-PH24WHLAE
COMPRESSOR MODEL	ATD186UKQA9LT6C		
PHASE	SINGLE		
RATED VOLTAGE	AC220V		
RATED FREQUENCY	50Hz		
POLE NUMBER	6		
CONNECTION			
RESISTANCE VALUE (Ω)	20°C (68°F)	2M	1.354

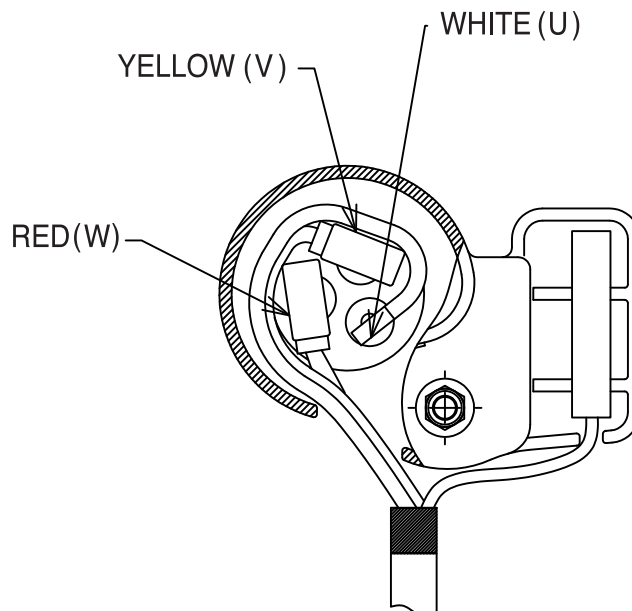

CAUTION

When the Air Conditioner has been operated for a long time with the capillary tubes clogged or crushed or with too little refrigerant, check the color of the refrigerant oil inside the compressor. If the color has been changed conspicuously, replace the compressor.

WIRING DIAGRAM

MODEL : RAS-PH18PHLAE / RAC-PH18WHLAE
RAS-PH24PHLAE / RAC-PH24WHLAE

INDOOR UNIT

BLU : BLUE	YEL : YELLOW	BRN : BROWN	WHT : WHITE
GRY : GRAY	ORN : ORANGE	GRN : GREEN	RED : RED
BLK : BLACK	PNK : PINK	VIO : VIOLET	IVO : IVORY

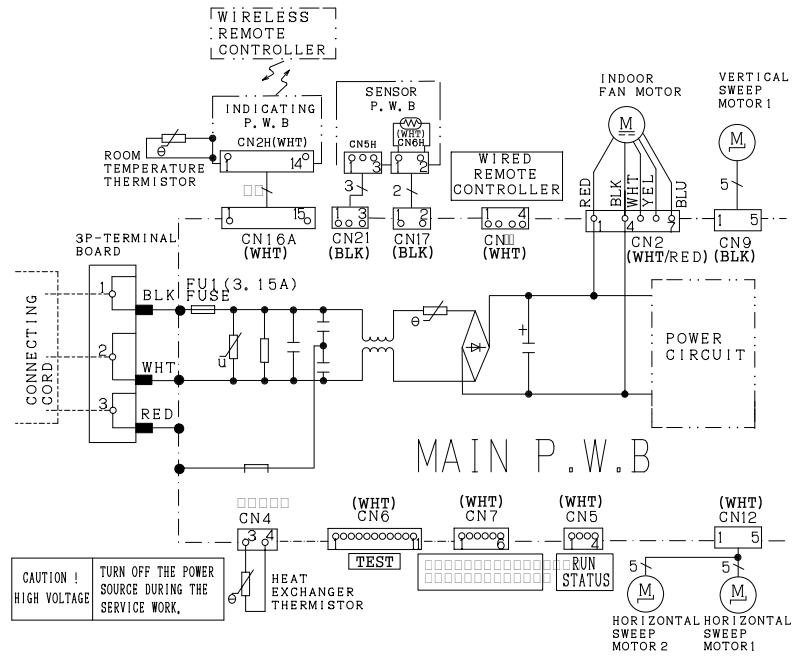

OUTDOOR UNIT

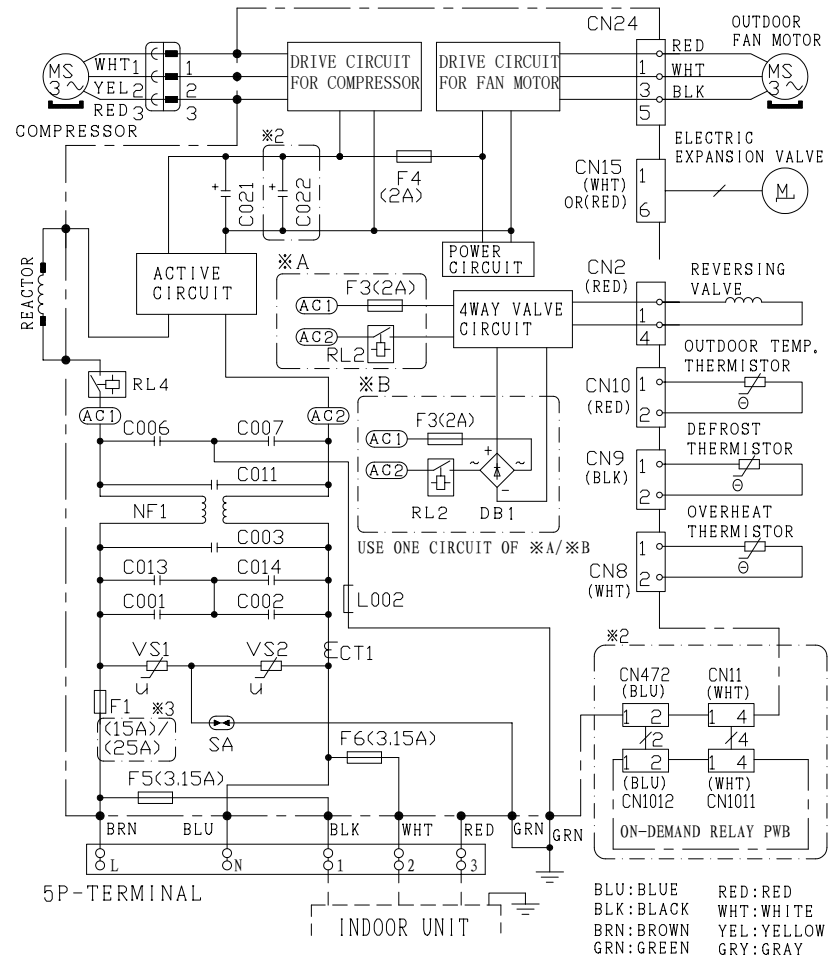

BLU: BLUE	RED: RED
BLK: BLACK	WHT: WHITE
BRN: BROWN	YEL: YELLOW
GRN: GREEN	GRY: GRAY

CIRCUIT DIAGRAM

Remote Controller

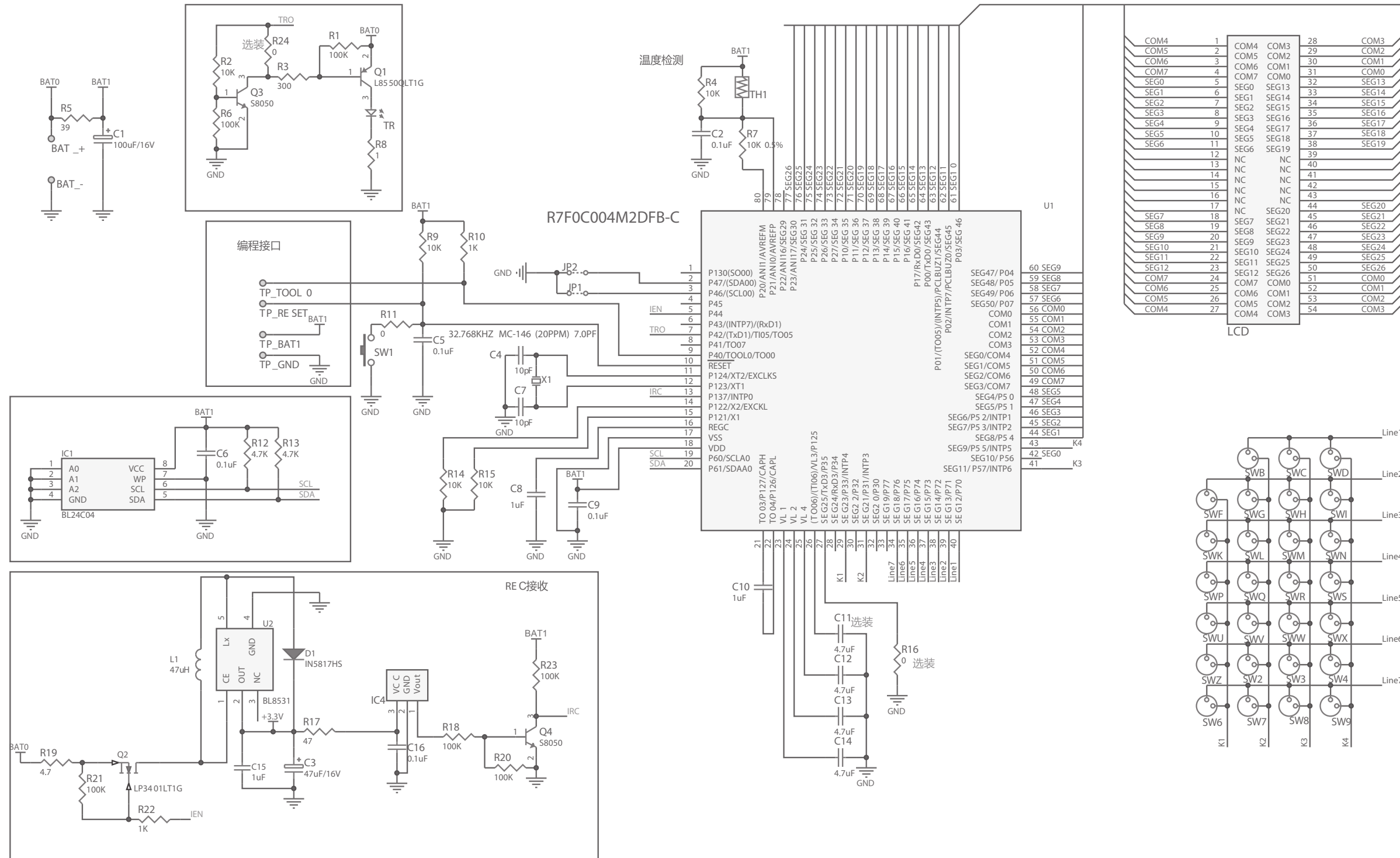

COM4	1	COM4	COM3	28	COM3
COM5	2	COM5	COM2	29	COM2
COM6	3	COM6	COM1	30	COM1
COM7	4	COM7	COM0	31	COM0
SEG0	5	SEG0	SEG13	32	SEG13
SEG1	6	SEG1	SEG14	33	SEG14
SEG2	7	SEG2	SEG15	34	SEG15
SEG3	8	SEG3	SEG16	35	SEG16
SEG4	9	SEG4	SEG17	36	SEG17
SEG5	10	SEG5	SEG18	37	SEG18
SEG6	11	SEG6	SEG19	38	SEG19
	12	NC	NC	39	
	13	NC	NC	40	
	14	NC	NC	41	
	15	NC	NC	42	
	16	NC	NC	43	
	17	NC	NC	44	
SEG7	18	NC	SEG20	45	SEG20
SEG8	19	SEG7	SEG21	46	SEG21
SEG9	20	SEG8	SEG22	47	SEG22
SEG10	21	SEG9	SEG23	48	SEG23
SEG11	22	SEG10	SEG24	49	SEG24
SEG12	23	SEG11	SEG25	50	SEG25
	24	SEG12	SEG26	51	SEG26
COM7	24	COM7	COM1	51	COM1
COM6	25	COM6	COM0	52	COM0
COM5	26	COM5	COM2	53	COM2
COM4	27	COM4	COM3	54	COM3

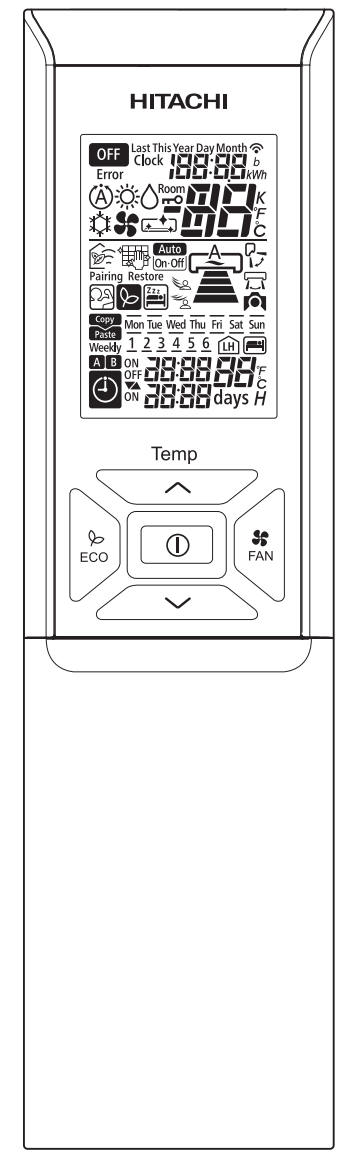
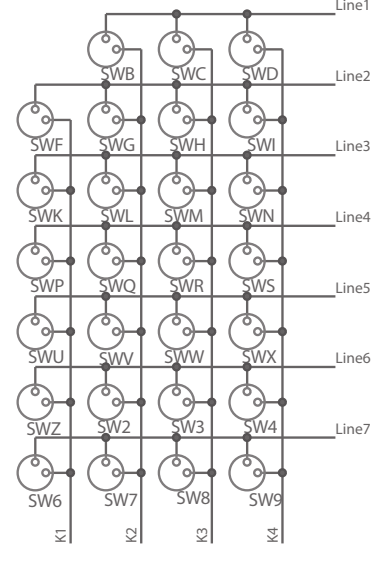

CIRCUIT DIAGRAM
MODEL RAS-PH18PHLAE, RAS-PH24PHLAE

- NOTES:**
1. TYPE OF CAPACITOR
 F- FILM CAPACITOR
 C- CERAMIC CAPACITOR
 D- ELECTROLYTIC CAPACITOR
 2. MOUNTING TYPE
 A- AXIAL
 R- RADIAL
 P- RADIAL (7.5mm PITCH)
 H- HAND INSERT
 OS- SURFACE MOUNT(SMT)
 S- IN ADDITION SURFACE MOUNTING
 3. MOUNTING FACE
 A- COMPONENT SIDE
 B- SOLDER SIDE
 4. PCB DETAILS--

BOARD	TYPE	DRAWING	FORM
MAIN PWB	#HBOARD-AS	DD0010111A	A/R,C,S
INDICATION PWB	#HBOARD-AS	DD0007560D	A/R,C,S,H
SENSOR PWB	#MS-BOARD	DD0006633C	A/R,C,S,H
		DD0006633B	A/R,C,S,H

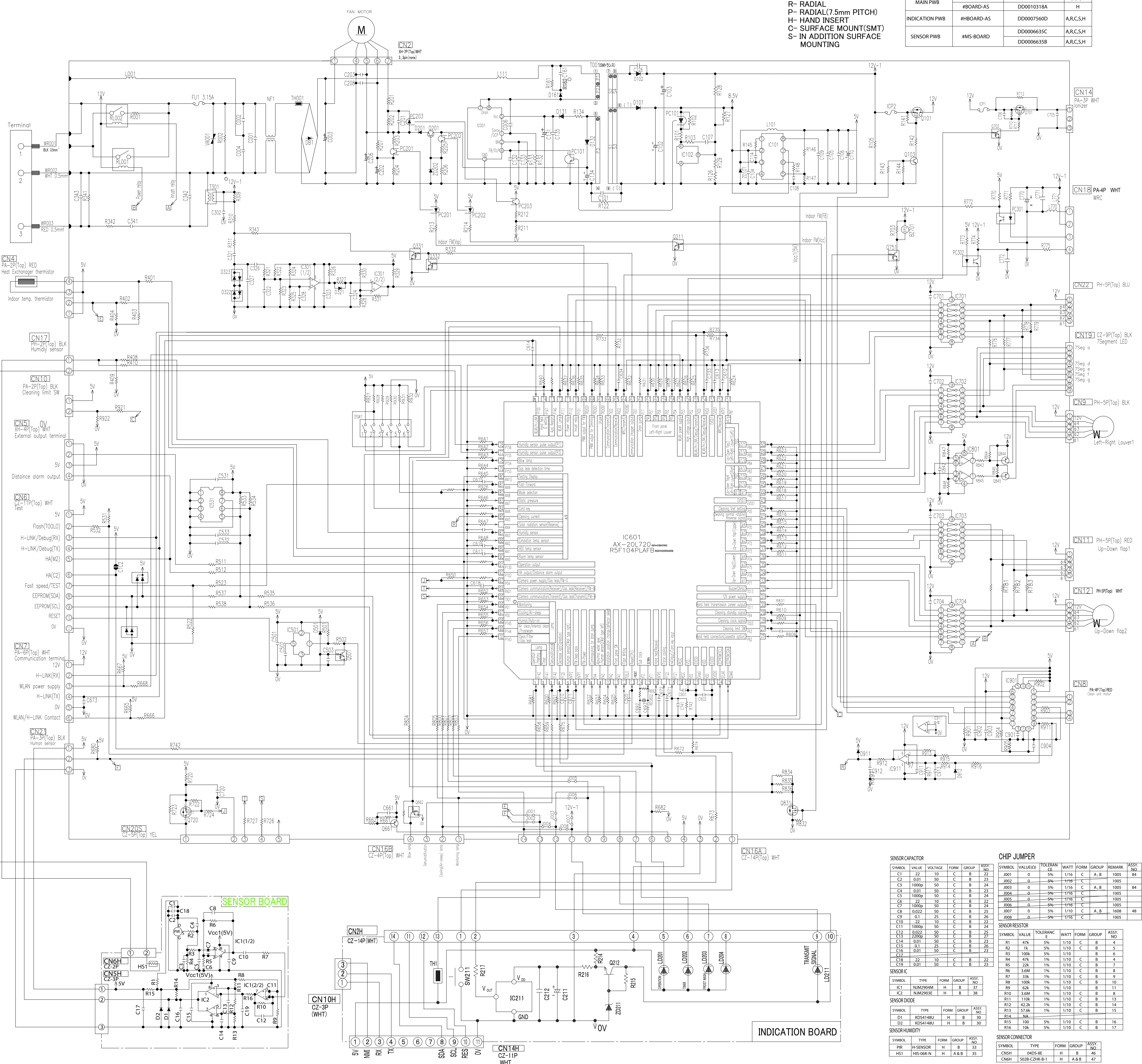

RESISTOR

SYMBOL	VALUE	TOLERANCE	WATT	FORM	GROUP	REMARK	ASSY NO.
R001	510	5%	1/4	A	A,B	HVL	17
R002	1M	5%	1/4	A	A,B	HVL	17
R101	1k	5%	1/4	C	A,B	3226	18
R102	1.5k	5%	1/10	C	A,B	1608	56
R103	10k	5%	1/10	C	A,B	1608	61
R105	3k	5%	1/10	C	A,B	1608	57
R122	33M	5%	1/2	A	A,B	HVL	18
R126	16k	1%	1/10	C	A,B	1608	39
R127	330k	1%	1/10	C	A,B	1608	40
R128	100k	1%	1/10	C	A,B	1608	41
R129	6.2k	1%	1/10	C	A,B	1608	46
R132	1.2	5%	1	R	A,B	MOS	7
R133	330k	5%	1/10	C	A,B	1608	63
R134	22	5%	1/2	A	A,B	RSS	11
R141	100k	5%	1/16	C	A,B	1005	53
R142	100k	5%	1/16	C	A,B	1005	53
R143	3.3k	5%	1/16	C	A,B	1005	77
R144	3.3k	5%	1/16	C	A,B	1005	77
R145	0	5%	1/10	C	A,B	1608	48
R146	40.2k	1%	1/10	C	A,B	1608	35
R147	9.1k	1%	1/10	C	A,B	1608	36
R148	11k	1%	1/10	C	A,B	1608	37
R161	220k	5%	1	R	A,B	HTF1903	8
R162	6k	5%	1	R	A,B	12	12
R201	4.3k	5%	1/4	C	A,B	3216	28
R202	4.3k	5%	1/4	C	A,B	3216	28
R203	4.7k	5%	1/8	C	A,B	2125	43
R204	3.3k	5%	1/10	C	A,B	1608	58
R205	402	1%	1/4	C	A,B	3216	31
R206	33k	5%	1/16	C	A,B	1005	62
R207	100	5%	1/10	C	A,B	1608	52
R211	10k	5%	1/10	C	A,B	1608	61
R212	1k	5%	1/10	C	A,B	1608	60
R213	39k	1%	1/8	C	A,B	2125	49
R214	560	5%	1/4	C	A,B	3226	19
R309	680	5%	1/4	C	A,B	3216	29
R310	180	5%	1/8	C	A,B	2125	33
R311	3.3k	1%	1/8	C	A,B	2125	34
R321	1k	5%	1/16	C	A,B	1005	81
R322	10.5k	1%	1/16	C	A,B	1005	75
R323	10k	1%	1/16	C	A,B	1005	73
R324	21.5k	1%	1/16	C	A,B	1005	76
R325	10k	1%	1/16	C	A,B	1005	73
R326	71.5k	1%	1/16	C	A,B	1005	76
R327	51k	5%	1/16	C	A,B	1005	85
R328	71.5k	5%	1/16	C	A,B	1005	76
R329	5.6k	5%	1/16	C	A,B	1005	71
R330	5.6k	1%	1/16	C	A,B	1005	71
R331	8.25k	1%	1/10	C	A,B	1005	69
R332	5.6k	1%	1/16	C	A,B	1005	71
R341	470k	5%	1/4	A	A,B	16	16
R342	47	5%	1/4	A	A,B	16	16
R343	91	1%	1/4	C	A,B	3216	30
R401	1k	5%	1/16	C	A,B	1005	81
R402	1k	5%	1/16	C	A,B	1005	81
R403	12.2k	1%	1/16	C	A,B	1005	67
R404	12.2k	1%	1/16	C	A,B	1005	67
R408	1k	5%	1/16	C	A,B	1005	81
R410	47k	1%	1/16	C	A,B	1005	82
R501	300k	5%	1/16	C	A,B	1005	86
R502	1k	5%	1/16	C	A,B	1005	81
R511	1k	5%	1/16	C	A,B	1005	81
R512	1k	5%	1/16	C	A,B	1005	81
R522	10k	5%	1/16	C	A,B	1005	68
R523	1k	5%	1/16	C	A,B	1005	81
R531	1k	5%	1/16	C	A,B	1005	81
R532	100	5%	1/16	C	A,B	1005	54
R533	2.2k	5%	1/16	C	A,B	1005	78
R534	2.2k	5%	1/16	C	A,B	1005	78
R535	100	5%	1/16	C	A,B	1005	54
R536	100	5%	1/16	C	A,B	1005	54
R537	100	5%	1/16	C	A,B	1005	54
R538	100	5%	1/16	C	A,B	1005	54
R600	10k	5%	1/16	C	A,B	1005	68
R601	10k	5%	1/16	C	A,B	1005	68
R602	10k	5%	1/16	C	A,B	1005	68
R603	10k	5%	1/16	C	A,B	1005	68
R604	10k	5%	1/16	C	A,B	1005	68
R605	10k	5%	1/16	C	A,B	1005	68
R606	10k	5%	1/16	C	A,B	1005	68
R607	10k	5%	1/16	C	A,B	1005	68
R608	10k	5%	1/16	C	A,B	1005	68
R609	10k	5%	1/16	C	A,B	1005	68
R610	10k	5%	1/16	C	A,B	1005	68
R611	10k	5%	1/16	C	A,B	1005	68
R612	10k	5%	1/16	C	A,B	1005	68
R613	10k	5%	1/16	C	A,B	1005	68
R614	10k	5%	1/16	C	A,B	1005	68
R615	10k	5%	1/16	C	A,B	1005	68
R616	10k	5%	1/16	C	A,B	1005	68
R617	10k	5%	1/16	C	A,B	1005	68
R618	10k	5%	1/16	C	A,B	1005	68
R619	10k	5%	1/16	C	A,B	1005	68
R620	10k	5%	1/16	C	A,B	1005	68
R621	10k	5%	1/16	C	A,B	1005	68
R622	10k	5%	1/16	C	A,B	1005	68
R623	10k	5%	1/16	C	A,B	1005	68
R624	10k	5%	1/16	C	A,B	1005	68
R625	10k	5%	1/16	C	A,B	1005	68
R626	10k	5%	1/16	C	A,B	1005	68
R627	10k	5%	1/16	C	A,B	1005	68
R628	10k	5%	1/16	C	A,B	1005	68
R629	10k	5%	1/16	C	A,B	1005	68
R630	10k	5%	1/16	C	A,B	1005	68
R631	10k	5%	1/16	C	A,B	1005	68
R632	10k	5%	1/16	C	A,B	1005	68
R633	10k	5%	1/16	C	A,B	1005	68
R634	10k	5%	1/16	C	A,B	1005	68
R635	10k	5%	1/16	C	A,B	1005	68
R636	10k	5%	1/16	C	A,B	1005	68
R637	10k	5%	1/16	C	A,B	1005	68
R638	10k	5%	1/16	C	A,B	1005	68
R639	10k	5%	1/16	C	A,B	1005	68
R640	10k	5%	1/16	C	A,B	1005	68
R641	10k	5%	1/16	C	A,B	1005	68
R642	10k	5%	1/16	C	A,B	1005	68
R643	10k	5%	1/16	C	A,B	1005	68
R644	10k	5%	1/16	C	A,B	1005	68
R645	10k	5%	1/16	C	A,B	1005	68
R646	10k	5%	1/16	C	A,B	1005	68
R647	10k	5%	1/16	C	A,B	1005	68
R648	10k	5%	1/16	C	A,B	1005	68
R649	10k	5%	1/16	C	A,B	1005	68
R650	10k	5%	1/16	C	A,B	1005	68

RESISTOR

SYMBOL	VALUE	TOLERANCE	WATT	FORM	GROUP	REMARK	ASSY NO.
R651	10k	5%	1/16	C	A,B	1005	68
R652	10k	5%	1/16	C	A,B	1005	68
R653	10k	5%	1/16	C	A,B	1005	68
R654	10k	5%	1/16	C	A,B	1005	68
R655	10k	5%	1/16	C	A,B	1005	68
R656	10k	5%	1/16	C	A,B	1005	68
R657	10k	5%	1/16	C	A,B	1005	68
R658	750	5%	1/10	C	A,B	1608	54
R659	390	5%	1/10	C	A,B	1608	88
R660	1k	5%	1/16	C	A,B	1005	81
R661	2.2k	5%	1/10	C	A,B	1608	79
R662	4.3k	5%	1/10	C	A,B	1608	59
R665	10k	5%	1/16	C	A,B	1005	68
R666	1k	5%	1/16	C	A,B	1005	81
R667	10k	5%	1/16	C	A,B	1005	68
R668	1k	5%	1/16	C	A,B	1005	81
R669	300	5%	1/10	C	A,B	1608	81
R671	10k	5%	1/16	C	A,B	1005	68
R672	1k	5%	1/16	C	A,B	1005	81
R673	1k	5%	1/16	C	A,B	1005	81
R674	390	5%	1/10	C	A,B	1608	88
R675	750	5%	1/10	C	A,B	1608	64
R680	10k	5%	1/16	C	A,B	1005	68
R681	390	5%	1/10	C	A,B	1608	88
R691	0	5%	1/16	C	A,B	1005	84
R692	5%	1/16	C	A,B	1005	84	
R702	3.3k	5%	1/10	C	A,B	1608	58
R710	100k	5%	1/16	C	A,B	1005	68
R711	100k	5%	1/16	C	A,B	1005	68
R712	5%	1/16	C	A,B	1005	68	
R720	0	5%	1/10	C	A,B	1608	62
R722	100k	5%	1/16	C	A,B	1005	68
R723	5%	1/16	C	A,B	1005	68	
R724	31k	5%	1/16	C	A,B	1005	68
R725	100	5%	1/16	C	A,B	1005	68
R726	100	5%	1/16	C	A,B	1005	68
R732	10k	5%	1/16	C	A,B	1005	68
R733	31k	5%	1/16	C	A,B	1005	68
R734	10k	5%	1/16	C	A,B	1005	68
R735	10k	5%	1/16	C	A,B	1005	68
R736	1k	5%	1/16	C	A,B	1005	81
R742	1k	5%	1/16	C	A,B	1005	81
R743	10k	5%	1/16	C	A,B	1005	68
R770	2k	5%	1/10	C	A,B	1608	93
R771	1.2k	5%	1/4	C	A,B	3216	25
R772	1k	5%	1/16	C	A,B	1005	81
R773	560	5%	1/10	C	A,B	1608	89
R774	2k	5%	1/4	C	A,B	3216	92
R775	620	5%	1/8	C	A,B	2125	45
R776	0	5%	1/16	C	A,B	1005	80
R777	0	5%	1/16	C	A,B	1005	80
R778	0	5%	1/16	C	A,B	1005	80
R779	0	5%	1/16	C	A,B	1005	80
R780	0	5%	1/16	C	A,B	1005	80
R781	0	5%	1/16	C	A,B	1005	80
R782	0	5%	1/16	C	A,B	1005	80
R783	0	5%	1/16	C	A,B	1005	80
R800	300	5%	1/10				

PRINTED BOARD LOCATION DIAGRAM

MODEL RAS-PH18PHLAE, RAS-PH24PHLAE

MAIN P.W.B

Marking on P.W.B

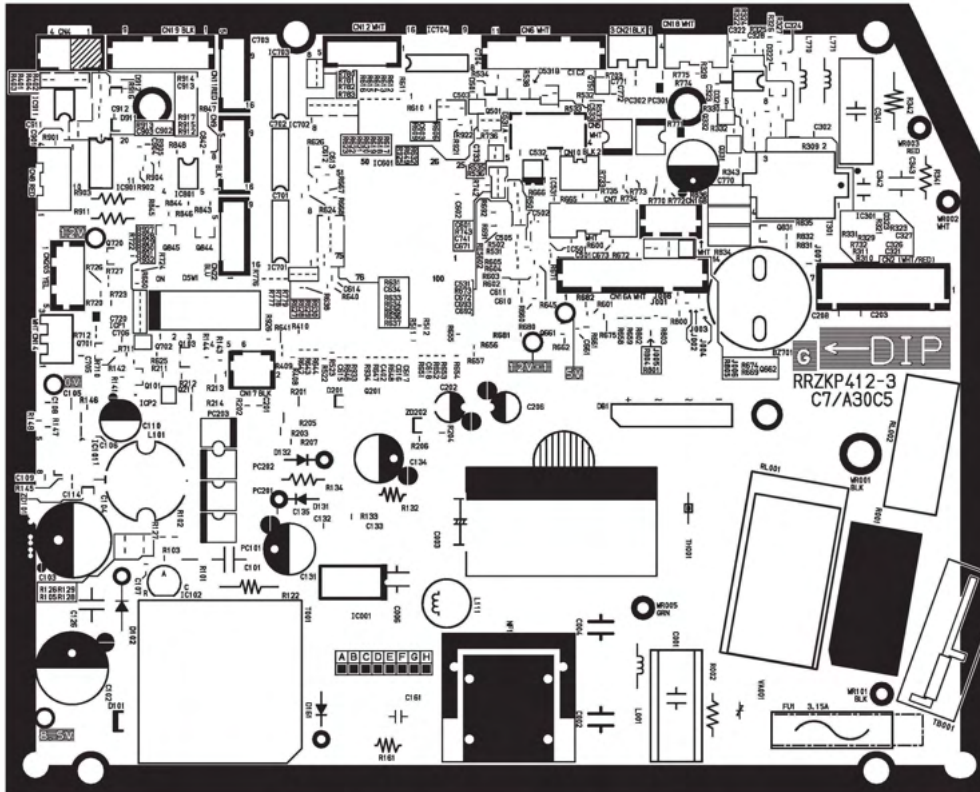

RECEIVING P.W.B
Marking on P.W.B

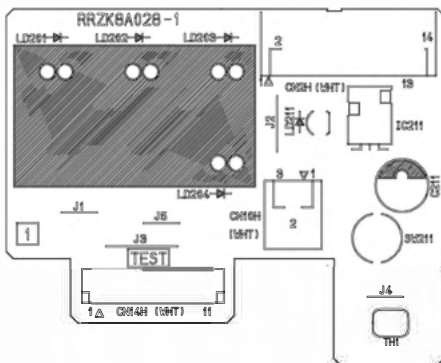

SENSOR P.W.B
Marking on P.W.B

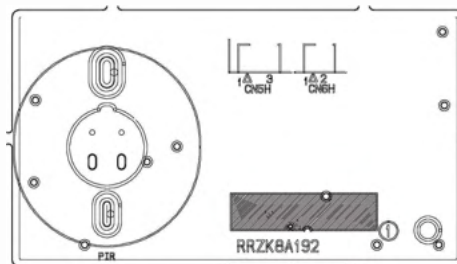

MAIN PWB
 MODEL RAC-PH18WHLAE
 RAC-PH24WHLAE

Top side

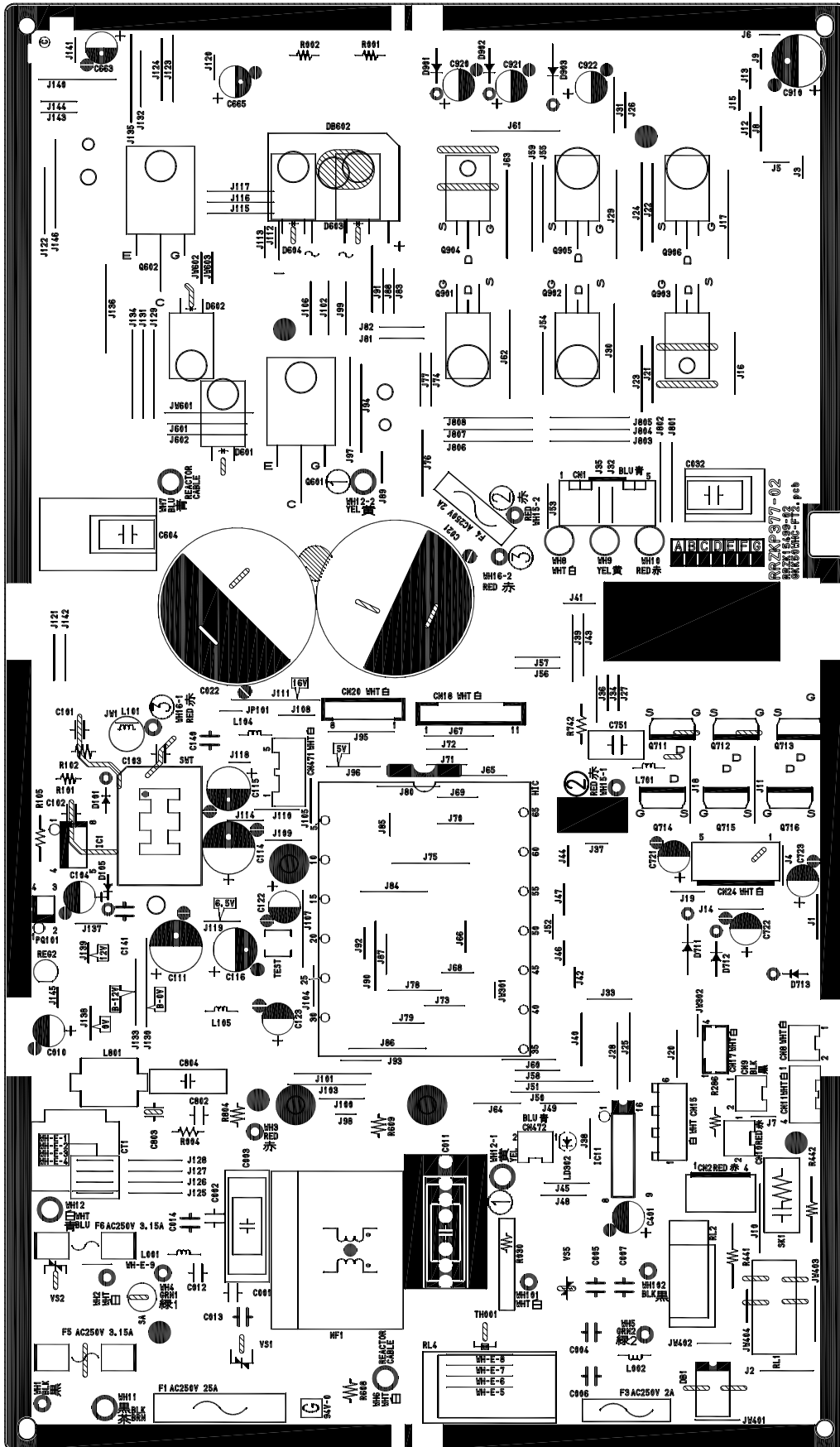

MAIN PWB
MODEL RAC-PH18WHLAE
RAC-PH24WHLAE

Bottom side

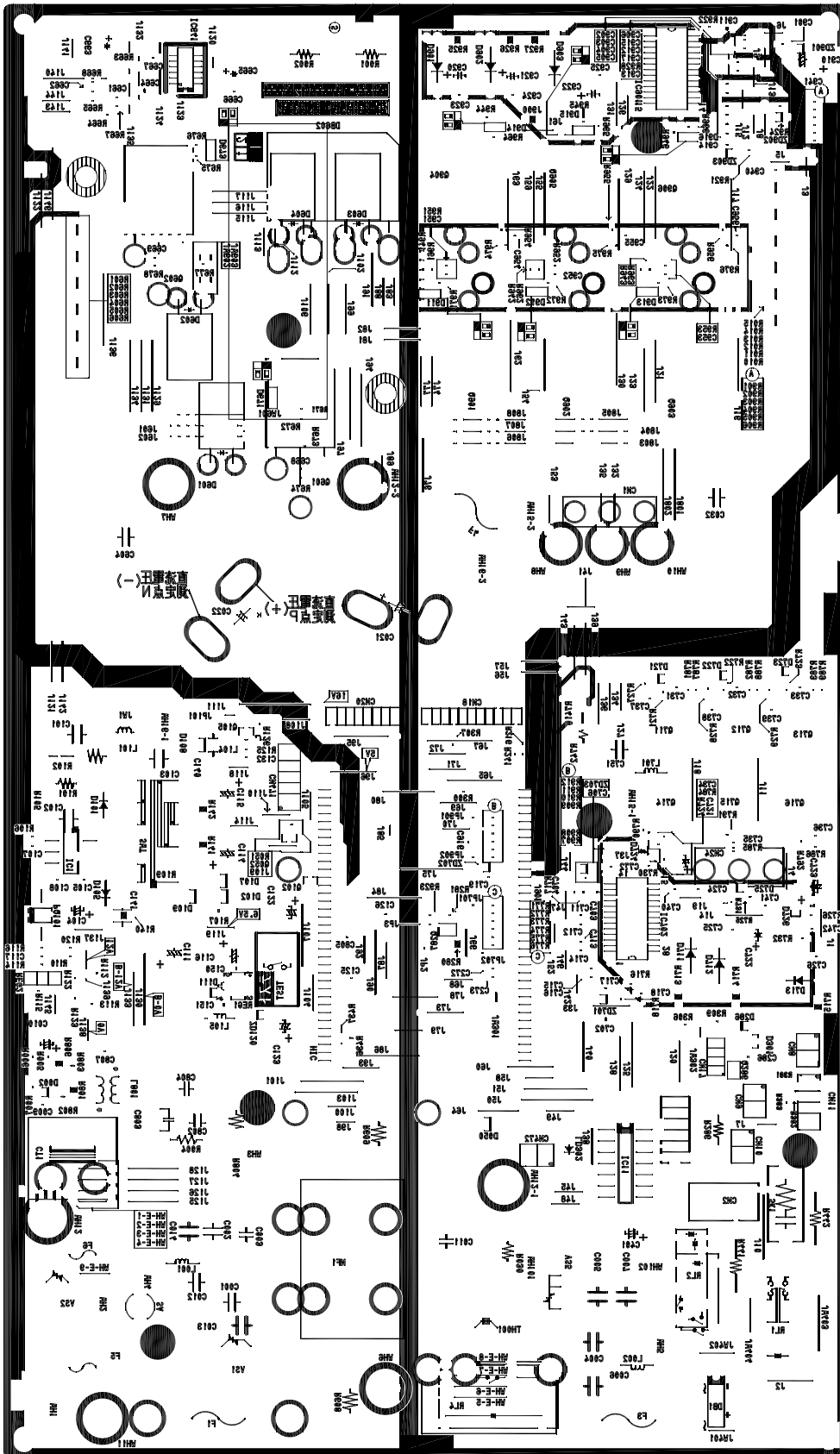

HIC PWB

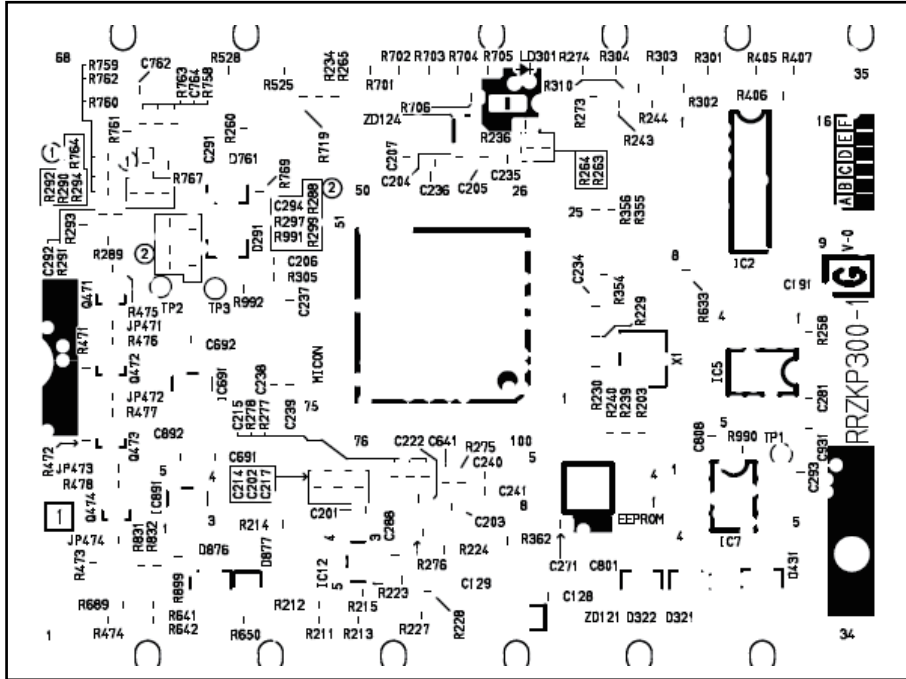

Top side

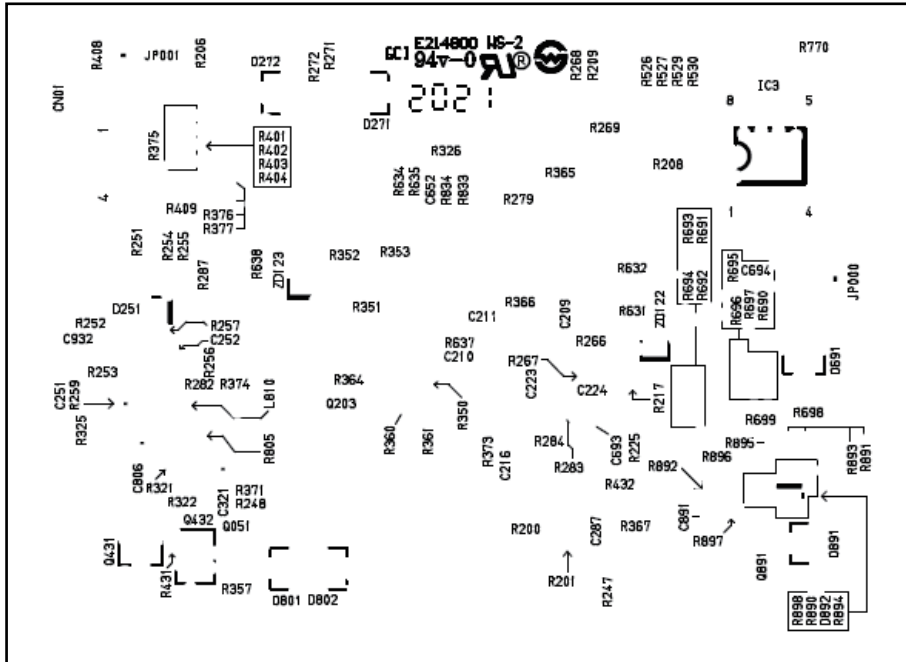

Bottom side

RELAY PWB

MODEL RAC-PH18WHLAE
RAC-PH24WHLAE

Top side

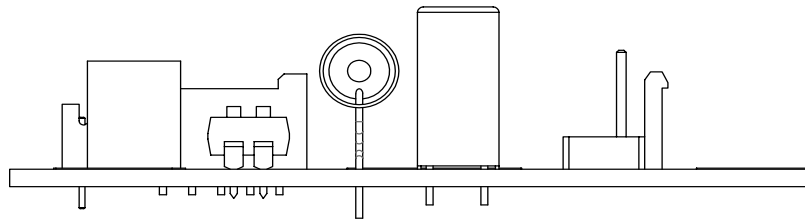
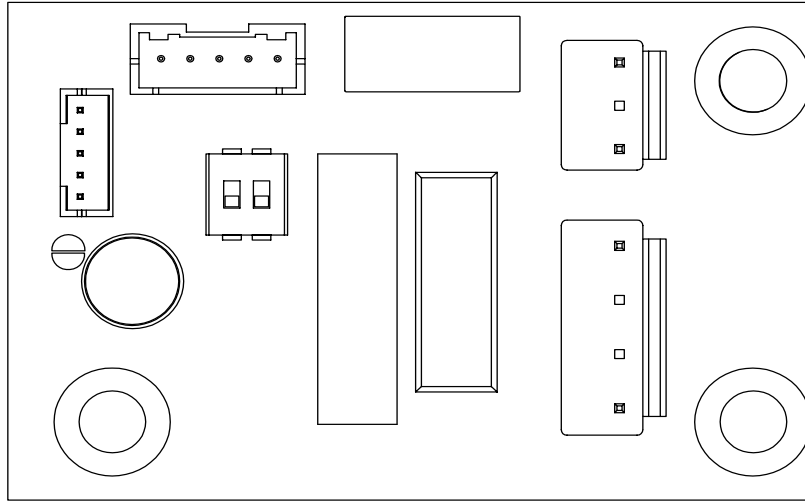

Bottom side

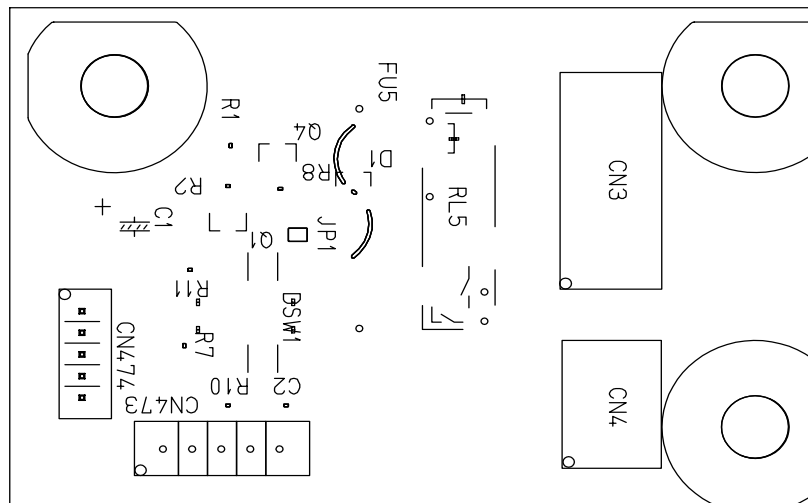

BLOCK DIAGRAM

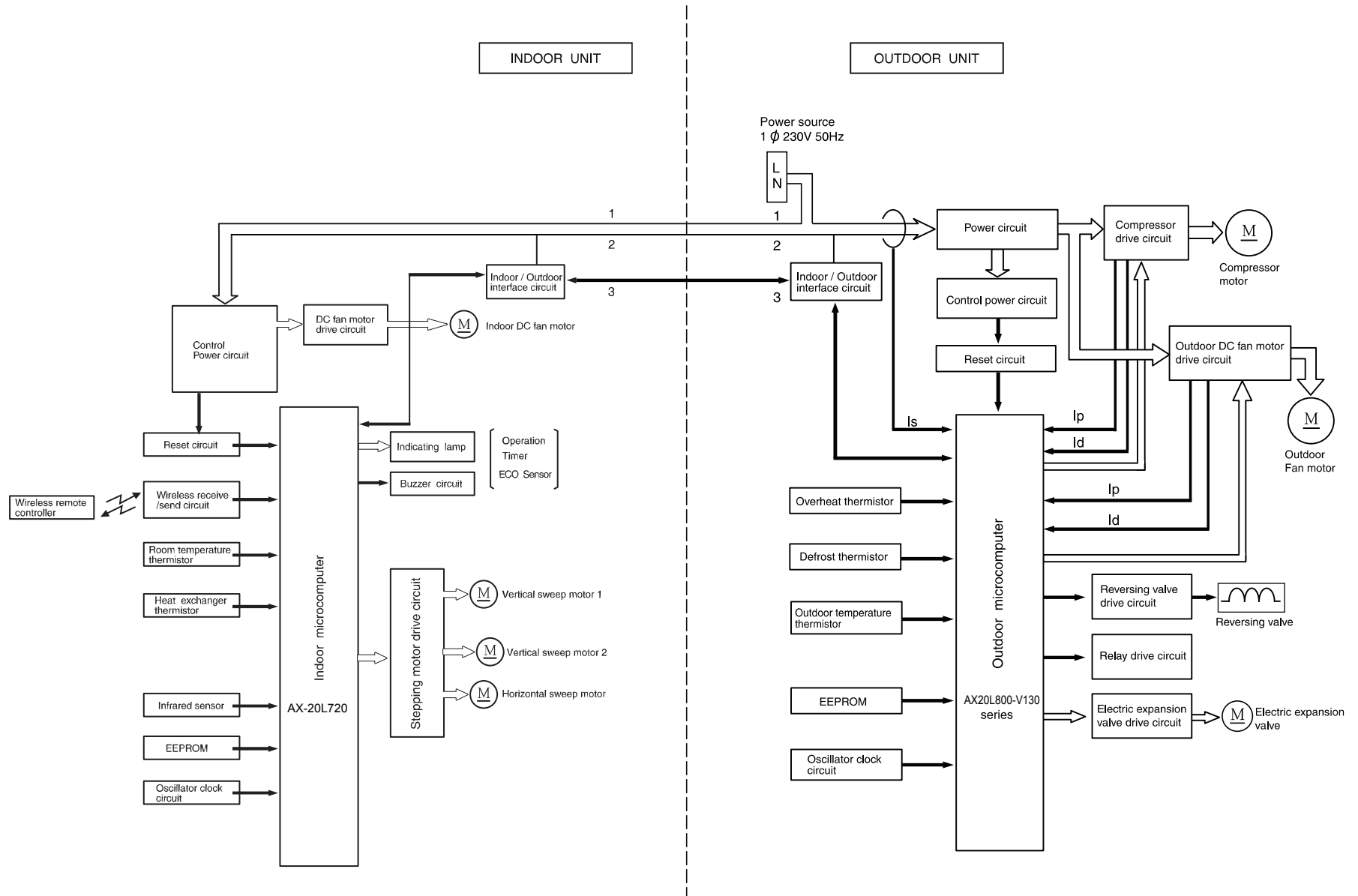

BASIC MODE

Operation mode	Fan	Cooling	Dehumidifying	Heating	Auto	
Basic operation of start/stop button						
Timer functions	Off-timer					
	On-timer					
Fan speed mode (indoor fan)	Auto	<p>Changes from "Hi" to "Med" or "Lo" depending on room temperature.</p> <p>1. Runs at "Hi" until room temperature reaches to "setting temperature-SFTDSC" after operation is started. 2. Runs at "ultra-Lo" when thermo is off.</p>		<p>Set to "ultra-Lo", "Silent", "Lo", "Med", "Hi", "ultra-Hi" or "stop" depending on the room temperature, time and heat exchanger temperature. Set to "stop" if the heat exchanger temperature is "DNZKOF" during Thermo OFF. (When reach at "DNZKON", fan speed set to "ultra-Lo" again.)</p>	<p>Operating mode is judged by room temperature.</p> <p>(1) Judging by room temperature (Initial judgement)</p> <p>(a) Conditions for judgment (any of the followings).</p> <ul style="list-style-type: none"> When auto operation is started after the previous auto mode operation. When auto operation is started after the previous manual mode operation. When the operating mode is switched to auto while operating at manual mode. <p>(b) Judging method</p> <ul style="list-style-type: none"> [Cooling] : Room temperature \geq Remote controller setting [Heating] : Room temperature $<$ Remote controller setting 	
	Hi	Operates at "Hi" regardless of the room temperature.	Set to "ultra-Hi" when the compressor runs at cold dash mode speed, and to "Hi" in other modes. Runs at "ultra-Lo" when thermo is off.		Set to "ultra-Lo", "Silent", "Lo", "Med", "Hi", "ultra-Hi" or "stop" depending on the room temperature, time and heat exchanger temperature. Set to "stop" if the heat exchanger temperature is "DNZKOF" during Thermo OFF. (When reach at "DNZKON", fan speed set to "ultra-Lo" again.)	<p>(2) Judging by room temperature (continuous judgement)</p> <p>(a) Judging condition</p> <ul style="list-style-type: none"> Operating mode will be judge again after auto mode interval time (1) 1st interval [auttmn1_8u] (2) 2nd interval [auttmn2_8u] (3) 3rd and next interval [auttmn3_8u] <p>(b) Judging method</p> <ul style="list-style-type: none"> Judging method will follow as below Final set temperature is remote controller setting including shift value <p>[Current operation is COOLING]</p> <ul style="list-style-type: none"> Room temperature \leq Final set temperature - [nwaitw_8u], change to HEATING Room temperature $>$ Final set temperature - [nwaitw_8u], continue in COOLING <p>[Current operation is HEATING]</p> <ul style="list-style-type: none"> Room temperature \geq Final set temperature + [nwaitc_8u], change to COOLING Room temperature $>$ Final set temperature + [nwaitc_8u], continue in HEATING
	Med	Operates at "Med" regardless of the room temperature.	Operates at "Med" regardless of the room temperature. Runs at "ultra-Lo" when thermo is off.		Set to "ultra-Lo", "Silent", "Lo", "Med", "Hi", "ultra-Hi" or "stop" depending on the room temperature, time and heat exchanger temperature. Set to "stop" if the heat exchanger temperature is "DNZKOF" during Thermo OFF. (When reach at "DNZKON", fan speed set to "ultra-Lo" again.)	
	Lo	Operates at "Lo" regardless of the room temperature.	Operates at "Lo" regardless of the room temperature. Runs at "ultra-Lo" when thermo is off.	Set to "Lo" in modes other than when the compressor stops.	Set to "ultra-Lo", "Silent", "Lo", "Med", "Hi", "ultra-Hi" or "stop" depending on the room temperature, time and heat exchanger temperature. Set to "stop" if the heat exchanger temperature is "DNZKOF" during Thermo OFF. (When reach at "DNZKON", fan speed set to "ultra-Lo" again.) The fan speed is controlled by the heat exchanger temperature; the overload control is executed as in the following diagram:	
	Silent	Operates at "Silent" regardless of the room temperature.	Operates at "Silent" regardless of the room temperature. Runs at "ultra-Lo" when thermo is off.	Set to "Silent" in modes other than when the compressor stops.		
Basic operation of temperature controller	Performs only fan operation at the set speed regardless of the room temperature.	See page 67.	See page 69.	See page 71.	Follow basic cooling or heating operation	

Basic Cooling Operation

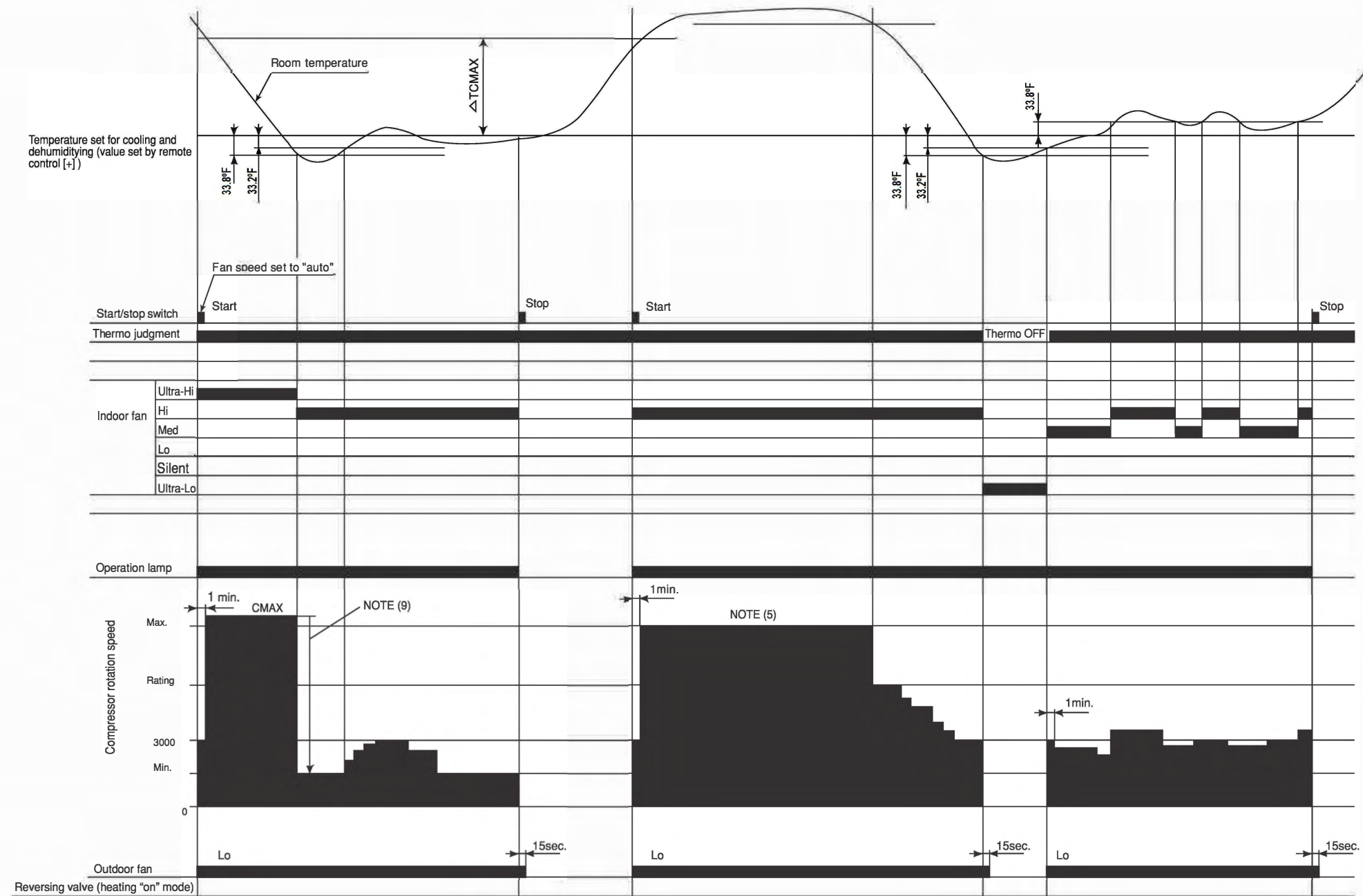

Notes:

- (1) Condition for entering into Cool Dashed mode. When fan set to "Hi" or "Auto and when the compressor speed (P section) due to temperature difference between setting temperature (including the correction shift only) and room temperature is CMAX or higher.
- (2) Cool Dashed will release when i) a maximum 25 minutes is lapsed and ii) room temperature is lower than set temperature 26.6°F (thermo off) and iii) when room temperature has achieved setting temperature 30.2°F then maximum Cool Dashed time will be revised to 20 minutes. And iv) indoor fan is set to Lo and Med fan mode and v) change operation mode.
- (3) During Cool Dashed operation, thermo off temperature is set temperature (with shift value) 26.6°F. After thermo off, operation continue in Fuzzy control mode.
- (4) Compressor minimum "ON" time and "OFF" time is 3 minutes.
- (5) During normal cooling mode, compressor maximum rpm CMAX will maintain for 60 minutes if indoor temperature is lower than CLMXTP. No time constrain if indoor temperature is higher than CLMXTP.
- (6) When fan is set to "Hi", compressor rpm will be limited to CSTD.
- (7) When fan is set to "Med", compressor rpm will be limited to CJKMAX.
- (8) When fan is set to "Lo", compressor rpm will be limited to CBEMAX.
- (9) During Cool Dashed, when room temperature reaches set temperature 30.2°F compressor rpm is actual rpm x DWNRATEC.

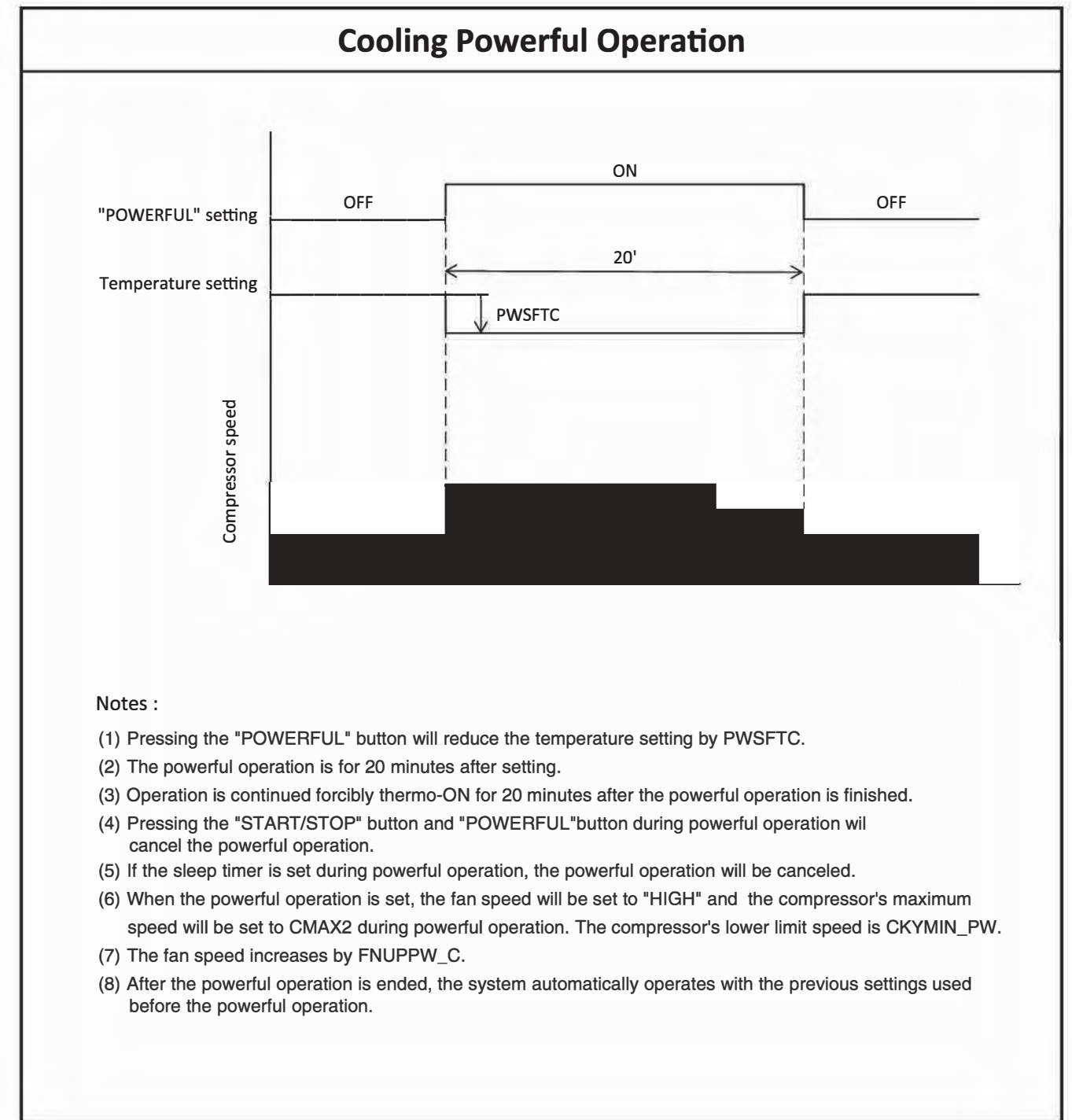
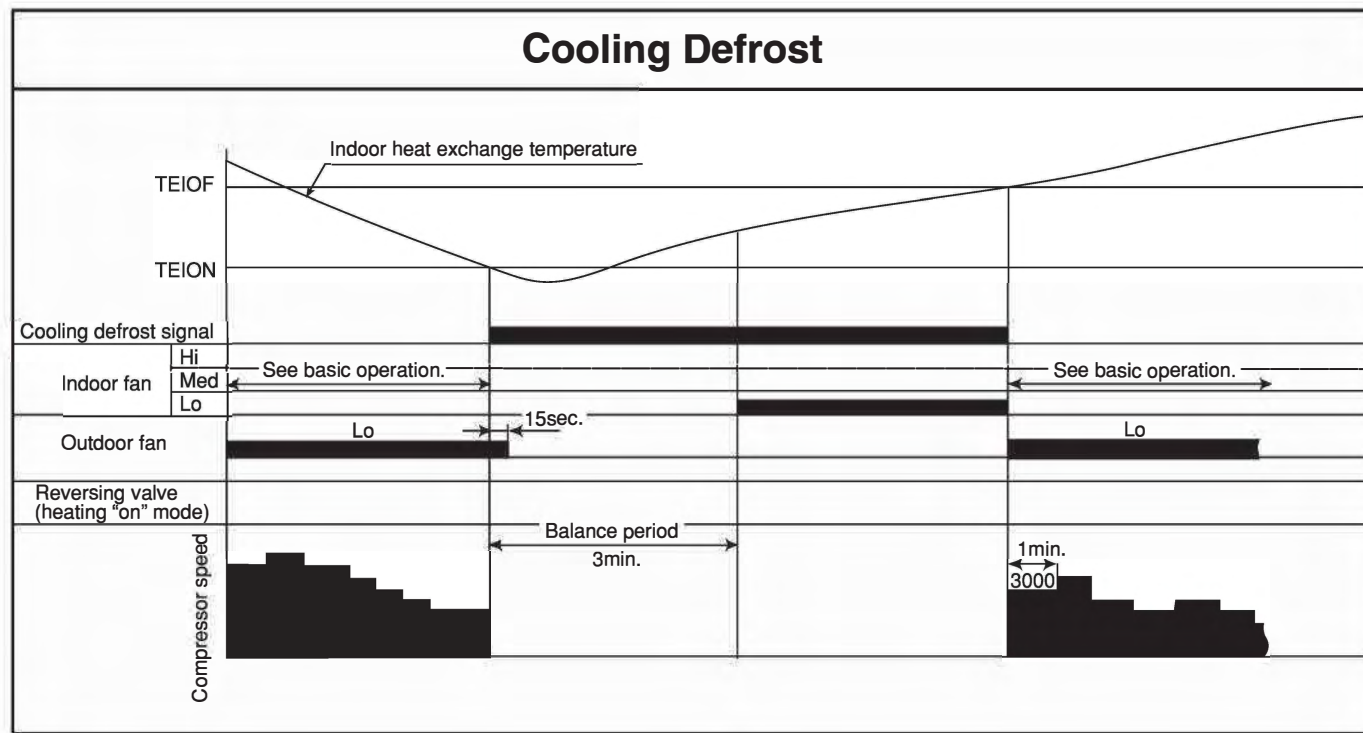

Notes :

- (1) Pressing the "POWERFUL" button will reduce the temperature setting by PWSFTC.
- (2) The powerful operation is for 20 minutes after setting.
- (3) Operation is continued forcibly thermo-ON for 20 minutes after the powerful operation is finished.
- (4) Pressing the "START/STOP" button and "POWERFUL" button during powerful operation will cancel the powerful operation.
- (5) If the sleep timer is set during powerful operation, the powerful operation will be canceled.
- (6) When the powerful operation is set, the fan speed will be set to "HIGH" and the compressor's maximum speed will be set to CMAX2 during powerful operation. The compressor's lower limit speed is CKYMIN_PW.
- (7) The fan speed increases by FNUPPW_C.
- (8) After the powerful operation is ended, the system automatically operates with the previous settings used before the powerful operation.

Dehumidifying

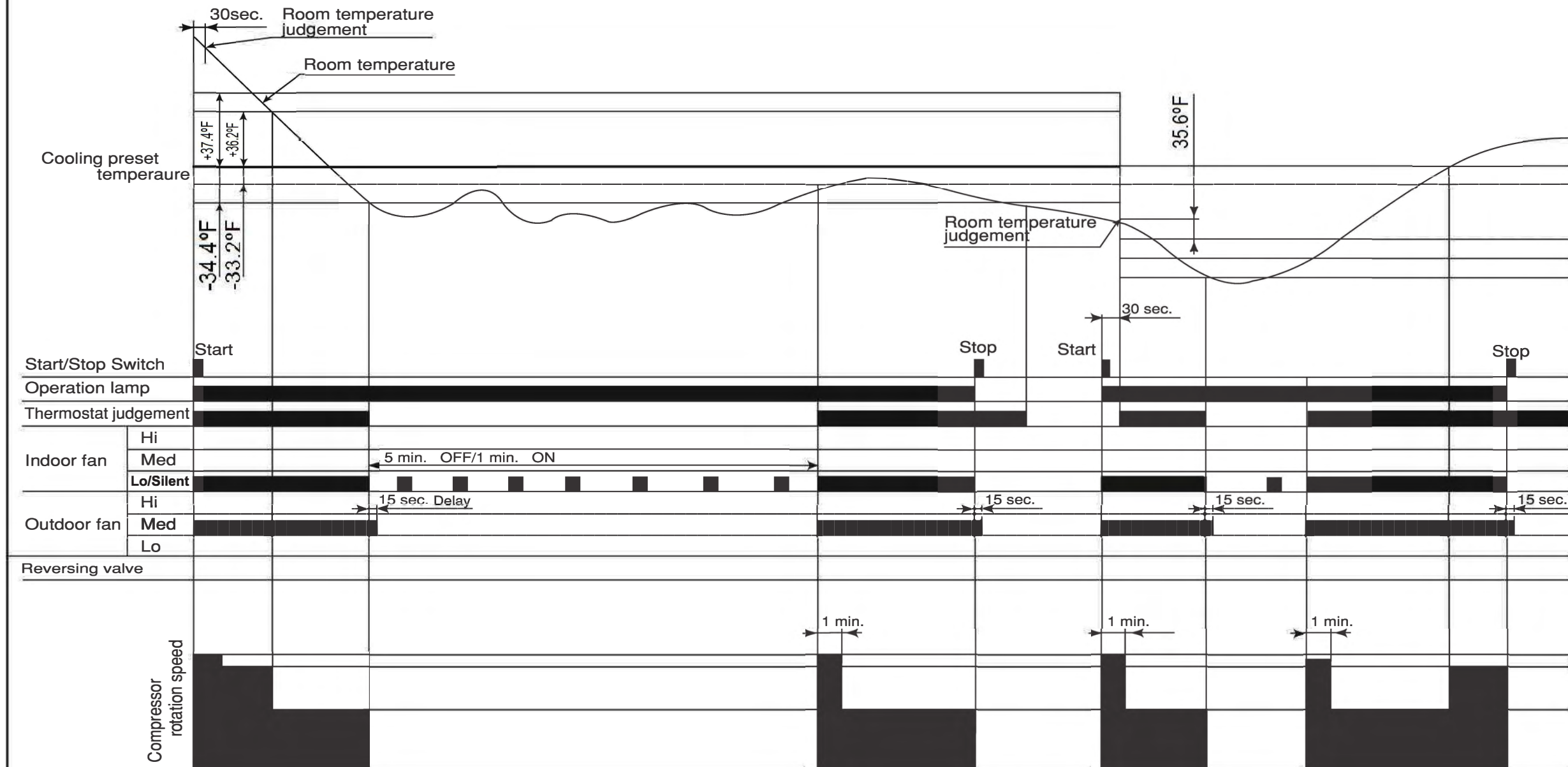

Notes:

- (1) If the room temperature is (cooling preset temperature) - (34.4°F) or less after 30 seconds from starting the operation, the operation is done assuming as the preset temperature = (room temperature at the time) - (35.6°F).
- (2) The indoor fan is operated in the "Lo" or "Silent" mode. During thermo OFF, indoor fan will be OFF 5 minutes and ON for 1 minute
- (3) When the operation is started by the thermostat turning ON, the start of the indoor fan is delayed 32 seconds after the start of compressor operation.
- (4) The compressor is operated forcedly for 3 minutes after operation is started.
- (5) The minimum ON time and OFF time of the compressor are 3 minutes.

Dehumidifying Powerful Operation

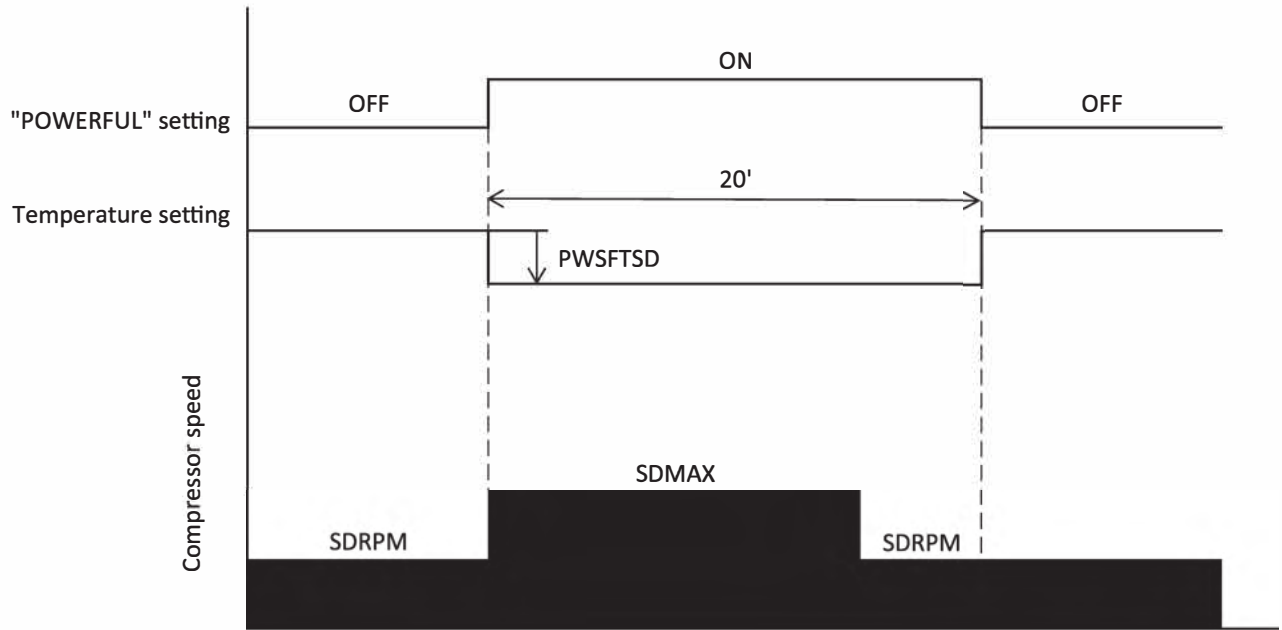

Notes :

- (1) Pressing the "POWERFUL" button will reduce the temperature setting by PWSFTSD.
- (2) The powerful operation is for 20 minutes after setting.
- (3) Operation is continued forcibly thermo-ON for 20 minutes after the powerful operation is finished.
- (4) Pressing the "START/STOP" button and "POWERFUL" button during powerful operation will cancel the powerful operation.
- (5) If the sleep timer is set during powerful operation, the powerful operation will be canceled.
- (6) If the differential (the room temperature - the temperature setting) is "the differential $\geq 3\text{ }^{\circ}\text{C}$ " after powerful setting, the compressor's maximum speed during powerful operation will be set to SDMAX. Then the differential reduce "the differential $\cong 2.33\text{ }^{\circ}\text{C}$ " during powerful operation, the compressor's speed will be set to SDRPM.
If the differential (the room temperature - the temperature setting) is "the differential $< 3\text{ }^{\circ}\text{C}$ " after powerful setting, the compressor's minimum speed during powerful operation will be set to SDRPM.
- (7) After the powerful operation is ended, the system automatically operates with the previous settings used before the powerful operation.

Basic Heating Operation

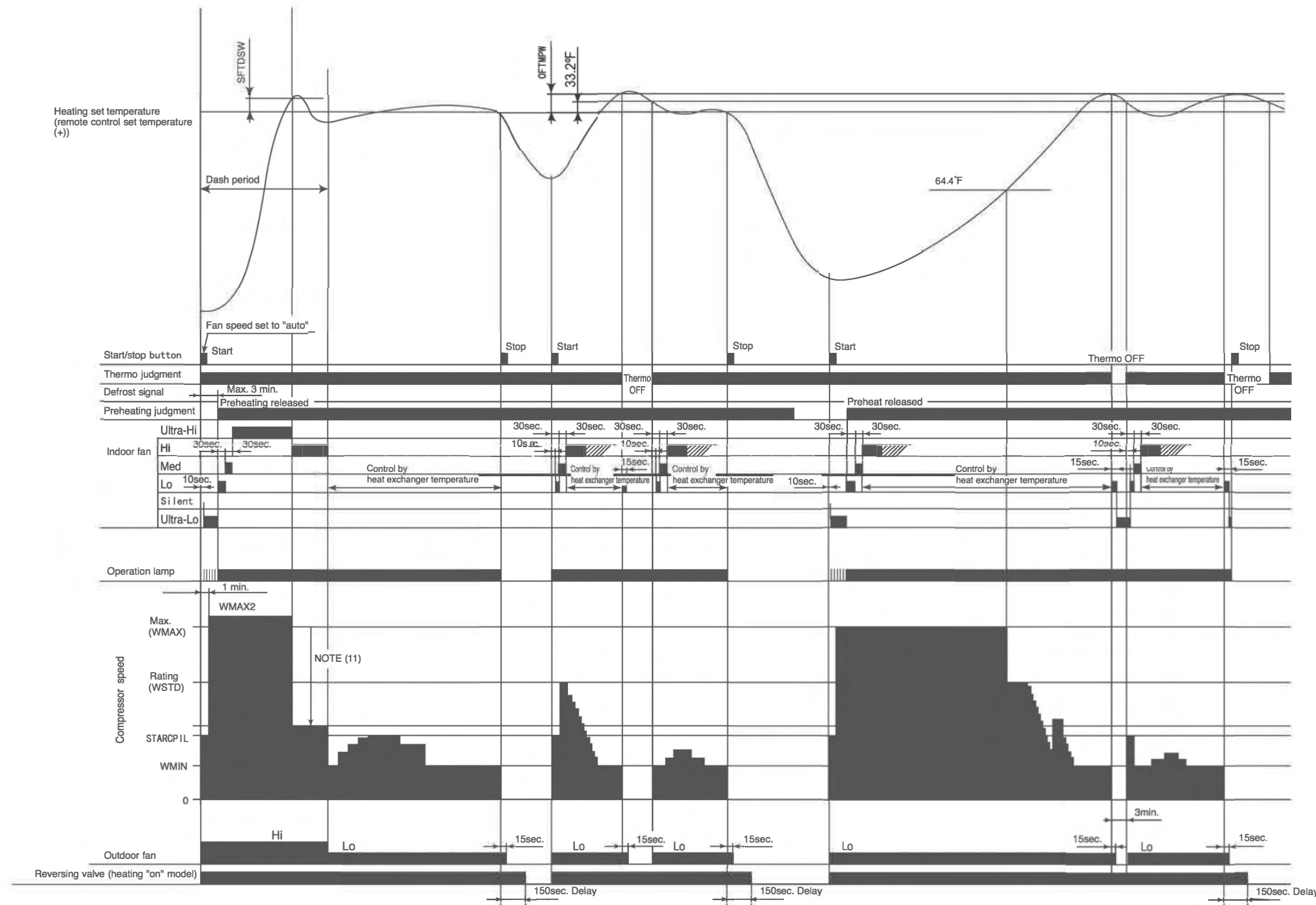

Notes:

- (1) Condition for entering into hot dashed mode. When fan set to "Hi" or "Auto" and i) room temperature is 64.4°F or less, and ii) outdoor temperature is 10 or less, and iii) compressor speed (P section) due to temperature difference between setting temperature(including shift value only) and room temperature is WMAX or more.
- (2) The maximum compressor speed period during hot dash is finished when i) room temperature has reached the setting temperature + SFTDSW. ii) thermo off.
- (3) During hot dashed operation, thermo off temperature is setting temperature (with shift value)+37.4°F. After thermo off, operation continue inn Fuzzy control mode.
- (4) Minimum "ON" time and minimum "OFF" time of compressor operation is 3 minutes.
- (5) During normal heating mode, compressor maximum rpm WMAX will maintain for 120 minutes. No time limit constrain if room temperature is 64.4°F or less and outdoor temperature is 35.6°F or less.
- (6) During preheating or defrosting or auto fresh defrosting mode, indoor unit operation lamp will blink at interval of 2 seconds "ON" and 1 second "OFF".
- (7) When heating starts, it will enter into preheating mode if indoor heat exchanger temperature is less than YNEOF + 32.6°F.
- (8) When fan is set to "Med" or "Lo" or "Silent", compressor rpm will be limited to "WJKMAX" or "WBEMAX" or "WSZMAX".
- (9) During "Ultra-Lo" mode, heat exchanger temp 64.4°F or less, indoor fan will stop. If hex temperature is 64.4°F +32.6°F or more, fan will continue in "Ultra-Lo" mode. However, "Ultra-Lo" mode during preheating or preheating after defrosting does not stop if room temperature is 64.4°F or less.
- (10) During hot dashed or outdoor temperature is -41°F or less, compressor rpm is WMAX2.
- (11) During hot dashed, when room temperature reaches setting temperature + SFTDSW compressor rpm is actual rpm x DWNRATEW.

Reversing valve defrosting

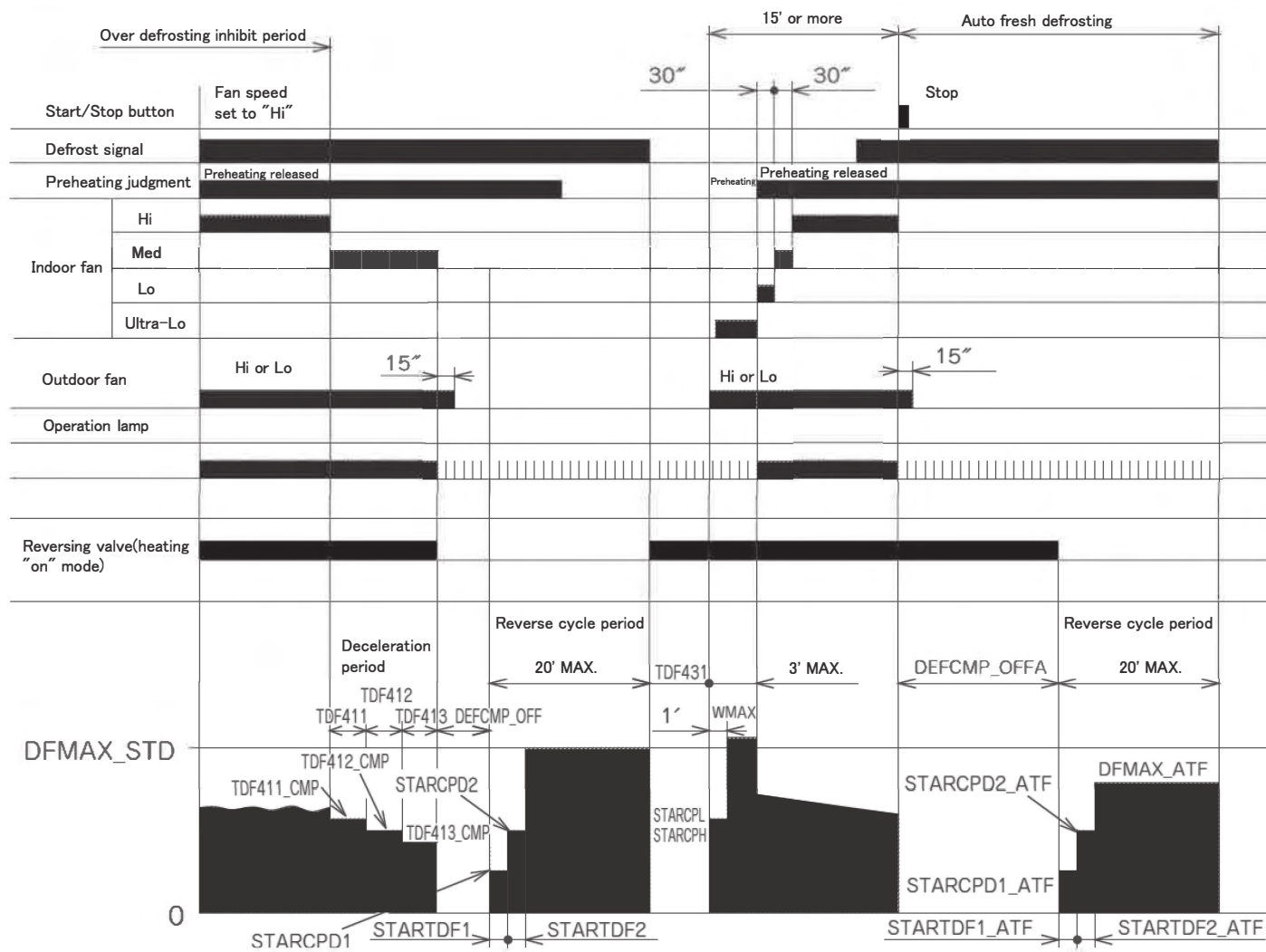

Notes:

- (1) The defrosting inhibit period is set as shown in the diagram below. When defrosting has finished once, the inhibit period is newly set, based on the outdoor temperature when the compressor was started. During this period, the defrost signal is not accepted.
- (2) If the difference between the room and outdoor temperature is large when defrosting is finished, the maximum compressor speed (WMAX) or (WMAX2) can be continued for 120 minutes maximum.
- (3) The defrosting period is 20 minutes maximum.
- (4) When operation is stopped during defrosting, it is switched to auto refresh defrosting.
- (5) Auto refresh defrosting cannot be engaged within 15 minutes after operation is started or defrosting is finished.

Setting Defrosting Inhibit Period

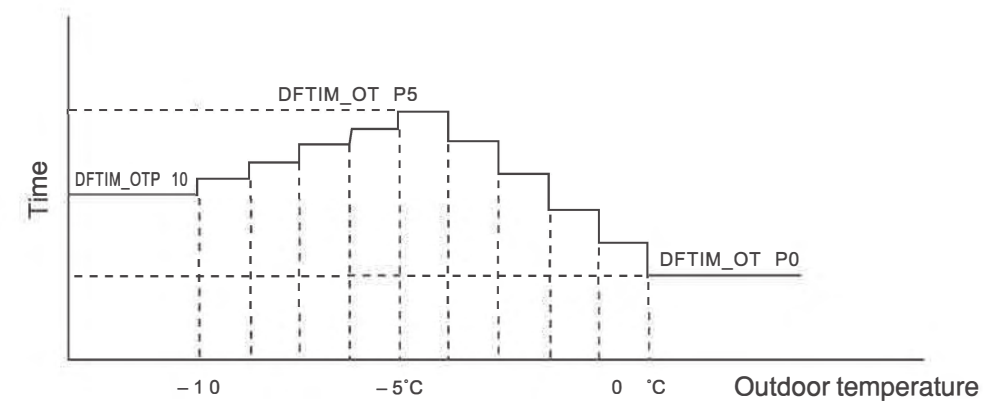

Notes:

- (1) The first inhibit time after operation start is set to DFTIM_FST.
- (2) From the second time onwards, the inhibit time is set according to the time required for defrosting.
 Reverse cycle operation time \geq [DEFCOL] : DEFTIM_COL is set.
 Reverse cycle operation time $<$ [DEFCOL] : The time corresponding to outdoor temperature is set.

Heating Powerful Operation

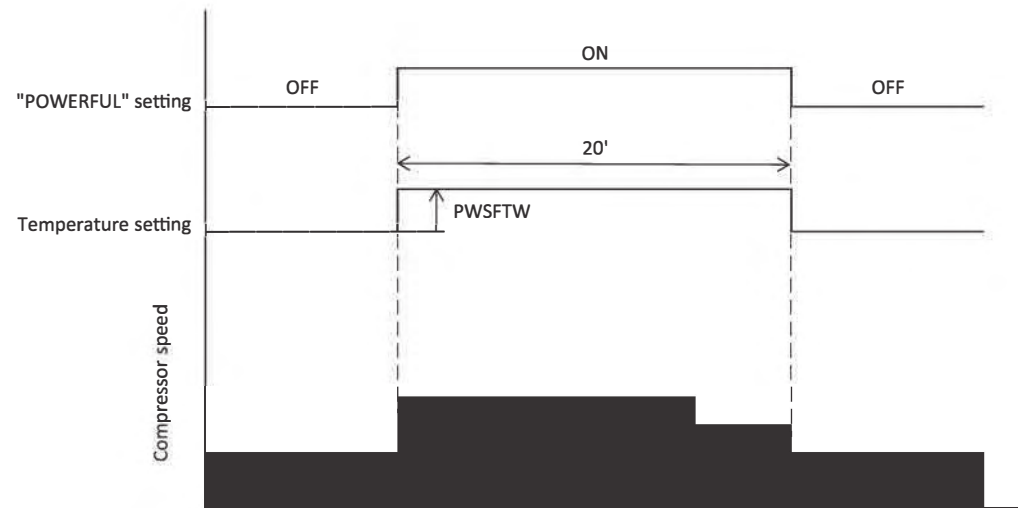

Notes :

- (1) Pressing the "POWERFUL" button will increase the temperature setting by PWSFTW.
- (2) The powerful operation is for 20 minutes after setting.
- (3) Operation is continued forcibly thermo-ON for 20 minutes after the powerful operation is finished.
- (4) Defrost is inhibited for 20 minutes after the start of the powerful operation.
- (5) Pressing the "START/STOP" button and "POWERFUL" button during powerful operation will cancel the powerful operation.
- (6) If the sleep timer is set during powerful operation, the powerful operation will be canceled.
- (7) When the powerful operation is set, the fan speed will be set to "HIGH" and the compressor's maximum speed will be set to WMAX2 during powerful operation. The compressor's lower limit speed is WKYMIN_PW.
- (8) After the powerful operation is ended, the system automatically operates with the previous settings used before the powerful operation.

Leave Home

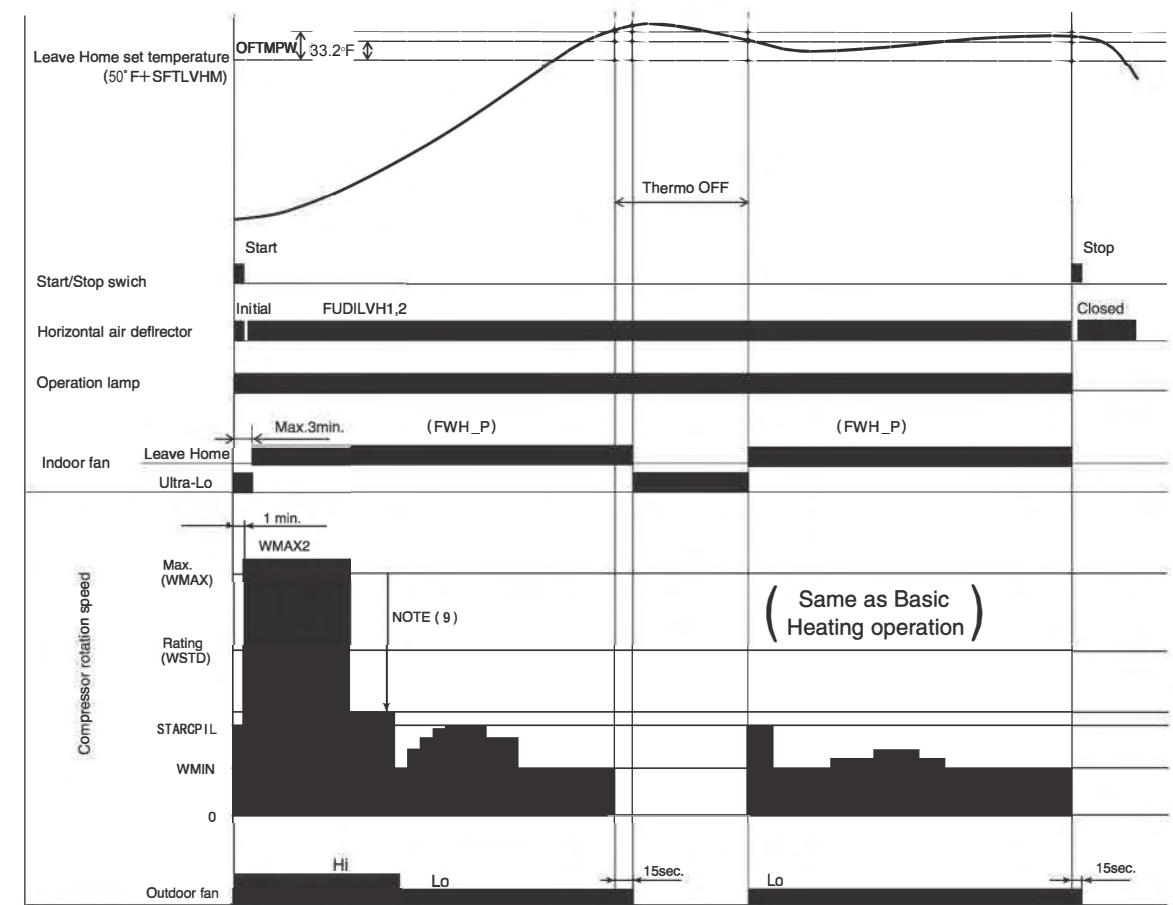

Notes:

Perform Leave Home operation according to the following control contents.

- (1) Operation mode : Heating
- (2) Setting temperature : 50°F
- (3) Shift value : + SFTLVHM
- (4) Indoor fan speed : FWH_P
- (5) Outdoor fan speed :
- (6) Compressor start control: } Same as Basic Heating operation
- (7) Compressor speed :
- (8) Operation lamp : ON

ECO Operation (With Motion Sensor)

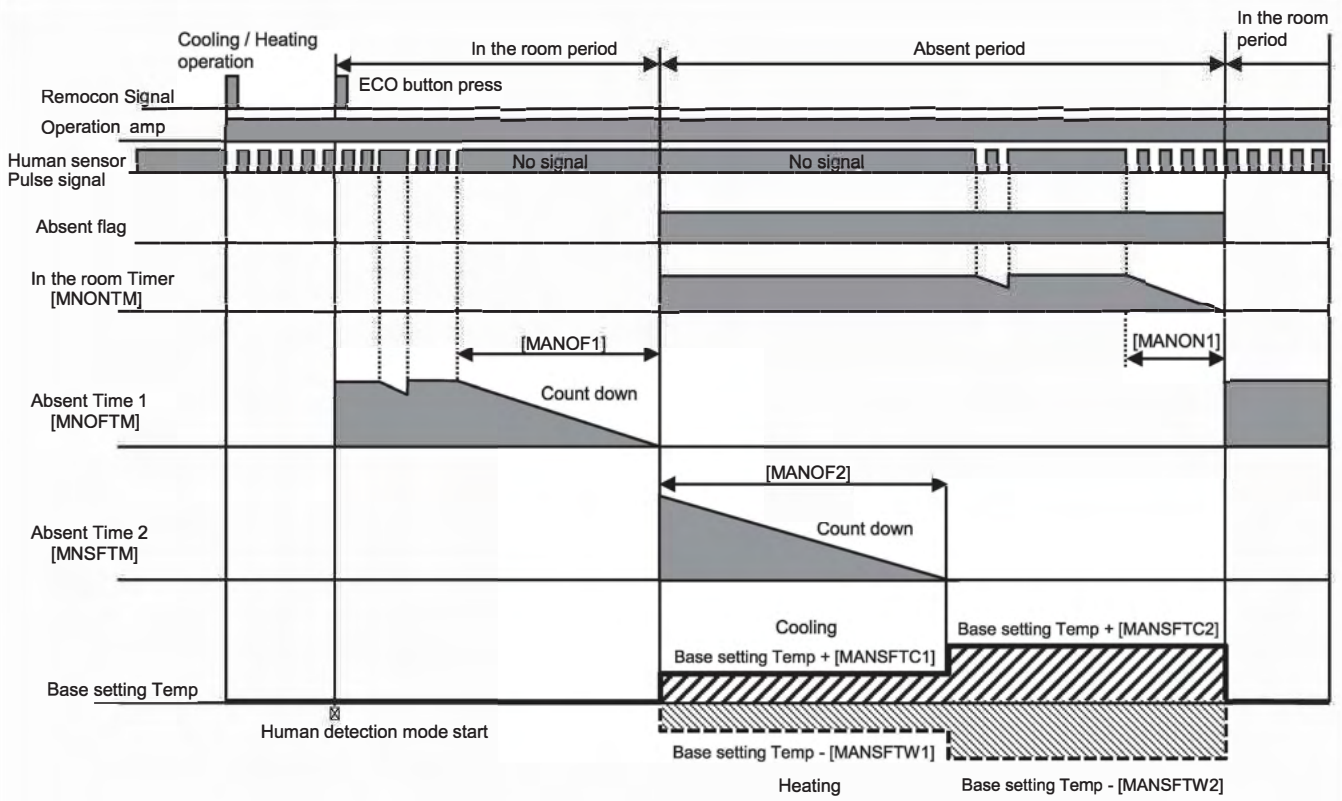

Notes :

1. ECO and POWERFUL cannot operate at the same time
2. ECO is not available during FAN operation.

Clean Operation

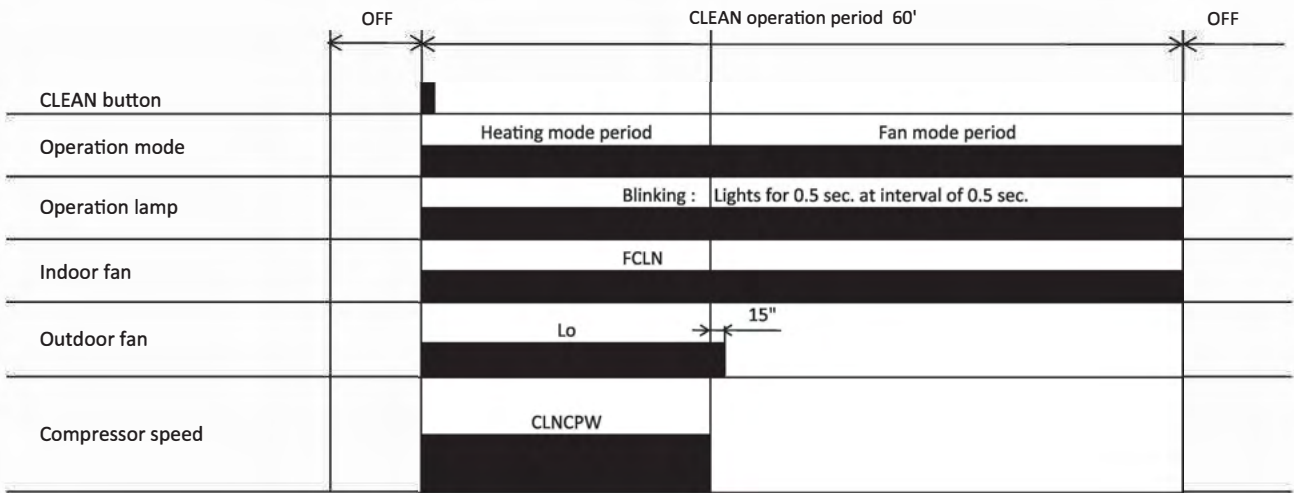

Notes :

- (1) During CLEAN operation period, heating mode will change to fan mode when HEX temperature is "CLNEVP" or more except for 3 minutes operation.
- (2) For multi connections, CLEAN operation is limited to fan mode.

Outdoor unit frost wash

Operates when the following conditions are met

- When the clean operation start time or the last stop time is reached during stop
- * It does not work at the time stopped by the off timer.

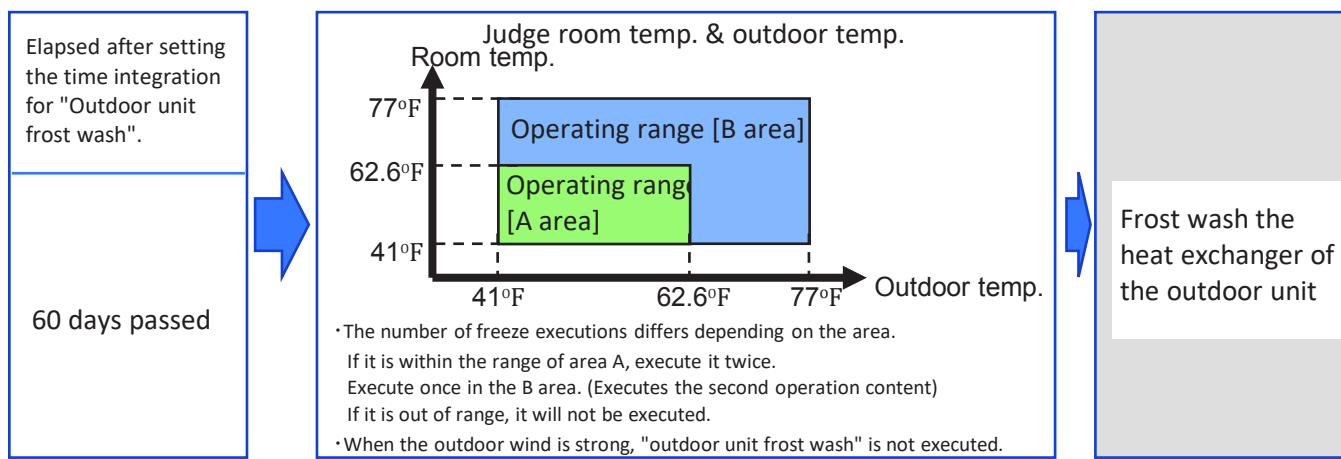

- Even if the start time is reached, the outdoor unit frost wash will not operate if the air conditioner is operating. It works at the same time the next day.
- * In addition to normal operation, indoor unit frost wash, auto fresh defrost, etc. are included during operation.
- When operating at the start time of clean operation, if the operation timing overlaps with the indoor unit frost wash, the outdoor unit frost wash will not operate.

- When operation for 10 minutes or more and stopping

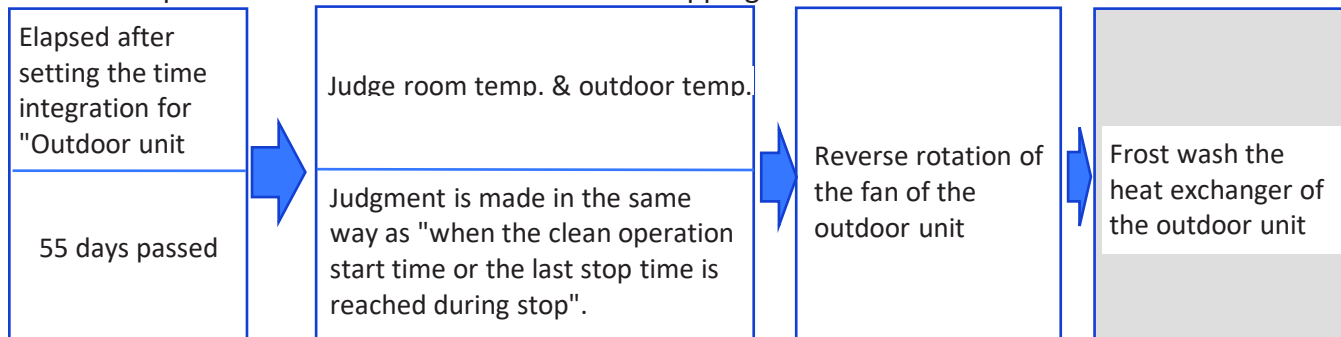

- If the operation is stopped by the off timer, the outdoor unit frost wash will not operate.
- If the operation timing overlaps with the frost wash of the indoor unit, the outdoor unit frost wash will not operate.

Control content

Time changes depending on temperature conditions

Control content	outdoor unit fan rotation stop waiting	Period to detect temp.	1st frost	1st defrost	2nd frost	2nd defrost	Dry
Time	1 min	3 min	15 min (Max)	3 min	10 min (Max)	3 min	30 min
Outdoor unit Fan	Stop	400min ⁻¹	100min ⁻¹	Stop	100min ⁻¹	Stop	500min ⁻¹
Compressor	Stop		Operation	Stop	Operation	Stop	
4 way Valve	Continue the previous operating state		Heating				
Indoor unit up-down flap	Close		Open				Close
Indoor unit Fan	Stop	450min ⁻¹	Operation	Stop	Operation	Stop	
FrostWash lamp	Off		Lighting				

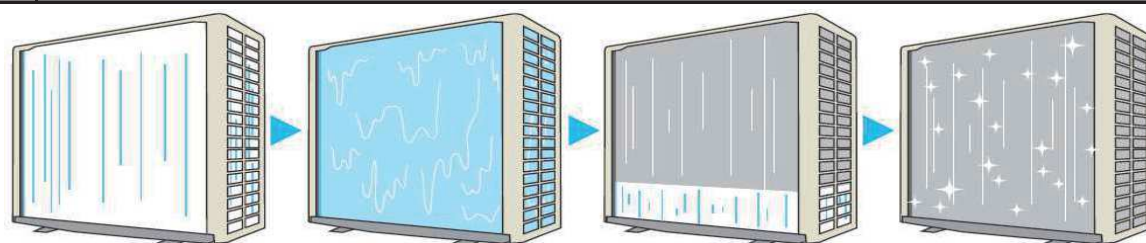

- If there is a function (auto fresh defrost / outdoor unit fan reverse rotation) that overlaps with the outdoor unit frost wash, it will wait until the end in the "waiting for outdoor unit fan rotation stop" period.
- If the pressure balance period is 3 minutes, wait until the end of the pressure balance time without proceeding from the "waiting for outdoor unit fan stop" period.
- The 1st frost, freezes the entire heat exchanger. For the 2nd frost, only freezes the lower part of the heat exchanger.

Prohibition conditions

- When the time until the on timer starts is within 120 minutes.

Integration time

- Counts the time since the outdoor unit frost wash was set.
- If you cancel the outdoor unit frost wash, it will be reset.
- Resets when the first freeze period begins.

Cancellation condition

- When the the outdoor unit frost wash is canceled.
(Does not interrupt during operation)

Conditions for early termination

- When operation is started.
- When the stop button is received.
- When the nature wind of outdoor is strong.

Freezing period end condition

Freezing will not end for 3 minutes from the start of freezing as forced operation.
(Stop signal is accepted)

Heat exchanger temperature maintenance conditions

Freezing ends when the heat exchange temperature during the freezing period can maintain the target heat exchange temperature for a certain period of time.

Room temperature rise conditions

To reduce discomfort, freeze is finished when the room temperature becomes high.

Combination of operation

The operation when the operation timing overlaps with other functions when the operation is stopped is as follows.

When it overlaps with Auto Fresh Defrost

Stop operation

Operation of indoor unit	Operation	Auto Fresh Defrost	Stop	Room temp. / outside temp. detection period	Frost wash the heat exchanger of the outdoor unit
Operation of outdoor unit	Operation	Fan stopped	Reverse rotation of the fan		
Operation lamp	Lighting	Blinking		Off	
FrostWash lamp		Off			Lighting

Outdoor unit frost wash by remote control operation

Hold down "Mode" and press "F.W/CL" on the remote control to start the outdoor unit frost wash.

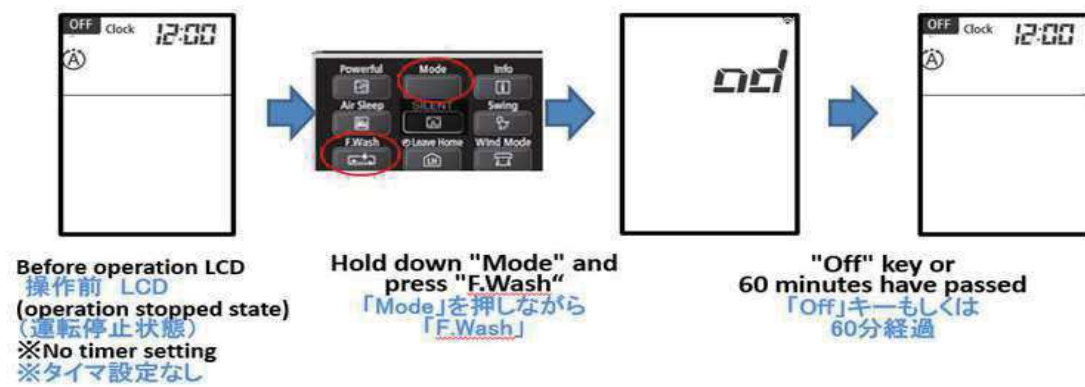

- In the following cases, it will not work.

The NG notification sound beeps and the cleaning lamp blinks for 10 seconds (1 second on / 1 second off).

* If the room temperature / outside temperature is not suitable for operation, or if the outdoor wind is strong, the cleaning lamp will turn off after about 4 minutes and the process will end.

- The air conditioner is operating.
- Indoor unit frost wash is starting. (Except during the Blower period)
- Outdoor unit frost wash operation is in progress.

Outdoor unit fan reverse rotation

It works when the outdoor unit frost wash is set.

Start condition

- If it operates for 10 minutes or more and stops, the reverse rotation will operate every time.
- It operates even if it is stopped by a timer.

Conditions for early termination

- When operation is started.
- When the stop button is received.
- When the outdoor wind is strong.

Cancellation condition

- When the the outdoor unit frost wash is canceled.
(Does not interrupt during operation)

Prohibition conditions

- After the ventilation operation is stopped.
- After the indoor unit frost wash is stopped.
- After the outdoor unit frost wash is stopped.

Control content

Operation of outdoor unit	Operation	Stop operation			
		Waiting for the forward rotation fan to stop	Reverse rotation	Waiting for the reverse rotation fan to stop	
Fan of outdoor unit	Positive rotation	Positive rotation (Delay)	Stop	Reverse rotation	Stop

When it overlaps with other operations

- If Auto Fresh Defrost operates, it will operate after Auto Fresh Defrost.
- When the automatic indoor unit frost wash or the outdoor unit frost wash operates, the reverse rotation operates before that.

REFRIGERATING CYCLE DIAGRAM

RAS-PH18PHLAE / RAC-PH18WHLAE

COOLING, DEHUMIDIFYING, DEFROSTING

OUTDOOR UNIT

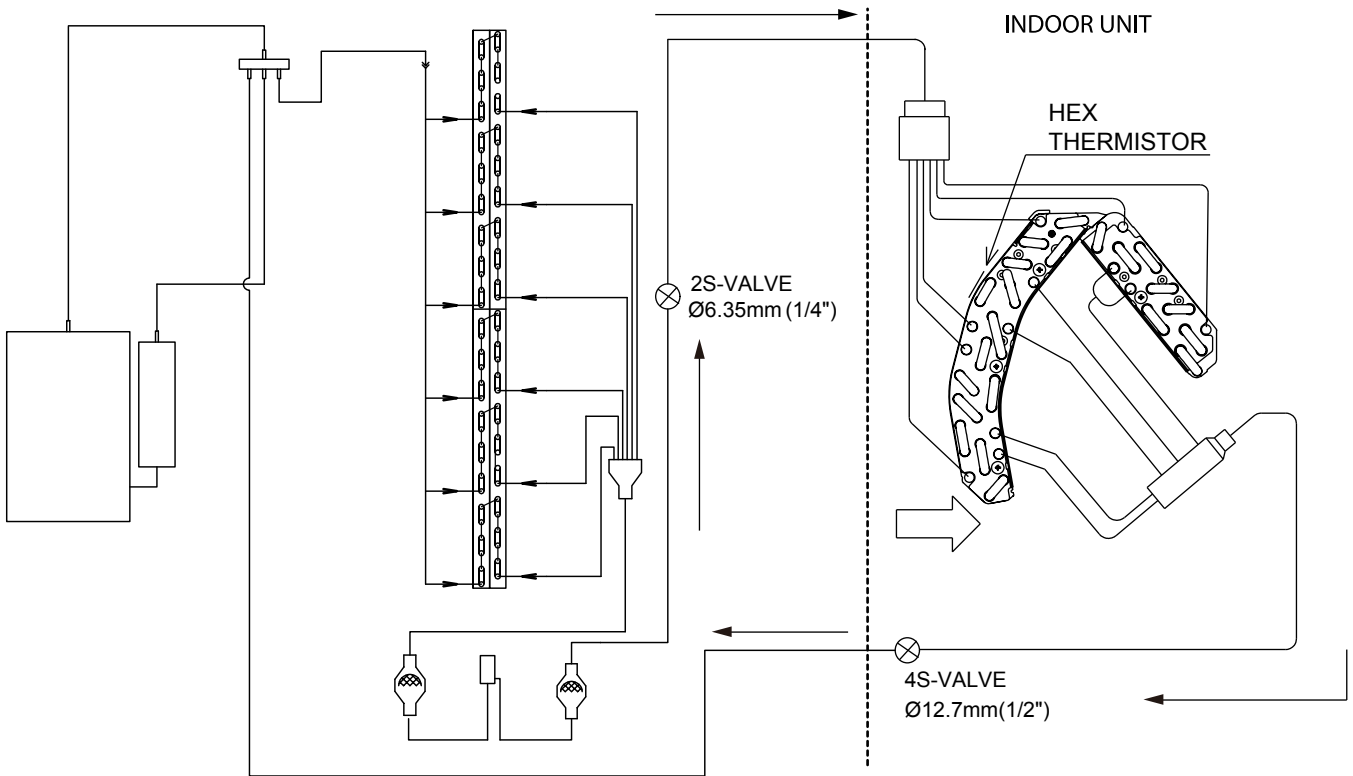

HEATING

OUTDOOR UNIT

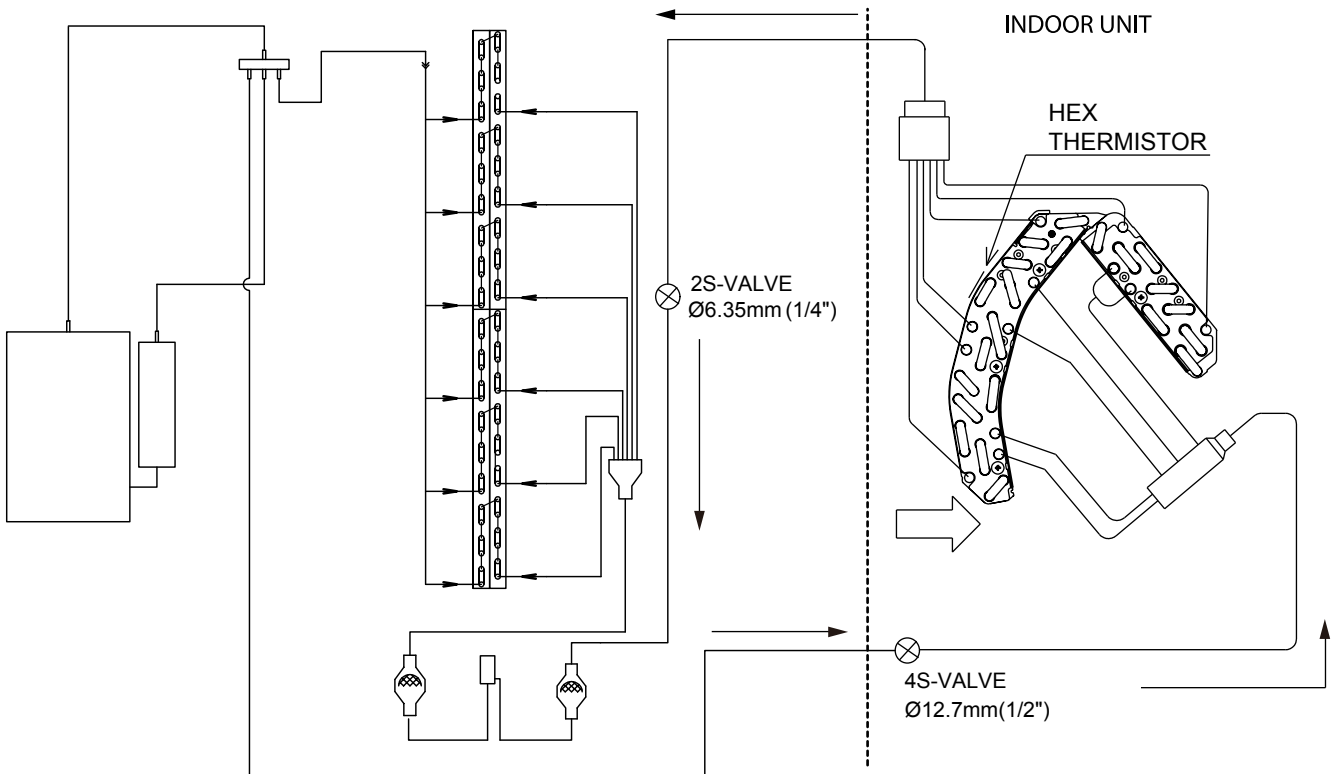

REFRIGERATING CYCLE DIAGRAM

RAS-PH24PHLAE / RAC-PH24WHLAE

COOLING, DEHUMIDIFYING, DEFROSTING

OUTDOOR UNIT

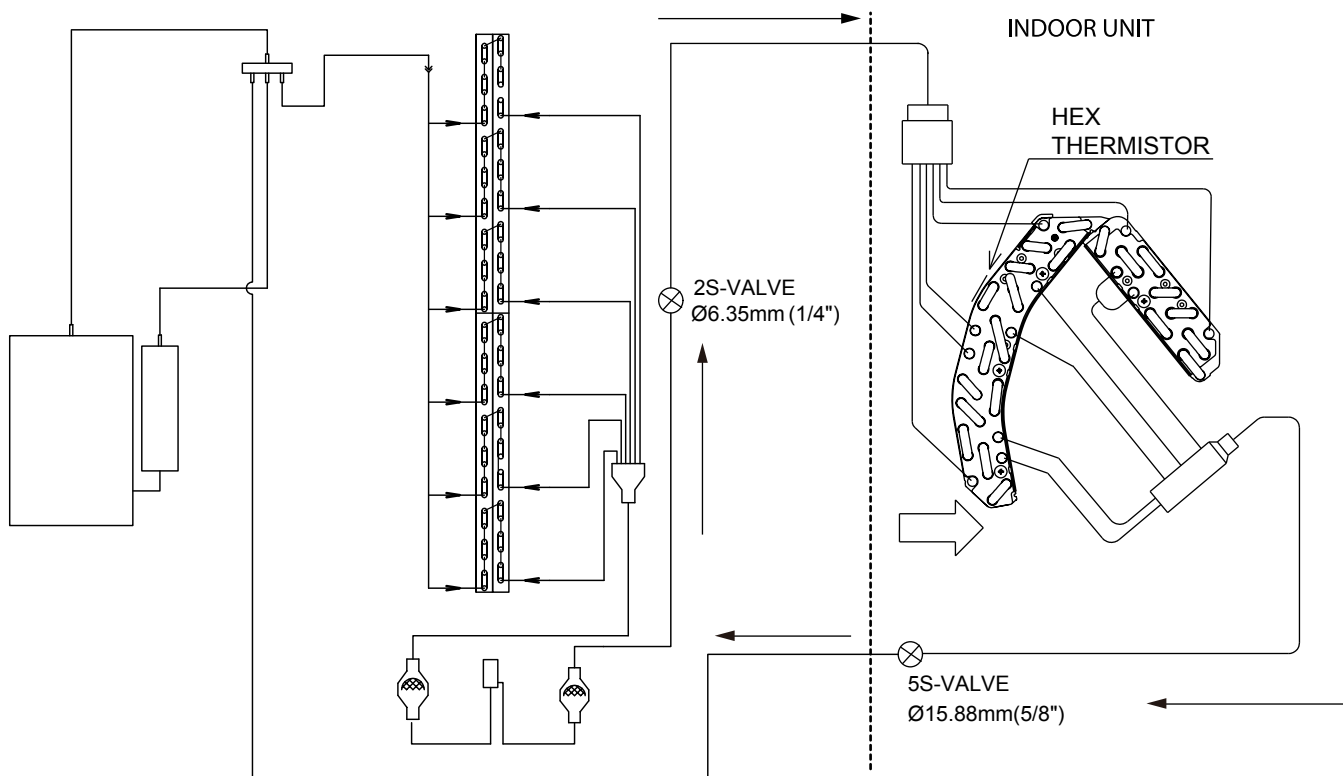

HEATING

OUTDOOR UNIT

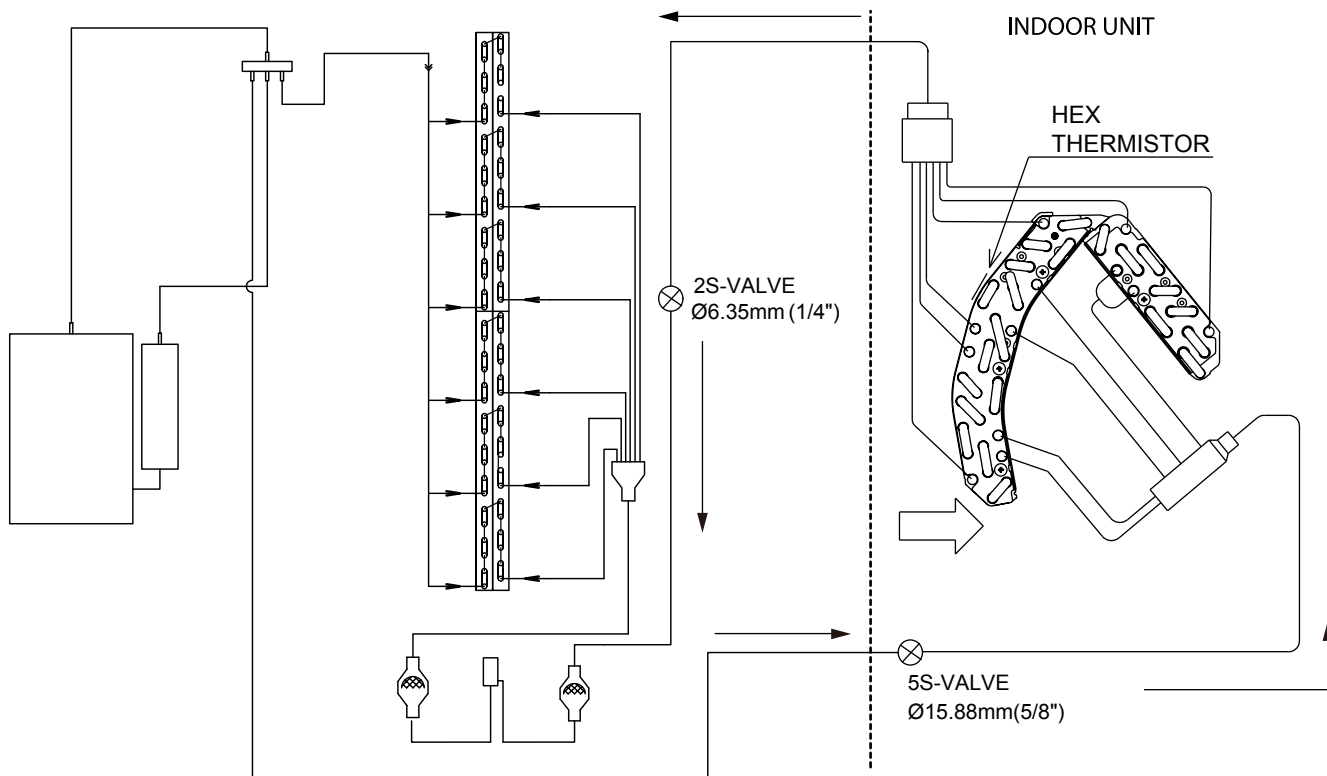

AUTO SWING FUNCTION

INPUT SIGNAL	PRESENT CONDITION			OPERATING SPECIFICATION	REFERENCE
	OPERATION	OPERATION MODE	AIR DEFLECTOR		
KEY INPUT	STOP	EACH MODE	STOP	ONE SWING (CLOSING AIR DEFLECTOR) ① DOWNWARD ② UPWARD	INITIALIZE AT NEXT OPERATION.
			DURING ONE SWING	STOP AT THE MOMENT.	
	DURING OPERATION	AUTO COOL COOL FAN DRY	STOP	START SWINGING ① DOWNWARD ② UPWARD ③ DOWNWARD	
			DURING SWINGING	STOP AT THE MOMENT.	
		AUTO HEAT HEAT	STOP	START SWINGING ① DOWNWARD ② UPWARD ③ DOWNWARD	
			DURING SWINGING	STOP AT THE MOMENT.	
THERMO. ON (INTERNAL FAN ON)	DURING OPERATION	DRY AUTO HEAT HEAT	TEMPORARY STOP	START SWING AGAIN.	
THERMO. ON (INTERNAL FAN OFF)			DURING SWINGING	STOP SWINGING TEMPORARILY. (SWING MODE IS CLEARED IF SWING COMMAND IS TRANSMITTED DURING TEMPORARY STOP.)	
MAIN SWITCH ON	STOP	COOL FAN DRY	STOP DURING ONE SWING	INITIALIZE ① DOWNWARD ② UPWARD	
		HEAT	STOP DURING ONE SWING	INITIALIZE ① DOWNWARD	
MAIN SWITCH OFF	DURING OPERATION	EACH MODE	STOP DURING SWINGING	ONE SWING (CLOSING AIR DEFLECTOR) ① DOWNWARD ② UPWARD	INITIALIZE AT NEXT OPERATION.
			DURING INITIALIZING		
CHANGE OF OPERATION	DURING OPERATION	EACH MODE	STOP	INITIALIZING CONDITION OF EACH MODE.	
			DURING SWINGING	STOP SWINGING AND MODE BECOMES INITIALIZING CONDITION.	

DESCRIPTION OF MAIN CIRCUIT OPERATION

MODEL RAS-PH18PHLAE, RAS-PH24PHLAE

1. Control power circuit

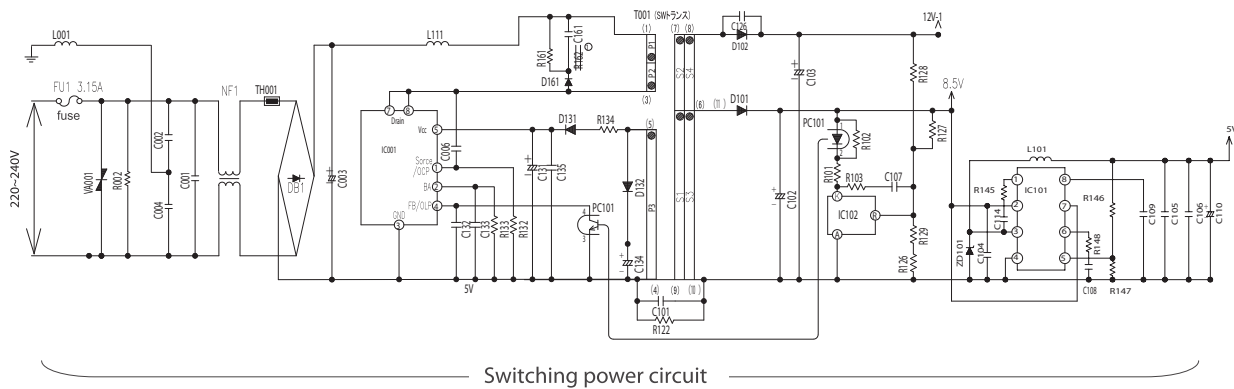

Fig.1-1

- An AC power supply from indoor unit passes through the 3.15A fuse, varistor (VA001), and noise filter circuit and rectified and smoothed by DB1 and C003 to become a DC current 325 V. It is then supplied to indoor fan motor drive circuit, and switching power circuit.
- The switching power circuit, as controlled by IC001, drives the primary winding of the transformer (T001) to produce a specified voltage at the output winding. [The output terminal (pin ⑤) of IC001 has a switching voltage. But it changes in voltage peak and oscillation period depending on the power load. usually, the oscillation frequency when the air condition operation is about 64.5 kHz. In the standby state, the oscillation frequency is lowered to a level as low as 64.5kHz or so to reduce the standby power.]
- The outputs of the output windings of the transformer is rectified and smoothed to become DC voltages at primary 18.5 V, 12 V, and 8.5 V respectively. The primary 18.5 V is supplied to the drive circuit of the indoor fan motor, the 12 V is supplied to each vane motor and to the drive circuits of the cleaning unit driving motor and other equipment, and the 8.5 V is adjusted to a stable 5 V by IC101 and supplied to the microcomputer peripheral circuit.

Check

If a failure in a part or circuit has produced an abnormal current in the power supply, the 3.15A fuse will melt down to prevent further damage. If the 3.15A fuse melts down, check the indoor fan motor, switching electrical circuit, and other components and replace any defective part.

Check

If an abnormally high voltage is applied to the power supply, the 3.15A fuse and varistor (VA001) will prevent further damage. If a high voltage results in the 3.15A fuse melted down, the varistor (VA001) should have deteriorated and destroyed. Therefore replace it at the same time.

Caution

The primary circuit of the transformer (T001) has a voltage to ground. Guard against electric shocks.

2. Reset Circuit

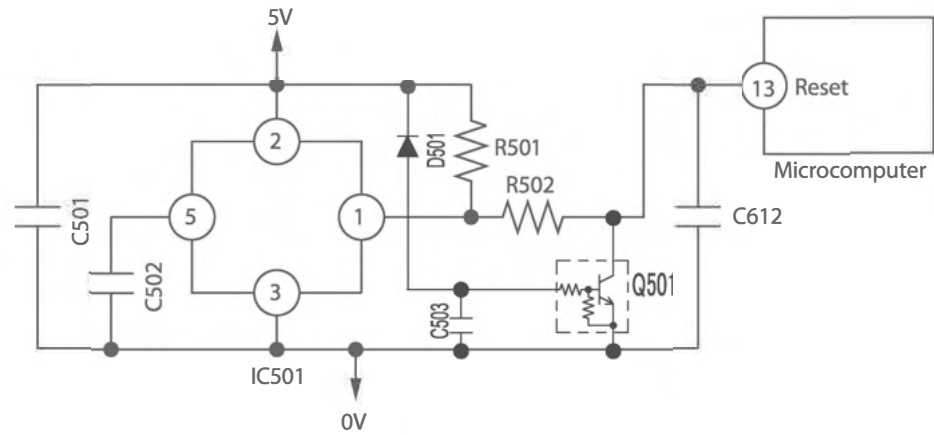

Fig. 2-1

Timing chart

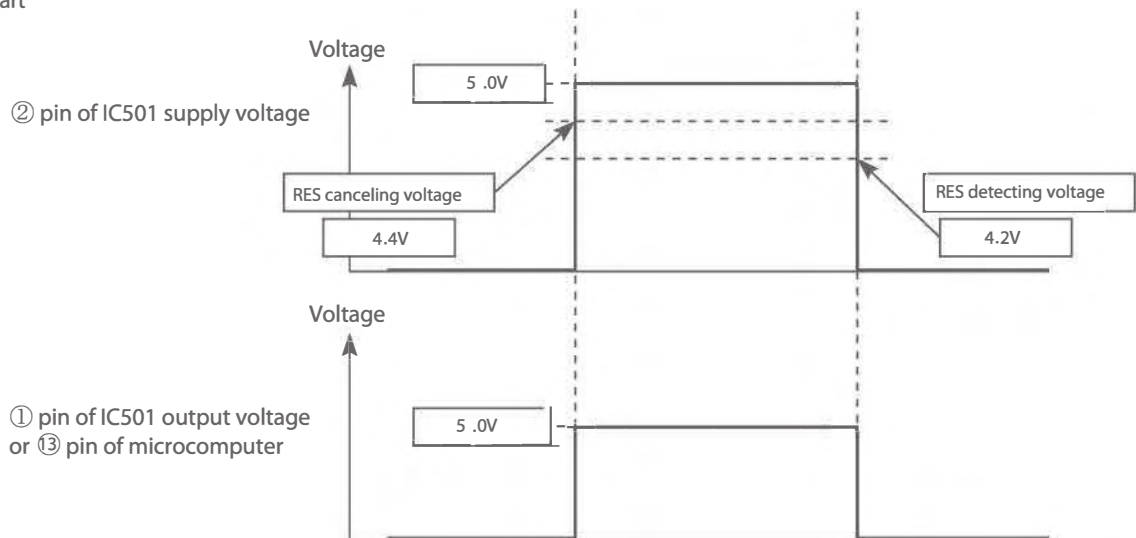

Fig. 2-2

- Reset circuit is to initialize the indoor unit microcomputer when switching ON the power or after recovering from power failure.
- Low voltage at pin ⑬ resets the microcomputer and Hi activates the microcomputer.
- Waveform of each part when switching ON the power and when shutting down is shown in the Fig. 3-2.
- After switching ON the power, ① pin of IC501 supply voltage and ⑬ pin of microcomputer becomes Hi when DC5V line rises and reaches approximately 4.4V or higher. Then, resetting will be cancelled and microcomputer starts operating.
- After shutting down the power, ① pin of IC501 supply voltage and ⑬ pin of microcomputer becomes Lo when DC5V line falls and reaches approximately 4.2V or lower. Then, the microcomputer will be in reset condition.

3. Drive circuit of the indoor fan motor

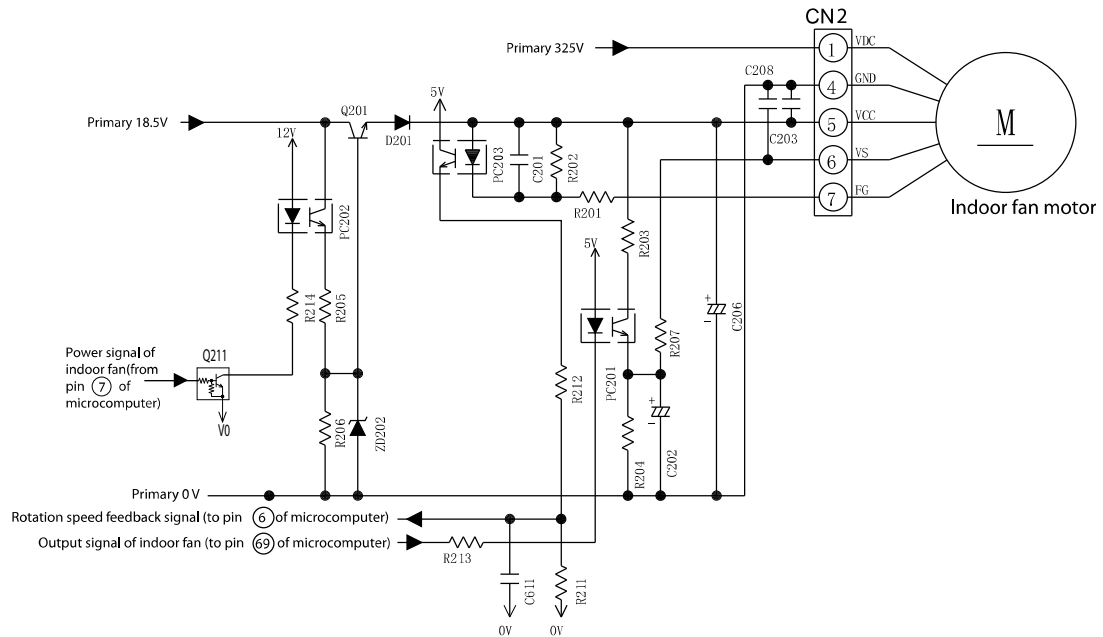

Fig. 3-1

< The circuit check (For test) >

Name	Test point	Test voltage
Motor drive power	CN2 ① pin- ④ pin	About 325V
Motor control power	CN2 ⑤ pin- ④ pin	About 15V
Motor speed signal	CN2 ⑥ pin- ④ pin	About 2-6V
Motor rotation speed debug	CN2 ⑦ pin- ④ pin	About 7.5V

- * The voltage above is all motor operation vol. when you start the test, take care of your connector, do not touch the different pin together.
- * The voltage of pin ⑥ - pin ④, pin ⑦ - ④ maybe different from above.

< Pin 6 - Pin 4 voltage one example >

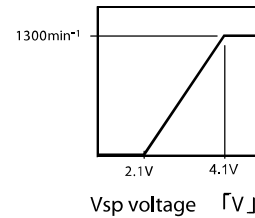

- * The different mode maybe have different FAN rotation speed.

< Typical circuit waveform >

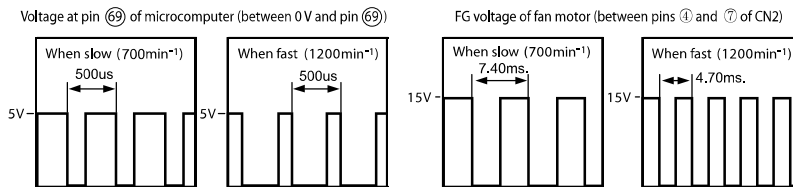

Fig. 3-2

- The indoor fan motor receives VDC (motor drive power supply), VCC (power supply for the control circuit inside the motor), and VS (speed command voltage) from CN2. The indoor fan motor returns an FG signal of a frequency that matches the rotation speed.
- VCC stabilizes the primary 18.5 V power supply into 15 V by using Q201 and supplies it.
- While on standby for a remote control signal, the Q201 shuts down the VCC and reduces the standby power.
- The VS receives a command voltage from the microcomputer. The VS terminal undergoes an analog voltage that matches the Lo level time ratio of the pulse signal from pin (69) of the microcomputer. (See Fig. 3-2.)
- The FG terminal undergoes a signal of 12 pulses per revolution of the motor shaft. By counting the pulse rate, the microcomputer recognizes the motor speed, thereby performing feedback control.

4. Buzzer Circuit

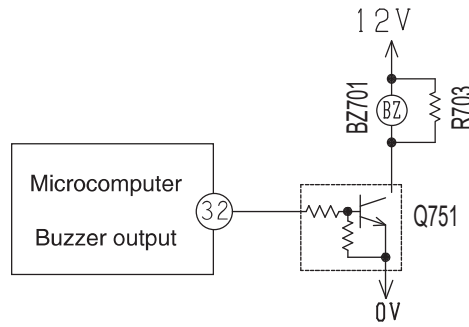

Fig.4-1 Buzzer Circuit

- When the buzzer sounds, an approx. 3.9kHz square signal is output from buzzer output pin (32) of the micro computer. After the amplitude of this signal has been set to 12Vp-p by a transistor, it is applied to the buzzer. The piezoelectric element in the buzzer oscillates to generate the buzzer's sound.

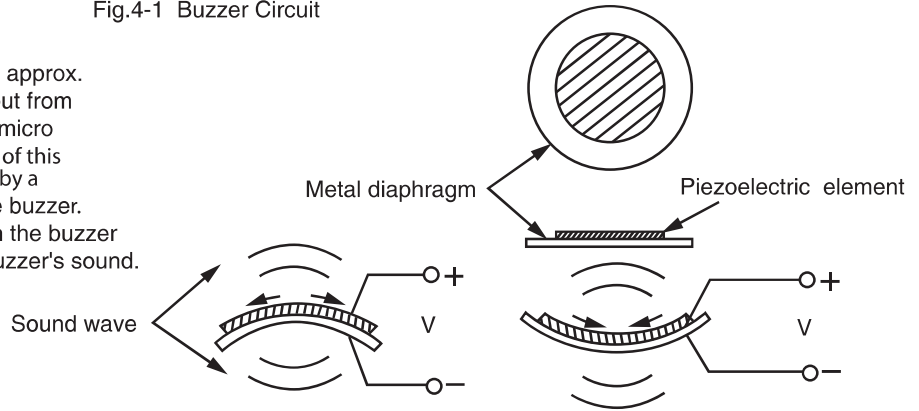

Fig.4-2 Buzzer Operation

5. Remote control reception circuit

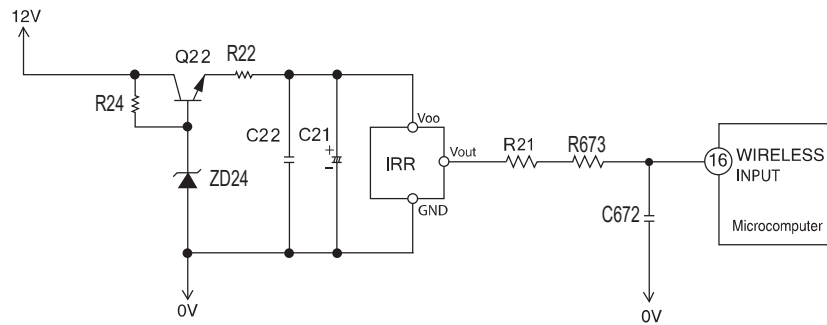

Fig.5-1

[Typical communication waveform]

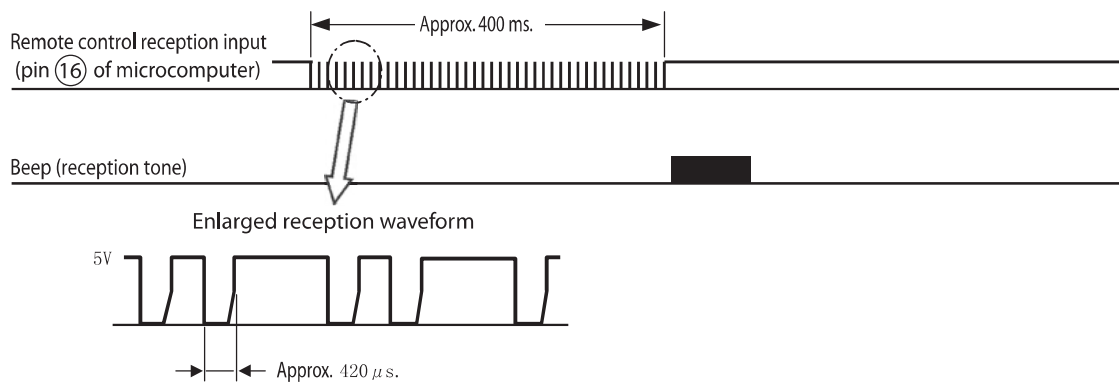
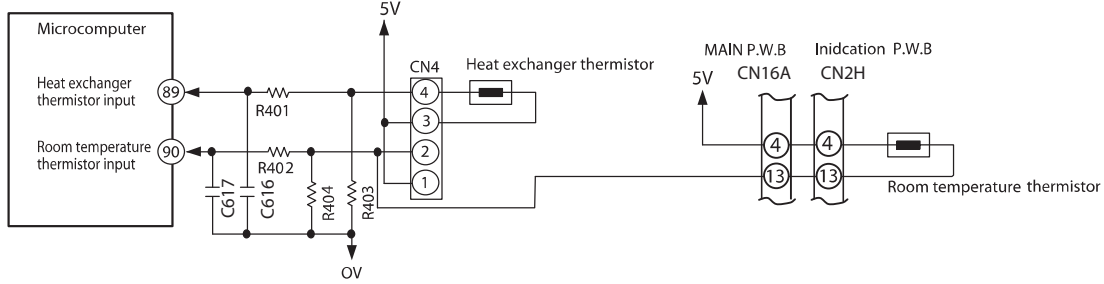

Fig.5-2

- An infrared signal from the remote control unit is converted to an electrical signal by the remote control light-receiving unit and is received by the microcomputer. Data is transmitted as digital data 0 and 1 by changing the interval of the basic pulses at about 420 μ s.

6. Room temperature, heat exchanger thermistor circuits



- The thermistor is used for detecting the room temperature and indoor unit heat exchanger pipe temperature.
- The thermistor is a sensor that changes its resistance value according to the temperature of the element and the microcomputer recognizes the analog voltage provided by the resistance voltage division with the fixed resistor as temperature signals.
- The relationship between the temperature of the thermistor and the circuit voltage is roughly as shown in Fig.6-1 and Fig.6-2. When it is easy to measure between the terminals of CN4 in actual measurement, use the graph of Fig. 6-3 "Thermistor both ends voltage".

"Thermistor both ends voltage".

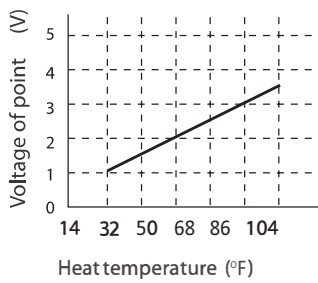

Fig. 6-1

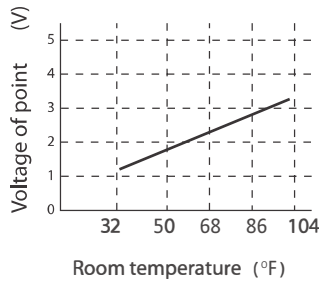

Fig. 6-2

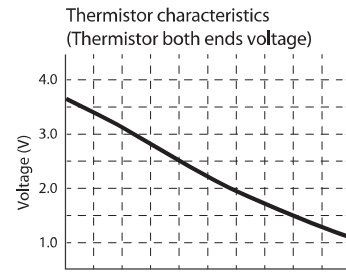

Fig. 6-3

7. Dip switch

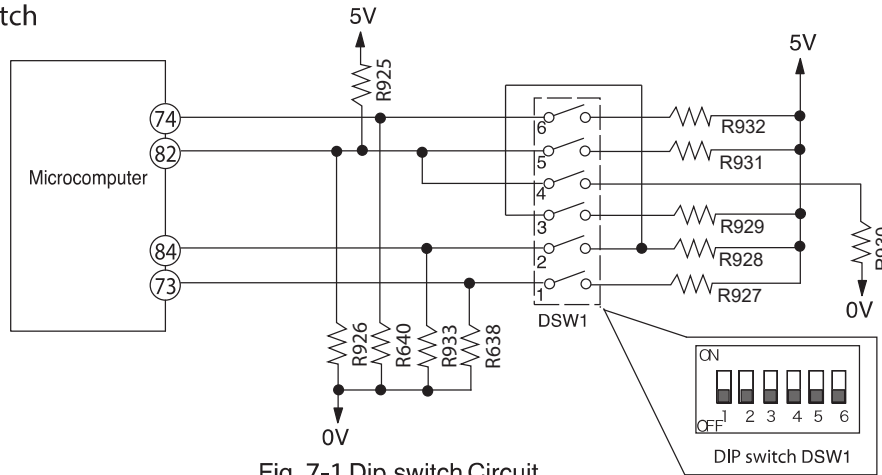

Fig. 7-1 Dip switch Circuit

- Fig. 7-1 shows the dip switch circuit; the table shown in Fig. 7-2 are function and setting position from ①-⑥ of the switch No.

SW No.	ITEM	FUNCTION			
1	AUTO RESTART	OFF*	ENABLE	ON	DISABLE
2	CARD KEY MODE	OFF*	DISABLE	ON	ENABLE
3	CARD KEY LOGIC SELECT	OFF*	INPUT HIGH ACTIVE	ON	INPUT LOW ACTIVE
4	HEATING/COOLING ONLY MODE SELECT	OFF*	HEATING & COOLING	OFF	HEATING ONLY
5	HEATING/COOLING ONLY MODE SELECT	OFF*		ON	
6	REMOCON ID SELECT	OFF*	FACTORY	ON	SELECT

Fig. 7-2 Functions of Dip switch

NOTE:

* Marking is position of shipping [FACTORY default setting]

8. Initial Setting Circuit (IC531)

- When power is supplied, the microcomputer reads the data in IC531 (E²PROM) and sets the preheating activation value and the rating and maximum speed of the compressor, etc. to their initial values.
- Data of self-diagnosis mode is stored in IC531; data will not be erased even when power is turned off.

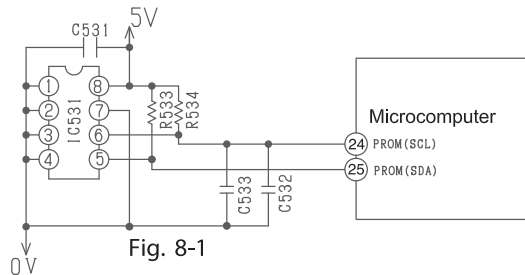

9. Temporary Switch Circuit

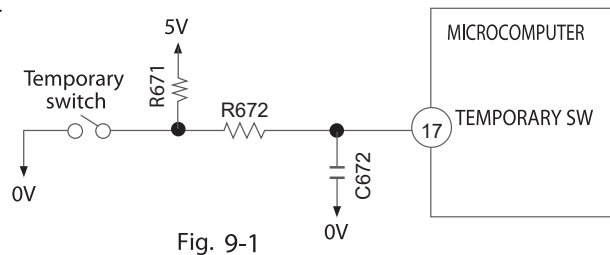

- The temporary switch is used to operate the air conditioner temporarily when the wireless remote control is lost or faulty.
- The air conditioner operates in the automatic mode by pressing the temporary switch. If the power switch is set to OFF then ON it also operates in the automatic mode when the temporary switch is pressed.

10. Infrared human presence sensor circuit

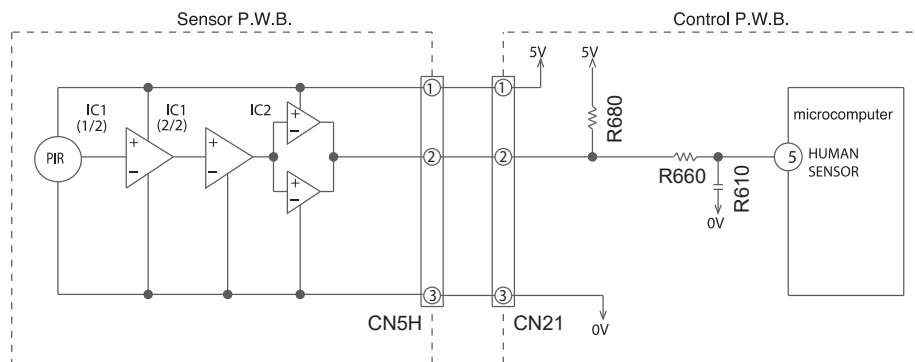

Fig.10-1

- With the infrared sensor, the air conditioner can detect the activity level in a room and adjust the temperature and humidity automatically, thus achieving the purpose of energy saving.
- When the activity level in a room is detected, the infrared sensor will be in operation. And a low-voltage output from the infrared sensor P.W.B. will be magnified by the amplifier comparator and be transformed the digital signal to microcomputer (IC601).

Infrared sensor

The infrared sensor output is [Hi] when the activity level is not detected. On the contrary, output is [Lo].

The area in front of the indoor unit is divided into 3 parts (the left area, central area and right area). According to the 3 areas, the infrared sensor detects the position of people.

The left-hand chart is displaying the operation of the infrared sensor when detecting the person moving from the left area to the right.

11 . Indoor/outdoor communication circuits

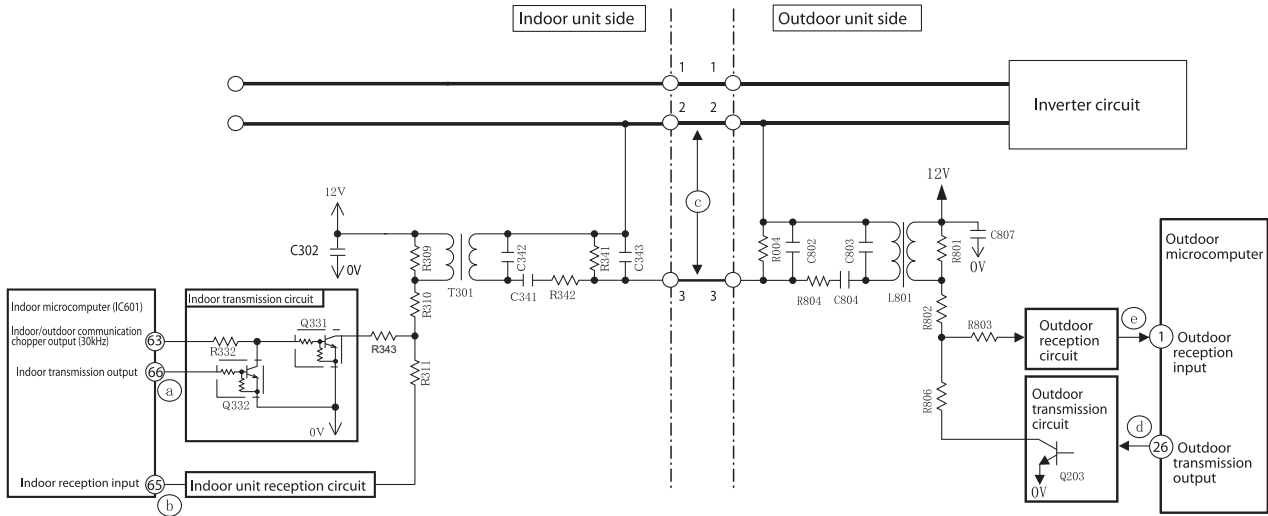

Fig. 11 -1

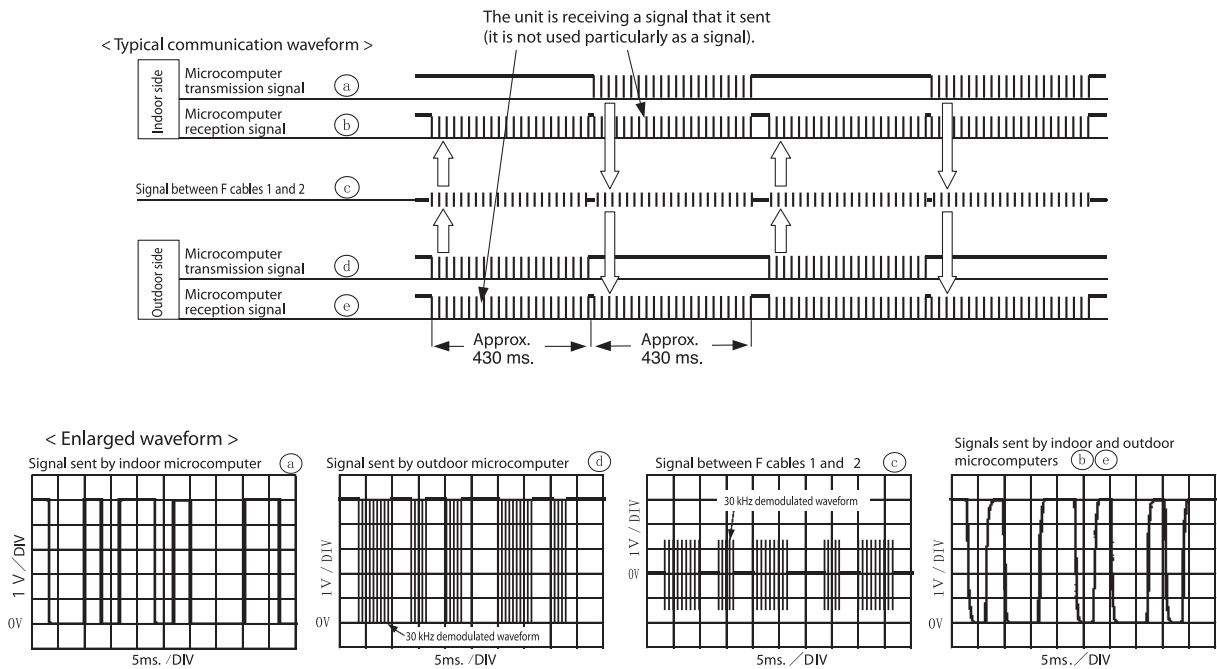

Fig. 11 -2

- Indoor and outdoor communications are conducted by using lines 2 and 3 of F cable. Line 2 of F cable is shared with a transmission channel that powers the outdoor unit.
- Data communicated between the indoor and outdoor units are outputted from the microcomputer as serial signals and are transmitted as demodulated by a 30 kHz carrier wave. (Both the indoor and outdoor microcomputers directly output a signal demodulated at 30 kHz.)

Check

If a cable poorly inserted in the indoor terminal board or some other failure overheats the terminal board and the temperature fuse of the terminal board blows out, the power to the indoor communication circuit will be shut down to stop the communications function.

Check

If communication fails between the indoor and outdoor units for some reason, the product will give a self-diagnosis display either by "the timer lamp blinking 3 times" or "the timer lamp blinking 12 times" depending on the cause.

Indoor/Outdoor communication fault circuit judgement

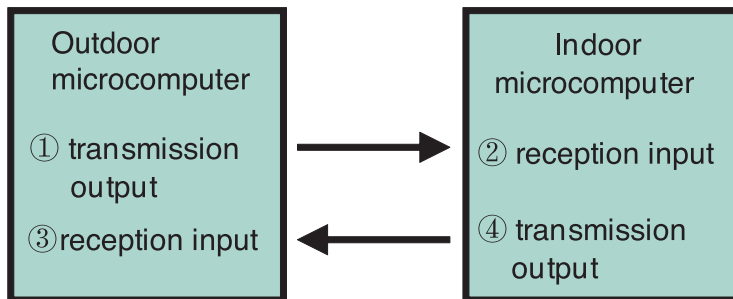

1. Failure happen during unit running

- 【If ① failure】 Outdoor: LD301 blinking 9 times / Indoor: no failure display
- 【If ② failure】 Outdoor: LD301 blinking 9 times / Indoor: the timer lamp blinking 3 times
- 【If ③ failure】 Outdoor: LD301 blinking 9 times / Indoor: no failure display
- 【If ④ failure】 Outdoor: LD301 blinking 9 times / Indoor: the timer lamp blinking 3 times

2. Failure happen during standby mode but outdoor unit not yet enter hibernation mode

- 【If ① failure】 Outdoor: LD301 blinking 9 times / Indoor: the timer lamp blinking 12 times
- 【If ② failure】 Outdoor: LD301 blinking 9 times / Indoor: the timer lamp blinking 3 times
- 【If ③ failure】 Outdoor: LD301 blinking 9 times / Indoor: the timer lamp blinking 12 times
- 【If ④ failure】 Outdoor: LD301 blinking 9 times / Indoor: the timer lamp blinking 3 times

3. Failure happen during standby mode but outdoor unit already enter hibernation mode

- 【If ① failure】 Outdoor: no failure display / Indoor: the timer lamp blinking 12 times
- 【If ② failure】 Outdoor: no failure display / Indoor: the timer lamp blinking 3 times
- 【If ③ failure】 Outdoor: no failure display / Indoor: the timer lamp blinking 12 times
- 【If ④ failure】 Outdoor: no failure display / Indoor: the timer lamp blinking 3 times

When outdoor unit is in hibernation mode, outdoor microcomputer is off, so the outdoor unit can't display the failure.

12. Stepping motor drive circuit

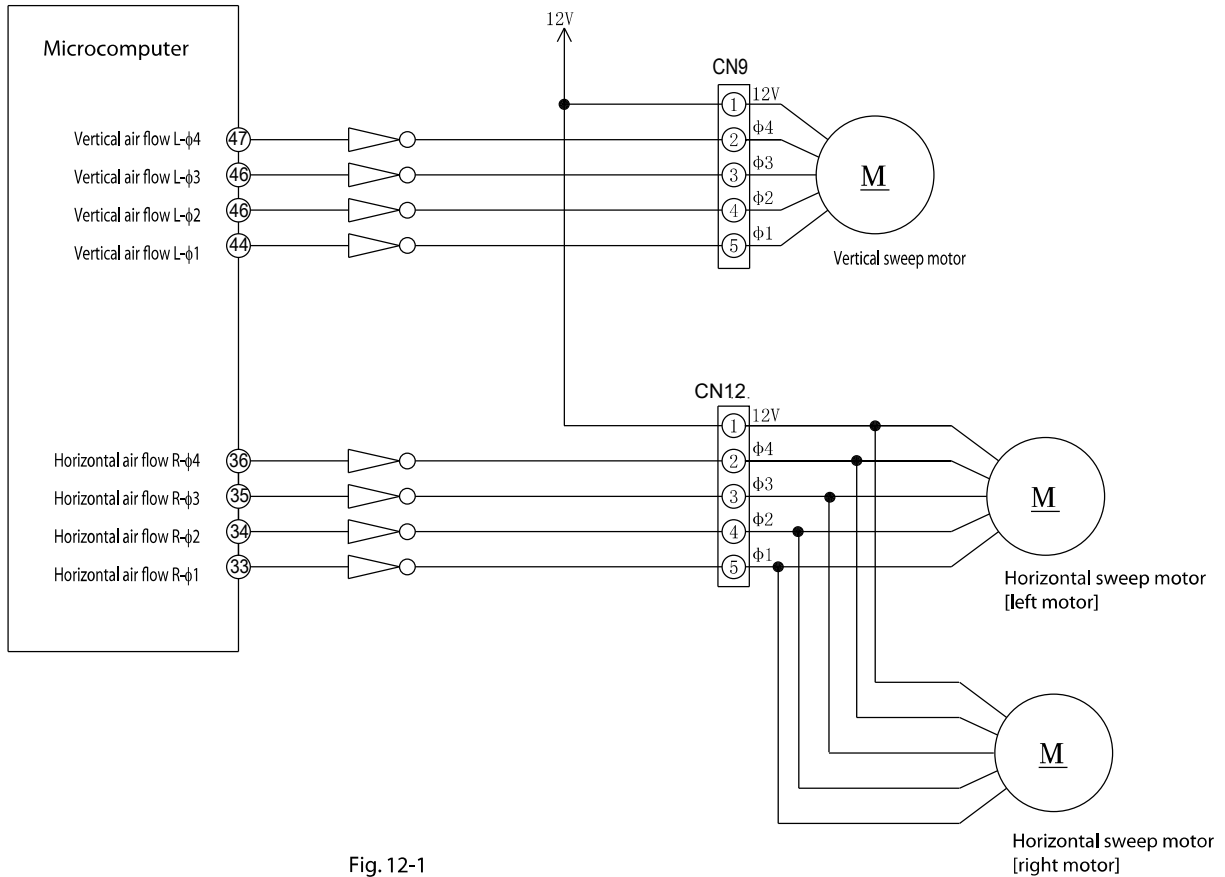

Fig. 12-1

[Connector circuit waveform while the motor runs]
 Voltage waveforms of different phases as viewed from the OV line while the motor rotor is turning counterclockwise as viewed from the shaft side

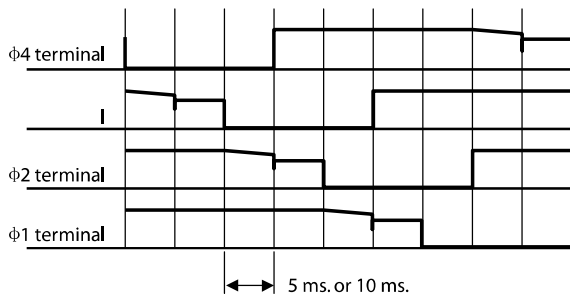

Fig. 12-2

- Each stepping motor runs as excited in 1 or 2 phases at 100 PPS or 200 PPS.
- The excitation pattern passes the microcomputer (IC601) and then the driver IC and excites the coil of each stepping motor.
- Some models not need to install the horizontal sweep motor.

13. Run status and alarm signal output circuit

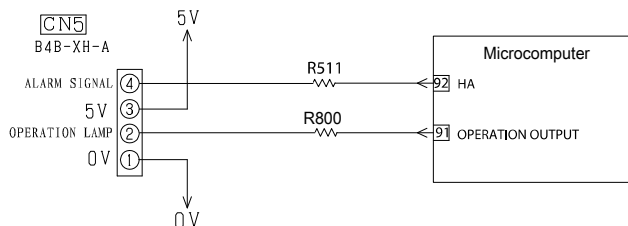

Fig.13-1

Fig.13-1 is the control circuit of run status and signal output in main PWB. The pin ② of CN5 is used to show run status and the pin ④ of CN5 is used to warn people when failure occurrence. If customer want to use this function, need to use the adapter (sold separately) to achieve it. the adapter is optional and the detail circuit refer to following circuit.

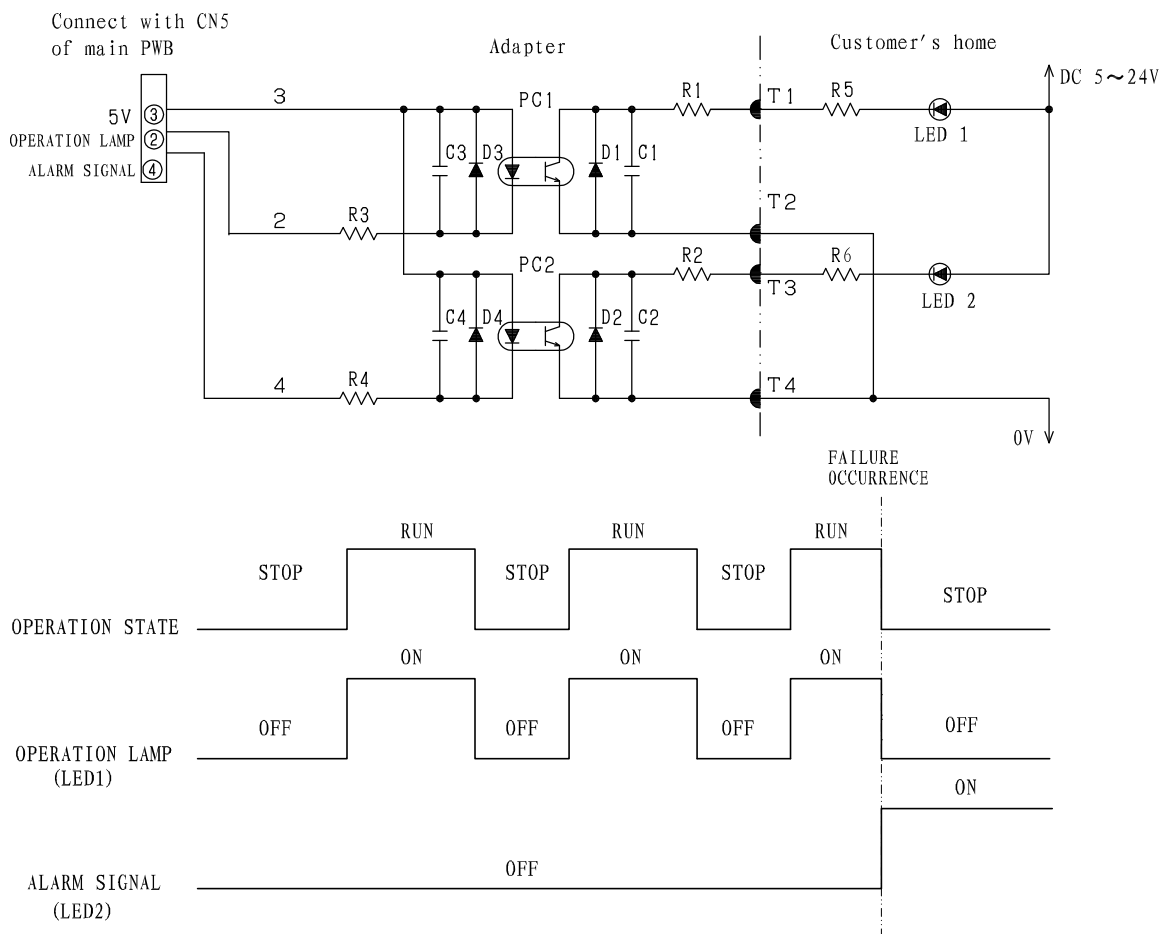

Fig.13-2

LED1 is on When air-condition is running and is off When air-condition is stopping. We can know the status of air-condition by LED1. LED2 is off When air-condition in normal condition and is on when air-condition in failure occurrence, we can repair it in time. The brightness of the lamp (LED1, LED2) can be determined by adjusting the resistance (R5, R6) value.

※ The adapter must be used because of noise interference. The noise will cause air-condition failure. the voltage from customer's home supply to adapter must be in the 5~24V, the current is less than 10mA. If the voltage is lower than 5V, optocouplers will not be action; once the voltage is higher than 24 V, optocouplers adapter will be damaged.

14. Humidity sensor circuit

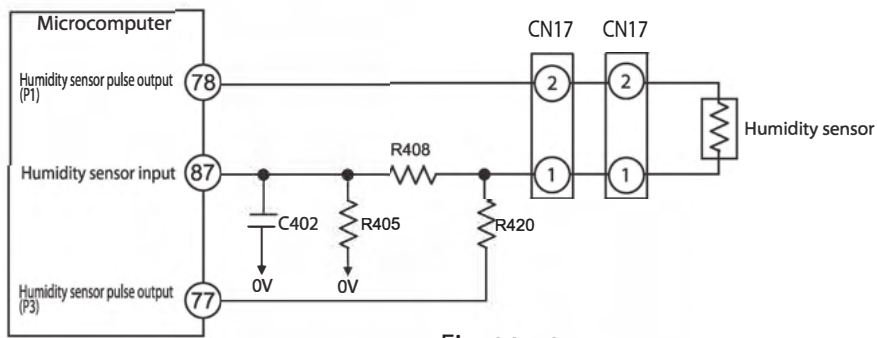

Fig. 14-1

- The humidity sensor changes to a resistance value, according to the ambient relative humidity. The voltage division with R420 thereby changes and the microcomputer (IC601) recognizes the humidity according to voltage signals.

DESCRIPTION OF MAIN CIRCUIT OPERATION

MODEL RAC-PH18WHLAE, RAC-PH24WHLAE

1. Power Circuit

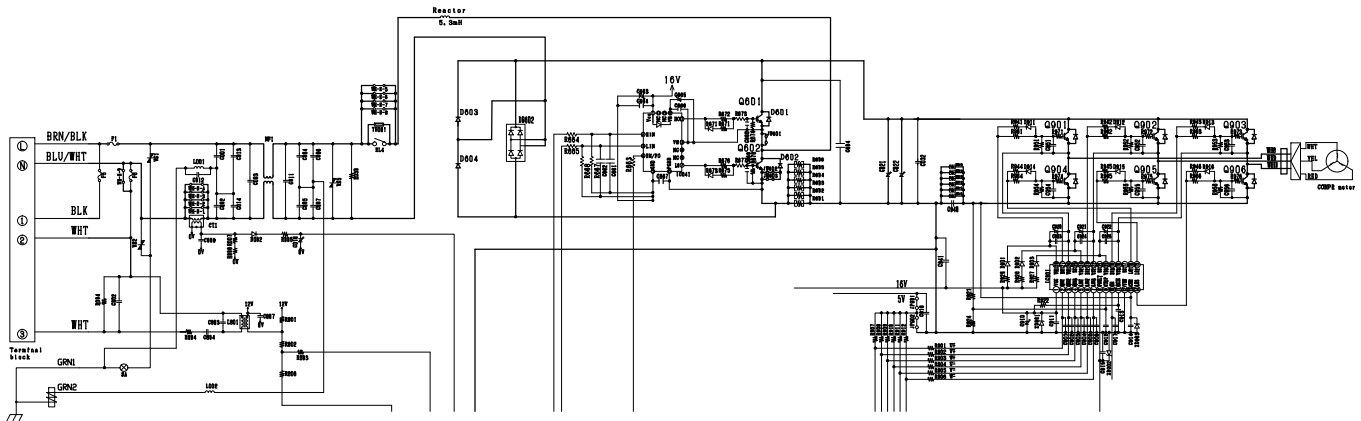

Fig 1-1

※ This circuit full-wave rectifies 230VAC applied between terminals L and N and boosts it to a required voltage with the IGBTs to create a DC voltage.

The voltage become 300-330V when the compressor is operated.

※ Importance component

(1) Intelligence Power Module

A module that constitute by an inverter part.

(2) Diode Stack (DB602)

These rectify the 230VAC from terminal L and N to a DC power supply.

<Reference>

※ In case of Intelligence Power Module malfunction or connection failure immediately after compressor starts, its may stop due to error of [abnormal low speed], [switching failure],[Ip stop] and others.

<Reference>

※ If diode stack (DB602) are faulty, DC voltage may not be generated and the compressor may not operate at all. Also be aware that the 25A fuse might have blown.

(3) Smoothing capacitors (C021-C022, 610 μ F, 450V)

This smoothes (averages) the voltage rectified by the diode stack.

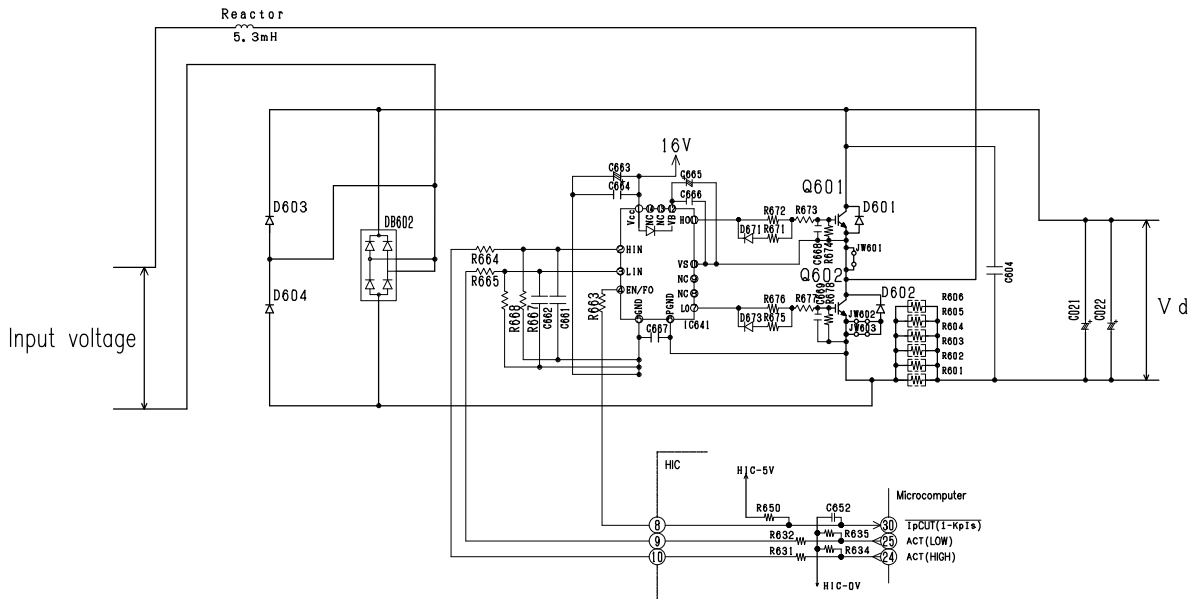

Fig. 1-2

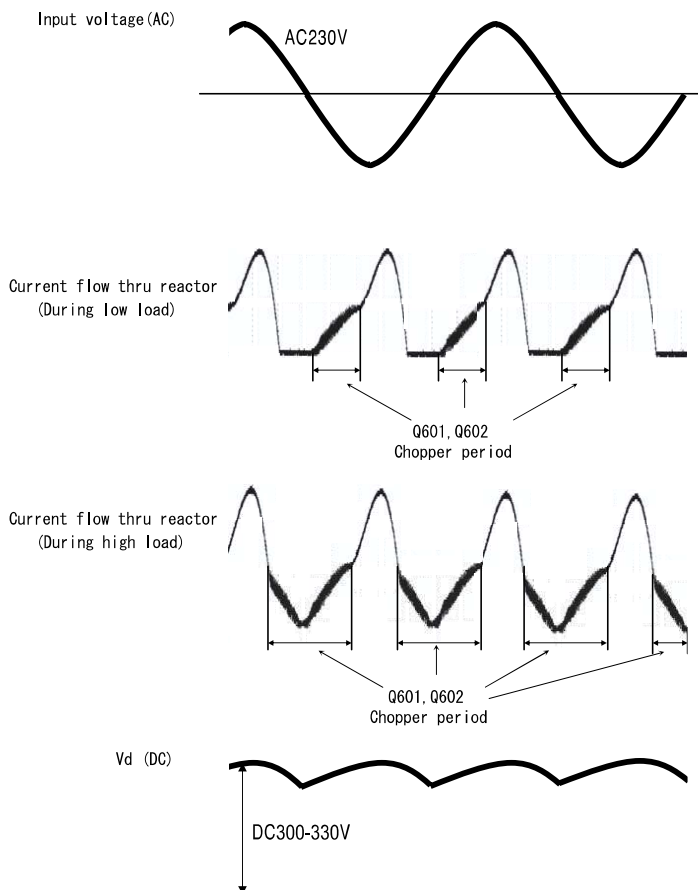

Fig. 1-3

(4) IGBT to improve efficiency (Q601, Q602)

It will improve the efficiency during compressor load become heavy when current flow thru the chopper period of Q601, Q602.

2. Power circuit (Low voltage)

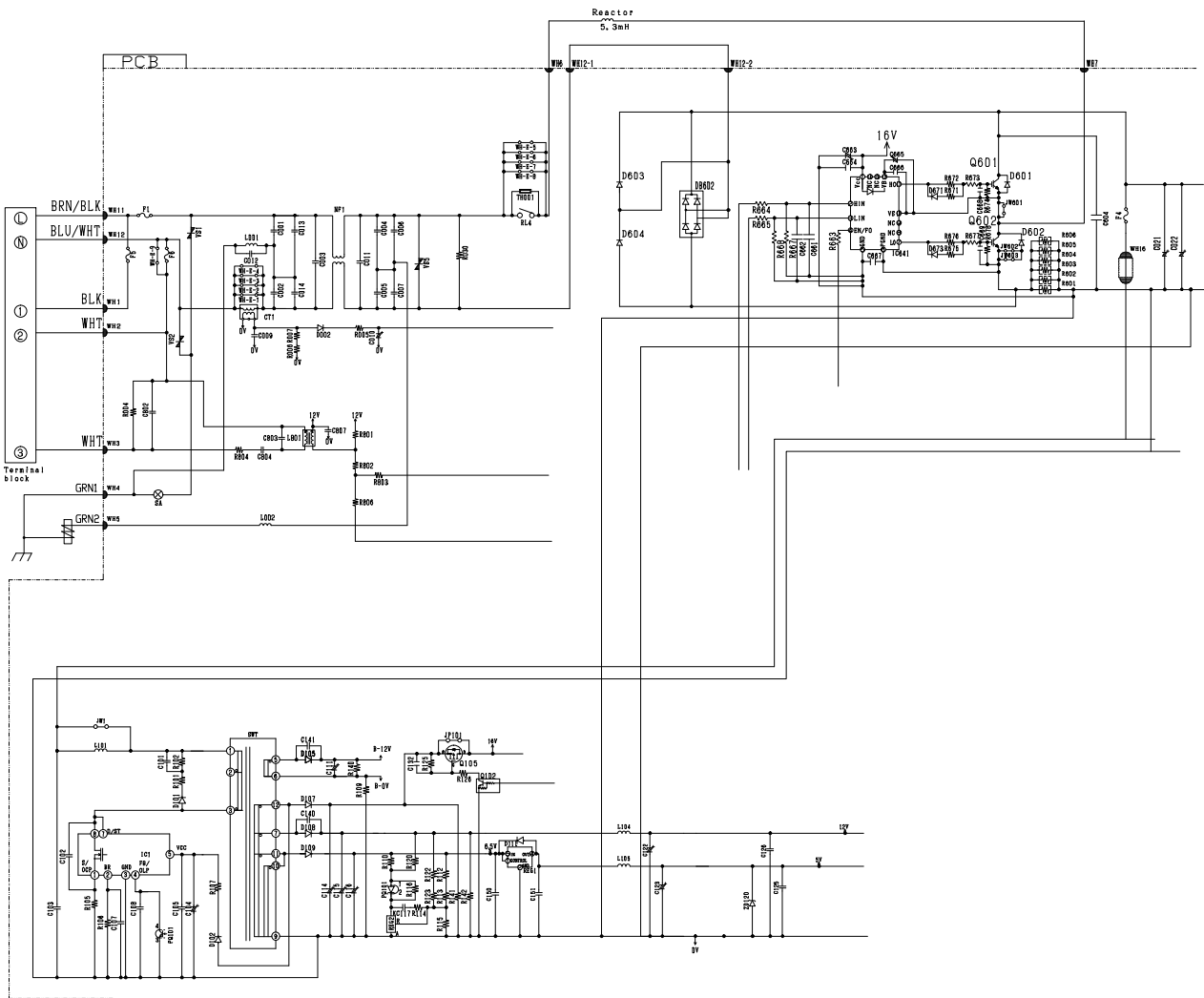

Fig. 2-1

- The 230V AC voltage is rectified to DC voltage (B-12V, 16V, 12V, 5V) pass through switching control IC (ICI), switching transformer.
 - (1) B-12V Power supply for electrical expansion valve.
 - (2) 16V Power supply for Comp. driver circuit of compressor and fan motor, IGBT action.
 - (3) 12V Power supply for 4 way valve relay, power relay, motor current amplification,
 - (4) 5V Power supply for microcomputer, peripheral circuits.

Main parts

(1) C001,C002,C003,C006,C007,C011,C013,C014, NF1

These absorb electrical noise generated during operation of compressor and also absorb external noise entering from power line to protect electronic parts.

(2) Surge Absorber, Varistor1,2.

These absorb external power surge.

(2) REG1

DC/DC convertor IC (DC6.5V→DC5V).

3. P.W.B. for power circuit

Voltage specification of power circuit as shown in below table.

<Checking point>

Output	Spec	Main load	Measuring point	Example of possible failure mode.
5V O/P	$5 \pm 0.4V$	Micon, Thermistor	Tester \oplus : J96 (JUMPER) Tester \ominus : J138 (JUMPER)	Outdoor not operate, no blinking indication
12V O/P	$12 \pm 0.5V$	Micon, IC2, 3 Relay circuit	Tester \oplus : J139 (JUMPER) Tester \ominus : J138 (JUMPER)	Outdoor not operate, no blinking indication
16V O/P	$15.5^{+1.5V}_{-1.0V}$	IPM for Comp IPM for DC fan	Tester \oplus : J111 (JUMPER) Tester \ominus : J138 (JUMPER)	Stop : LD301 3, 4 or 12 times blinking
B-12V O/P	$13^{+2.5V}_{-1.0V}$	Expansion valve	Tester \oplus : J133 (B-12V) Tester \ominus : J130 (B-0V)	Stop : LD301 5 times blinking

※ Power circuit for P.W.B can consider normal if the result is satisfied with above specification.

4.Reversing valve control circuit

This model reversing valve control used to control the relay ON/OFF of the reversing valve, and also control the coil of the reversing valve ON/OFF.

The relay ON/OFF has different type when in the different operation mode.

You can see each operation mode as follows. If the reversing valve not connected or all the condition not the same as follow, it may be something wrong with the reversing valve circuit.

Point operation mode		micon (9) pin - 0V	HIC (35) pin - 0V	CN2 (1)- CN2 (4)
		Cooling	Usual cooling	Hi
Heating	Usual heating	Lo	12V	0V
	Defrost	Hi	0V	AC230V

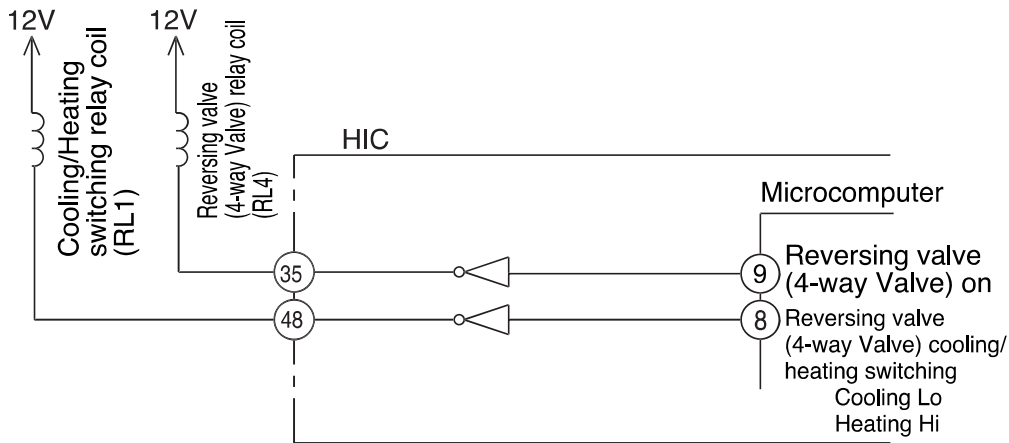
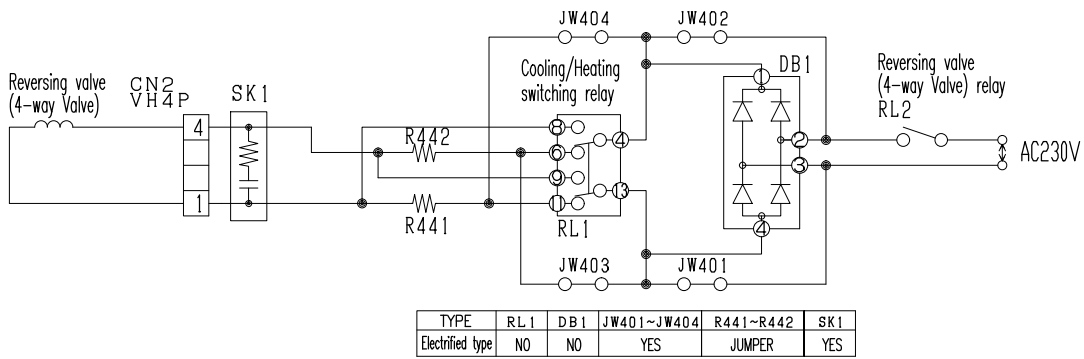

Fig. 4-1

5. Temperature Detection Circuit

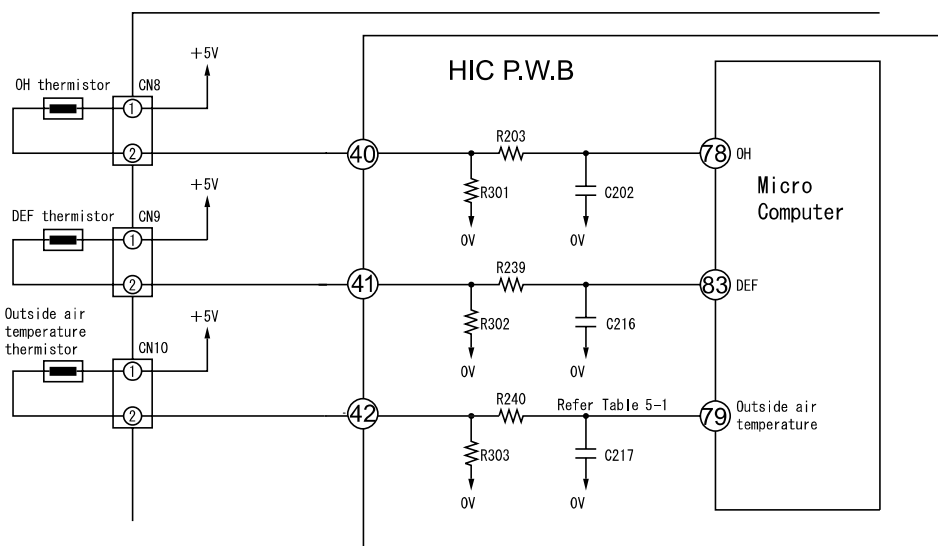

Fig. 5-1

- OH thermistor circuit detect the temperature at the surface of compressor head, DEF thermistor circuit detect the defrosting operation temperature.
 - A thermistor is a negative resistor element which has characteristics that the higher(lower) the temperature, the lower(higher) the resistance.
 - When the compressor is heated, the resistance of the OH thermistor becomes low and $\oplus 5V$ is divided by OH thermistor and R301 and the voltage at pin (78) of microcomputer.
 - Compare the voltage at microcomputer pin (78) and setting value stored inside. If the value exceed the set value, microcomputer will judge that the compressor is overheated and stop the operation.
 - When frost is formed on the outdoor heat exchanger, the temperature at the exchanger drops abruptly. Therefore the resistance of the DEF thermistor becomes high and the voltage at pin (83) of micro computer drops. If this voltage becomes lower than the set value stored inside, microcomputer will enter the defrost control.
 - During defrost operation, the microcomputer will transfer the defrosting condition command to indoor unit via SDO pin of interface of IF transmission output.
 - The microcomputer read the outdoor temperature by Outside Air thermistor and transfer it to the indoor unit, thus controlling the compressor rotation speed according to the set value in the EEPROM of indoor unit and switching the operation mode (outdoor fan on/off etc.) to DRY mode.
- Below table show the typical values of outdoor temperature in relation to the voltage.

Table 5-1

Outside Air Temperature (°C)	-10	0	10	20	30	40
Voltage at both side of R303 (V)	1.19	1.69	2.23	2.75	3.22	3.62

<Reference>

When the thermistor is open, open condition or disconnect, microcomputer pin (78)(79)(83) are approx. 0V;

When thermistor is shorted, they are approx. 5V and LD301 will blink 7 times.

However, an error is detected when only the OH thermistor is shorted and will enter blinking mode after 12 minutes start the compressor operation.

6. Electric expansion valve circuit

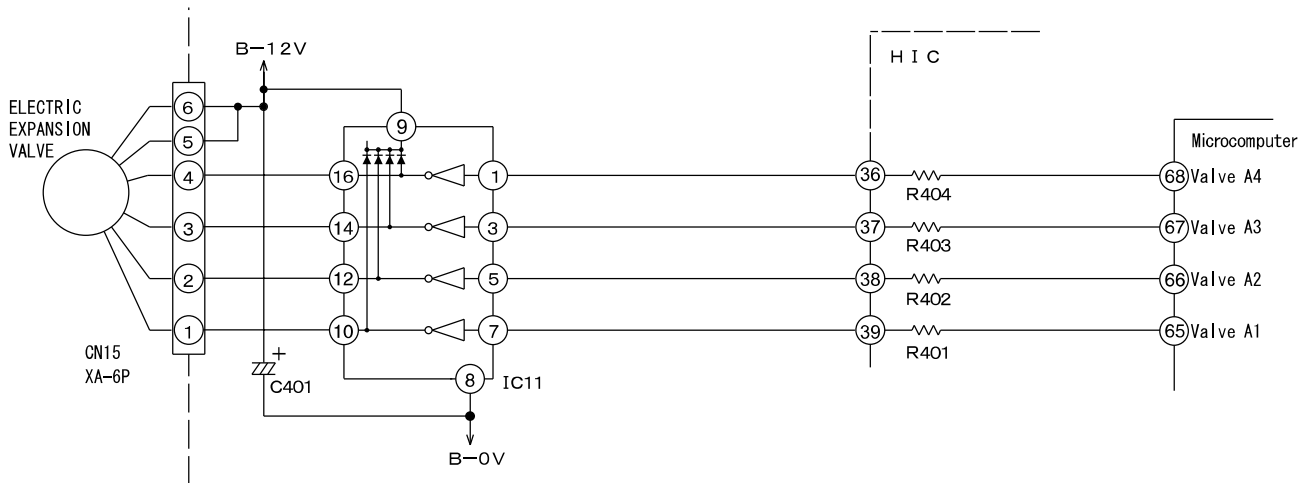

Fig. 6-1

- The electric expansion valve is driven by DC12V. Power is supplied to 1 or 2 phases of 4-phase winding to switch magnetic pole of winding in order to control the opening degree.
- Relationship between power switching direction of phase and open/close direction is shown below. When power is supplied, voltages at pins ④ to ① of CN15 are about 0.9V and 12V when no power is supplied. When power is reset, initial operation is performed for 10 or 20 seconds. During initial operation, measure all voltages at pin ④ to ① of CN15 by using a multimeter. If there is any pin with voltage that has not changed from 0.9V or 12V, expansion valve or microcomputer is broken.
- Fig.5-2 shows logic waveform when expansion valve is operating.

Table 6-1

CN15 pin no.	Wire	Drive status							
		1	2	3	4	5	6	7	8
①	WHT	ON	ON	OFF	OFF	OFF	OFF	OFF	ON
②	YEL	OFF	ON	ON	ON	OFF	OFF	OFF	OFF
③	ORG	OFF	OFF	OFF	ON	ON	ON	OFF	OFF
④	BLU	OFF	OFF	OFF	OFF	OFF	ON	ON	ON

Operation mode
 1→2→3→4→5→6→7→8 VALVE CLOSE
 8→7→6→5→4→3→2→1 VALVE OPEN

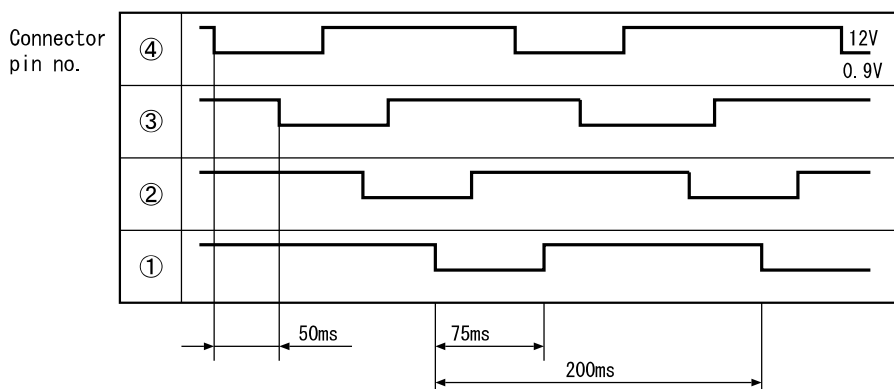

Fig. 6-2

With expansion valve control, opening degree is adjusted to stabilize target temperature by detecting compressor head temperature. The period of control is about once per 20 seconds and output a few pulse.

7. Outdoor DC fan motor control circuit

- This model is built with DC fan motor control circuit inside outdoor electrical unit.

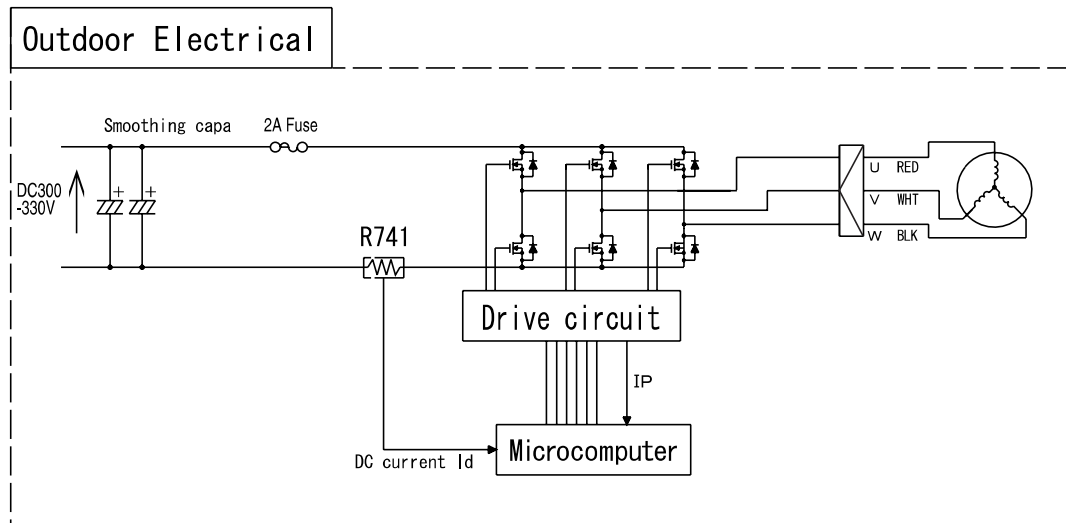

Fig 7-1

This DC fan motor is control by outdoor microcomputer that follow the operating instruction received from indoor microcomputer. The DC current that flow from R741 will presume actual operation speed and control the rotation to follow the operating instruction. Based on this DC current it will detect a over current and other fan motor failure.

(1) Fan motor speed controller during starting

Due to the interference of strong wind etc., operation movement is changed based on fan direction and rotation speed as shown below during starting of operation.

In addition, the fair wind is define as wind that blow to outside direction using Mouth Ring part. At strong and contrary wind ... The rotational speed is not controlled as to protect the equipment and fan will rotate reversely depend on the wind. Automatically start when wind condition become weak.

At contrary wind ... The rotational speed is controlled in fair wind direction after it slowly reduce the speed and finally stop.

At fair wind ... The rotational speed is controlled as it is.

At strong fair wind ... The rotational speed is not controlled as to protect the equipment and fan will rotate reversely depend on the wind. Automatically start when wind condition become weak.

(2) Fan motor speed controller during unit operating

There is a case where fan rpm is reducing during rotating caused by interference of strong wind. If this condition continue in long period, fan will stop rotating. (LD301 : 11 times blinking)
The unit will restart according to control as per during start (1).

(3) Method of confirming self diagnosis LD301 lamp : 12 times blinking

If the unit stop and LD301 on the pwb blinking 12 times [fan lock stop is detected], follow below steps to confirm it.

1. Fan lock stop is detected when something has disturb the fan rotation by inserting material into propeller fan or ice has growing inside outdoor unit caused by snow.
Remove it if found something is bloking the fan.
2. Confirmed that CN24 connector is securely inserted. Fan lock stop is detected also when connector is not properly inserted. Please securely insert if found any disconnection.
3. Fan lock stop also can be detected where strong wind blown surrounding the unit.
Please confirm after restart the unit. (It may take few minutes to operate the compressor)
It is not a malfunction of electrical unit or fan motor if the unit run continuesly after restart the unit.
4. Check fan motor condition as below procedure.

[Checking Fan Motor] procedure

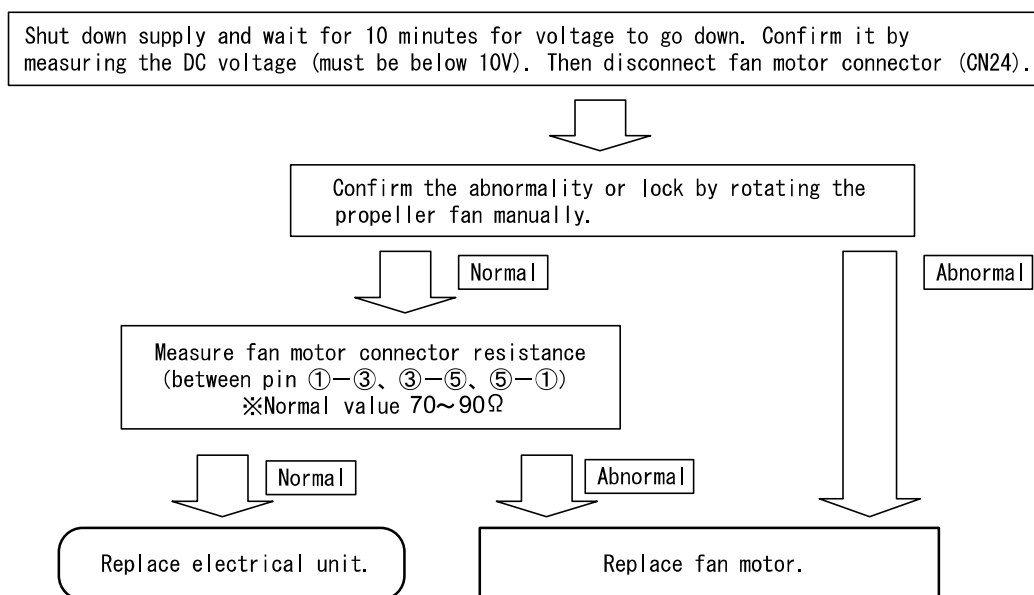

5. Reconnect again fan motor connector (CN24).

※Please confirm above checking procedure if found 2Afuse blown.

If fan motor is broken, replace both electrical unit and fan motor.

Caution

※Beware of electric shock due to high voltage when conducting an operation check.

Power supply for DC fan motor and compressor is common (DC300-330V).

8. Base Heater Circuit

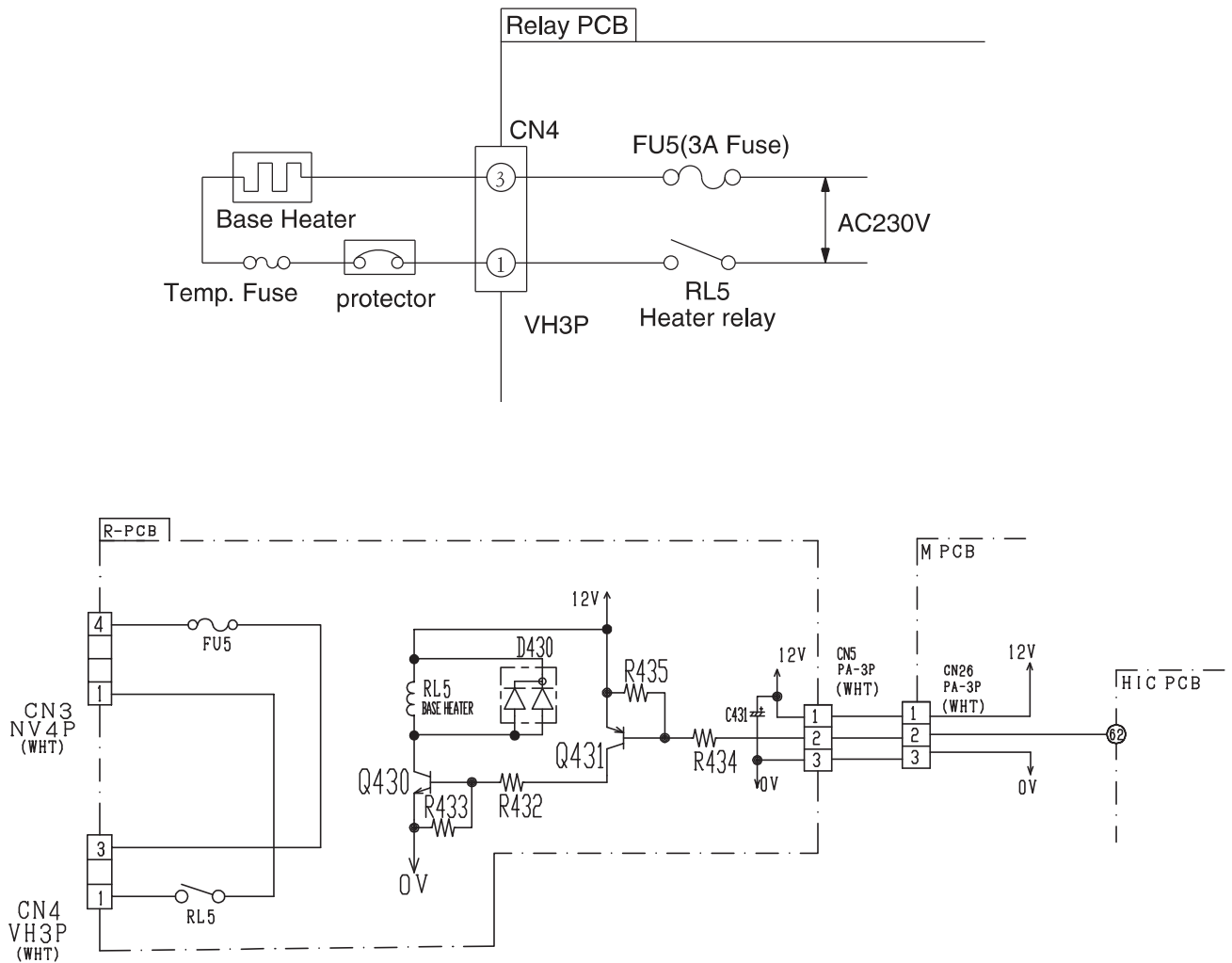
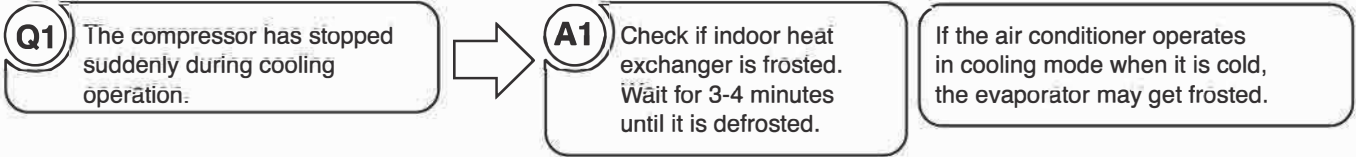

Fig 8-1

- When the outdoor temperature is lower than a certain temperature, the base heater begins to work and the defrosting ability is enhanced.
- When the outdoor temperature is higher than a certain temperature ($7\pm 3^{\circ}\text{C}$), the protector will work and the power supply of base heater will be cut off.
- When the base heater exceeds 119°C , the temp. fuse will act and cut off the power supply.

SERVICE CALL Q & A

COOLING MODE



DEHUMIDIFYING MODE

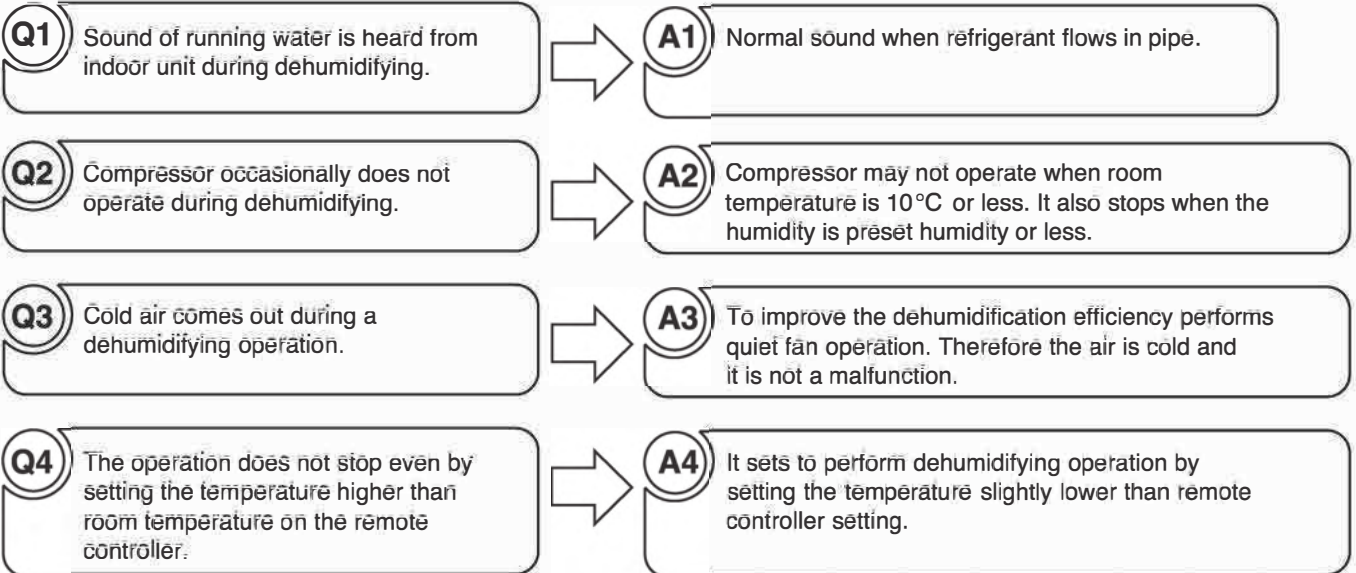

HEATING MODE

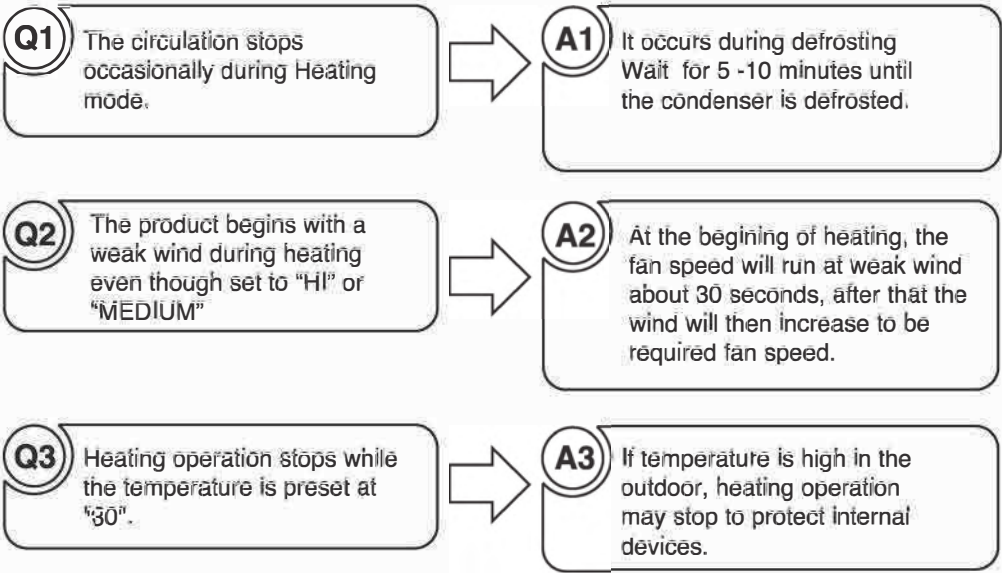

AUTO FRESH DEFROSTING

Q1 After the ON/OFF button is pressed to stop heating, the outdoor unit is still working with the OPERATION lamp blinking.



A1 Auto Fresh Defrosting is carried out : the system checks the outdoor heat exchanger and defrosts it as necessary before stopping operation.

AUTO OPERATION

Q1 How is the automatic operation mode determined?



A1 According to the room temperature heating or cooling operation is automatically selected. Refer to the basic operation section.

Q2 Can I set the room temperature at automatic operation.



A2 The room temperature setting can be set between 16°C - 32°C.

AT STARTING OPERATION

Q1 When only the power switch is turned on, the deflector at the air outlet moves even if the START/STOP button is not pressed.



A1 To ensure correct opening and closing of the deflector, the deflector will move when power is turned on or the unit is to be operated in order to check its fully opened and closed positions.

Q2 When the heating operation is started, the indoor fan does not start immediately and the deflector at the air outlet occasionally does not fully open.



A2 This is because the preheating device is working. It will not start to drive the fan until the refrigerating cycle warms up and warm air blows. Wait for a while. The deflector does not open either during preheating or for one minute after preheating is finished.

Q3 When the unit built behind the gallery (lattice door) is to be started immediately after it has stopped, the unit occasionally will not start.



A3 Such a phenomenon may occur with built-in installation where heat is likely to be stuffy. Install the unit as near to the lattice door as possible so that air is not short-circuited, or provide a partition between the unit and lattice door.

OUTDOOR UNIT FROST WASH

Q1 What is "Outdoor unit frost wash"?

A1 Dust adhering to the heat exchanger of the outdoor unit can be removed by rotating the blower fan of the outdoor unit in the reverse direction, and the heat exchanger can be frozen and thawed to wash away dirt. This suppresses the decrease in air volume of the outdoor unit and cuts unnecessary electricity bills.

Q2 When does "Outdoor unit frostwash" execute?

A2 After operating for about 10 minutes or more and stopping (excluding fan operation), rotate the fan of the outdoor unit in the reverse direction for about 3 minutes each time to remove dust from the heat exchanger. In addition, the heat exchanger of the outdoor unit is frozen and thawed about once every two months to wash away dirt.

Q3 Is it possible to stop "Outdoor unit frost wash" in the middle?

A3 You can stop it with the stop button. The outdoor fan reverse rotation will be performed again when the operation is stopped next time. The outdoor unit will be frozen and washed after about 2 months.

Q4 Can switch to normal operation during "Outdoor unit frost wash"?

A4 After receiving the remote control signal and stopping operation for about 3 minutes, the operation you selected with the remote control will start.

Q5 Room temperature rises during "Outdoor unit frost wash". Warm air comes out from the indoor unit during "Outdoor unit frost wash".

A5 If the room temperature becomes high, "Outdoor unit frost wash" will be interrupted. You can also interrupt with the stop button. You can specify the cleaning time. We recommend that you set the time when you will be away. If you feel uncomfortable, we recommend canceling by selecting the remote control function.

OTHERS

Q1 The indoor fan varies among high air flow, low air flow and breeze in the auto fan speed mode. (Heating operation)



A1 This is because the cool wind prevention function is operating, and does not indicate a fault.

The heat exchanger temperature is sensed in the auto fan speed mode. When the temperature is low, the fan speed varies among high air flow, low air flow and breeze.

Q2 Loud noise from the outdoor unit is heard when operation is started.



A2 When operation is started, the compressor rotation speed goes to maximum to increase the heating or cooling capability, so noise becomes slightly louder. This does not indicate a fault.

Q3 Noise from the outdoor unit occasionally changes.



A3 The compressor rotation speed changes according to the difference between the thermostat set temperature and room temperature. This does not indicate a fault.

Q4 There is a difference between the set temperature and room temperature.



A4 There may be a difference between the set temperature and room temperature because of construction of room, air current, etc. Set the temperature at a comfortable level for the space.

Q5 Air does not flow immediately after operation is started.



A5 Preliminary operation is performed for one minute when the power switch is turned on and heating or dehumidifying is set. The operation lamp blinks during this time for heating. This does not indicate a fault.

Q6 Mold in the room cannot be inhibited even after performing the air conditioner drying operation.



A6 Air conditioner drying operation is to dry the interior of the indoor unit to inhibit the growth of mold. It is not to inhibit the mold growth in the room.

Q7 The interior of the indoor unit seems to be still damp even after performing the air conditioner drying operation.



A7 Condition of the interior of the indoor unit varies depending on usage of the unit and condition of the indoor unit. If it is not dried after the first try, perform the drying more than one time for better effect.

Procedure for Disassemble and Reassemble

INDOOR UNIT

MODEL RAS-PH18PHLAE, RAS-PH24PHLAE

1. Front Panel

- (1) Pull the panel by holding it both lower sides with both hands.

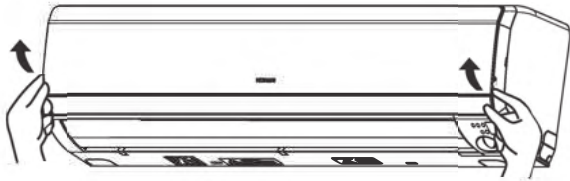

Fig. 1

- (2) When the panel opens full, pull the inner part of the right arm inward and pull the panel forward while closing it gradually.

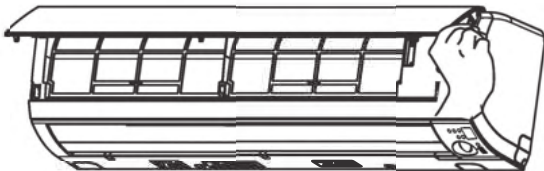

Fig. 2

2. Front Cover

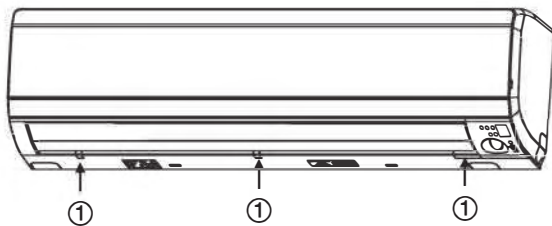

Fig. 3

- (1) Remove the caps and uncrew at lower portion of the front cover.

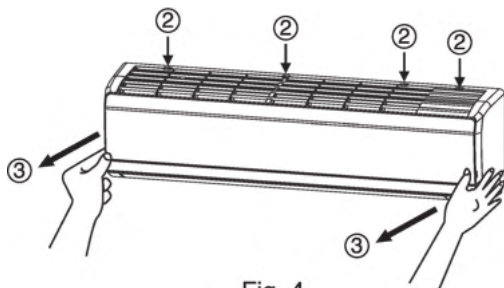

Fig. 4

- (2) Firmly press 4 hooks at top of front cover by tools until the hook release from slot.
- (3) Pull the front cover to front side.

3. Main P.W.B and Reception/Indication P.W.B

- (1) Remove each connector from the lead wire.
- (2) Remove the two P.W.B supports from the main P.W.B.
- (3) After removing the reception/indication P.W.B cover, pull the support hook at the right side of the reception/indication P.W.B and pull out the P.W.B forward.

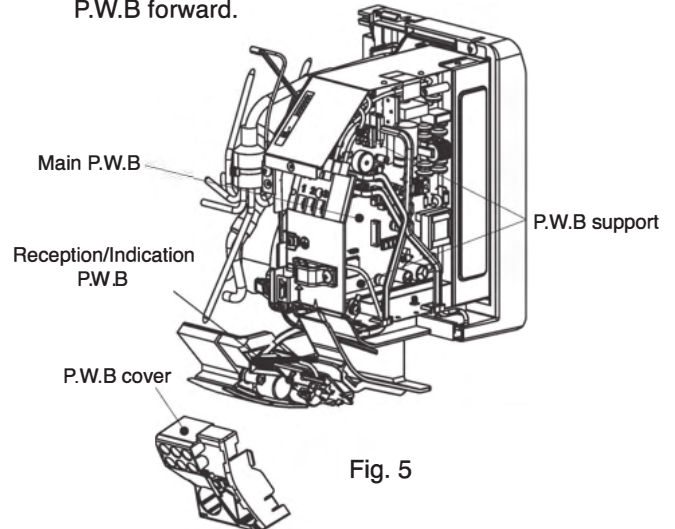

Fig. 5

4. Tangential air flow fan

- (1) Press to unhook (2 places) between drain pan and cabinet and pull the claw forward to remove the drain pan.

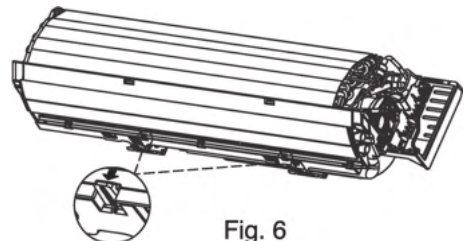

Fig. 6

- (2) Unscrew 2 portions at evaporator support and tangential fan.

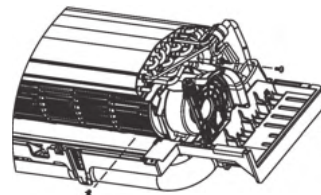

Fig. 7

- (3) Remove the locking hook of the bearing cover from the cabinet. Gently pull up the evaporator with bearing cover by holding it at lower side and pull out tangential fan.

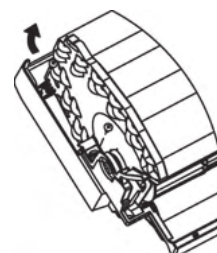
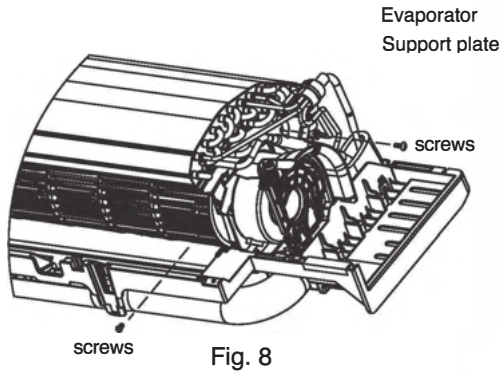

Fig. 8

- (4) Remove the two lock screws from the fan motor holder and one screw from the evaporator support plate.
- (5) Pull up the evaporator by holding it at the lower side. Insert a screwdriver through the space between the evaporator and fan motor holder and loosen the fan lock screws to remove the air flow fan and fan motor.



(5) Fan motor

- (1) Unscrew (3 portions) between fan motor support and cabinet.

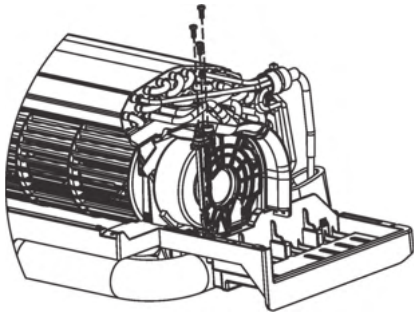

- (2) Release upper fan motor support by pressing hook to unlock and pull to the right.
- (3) Release lower fan support and remove the fan motor.

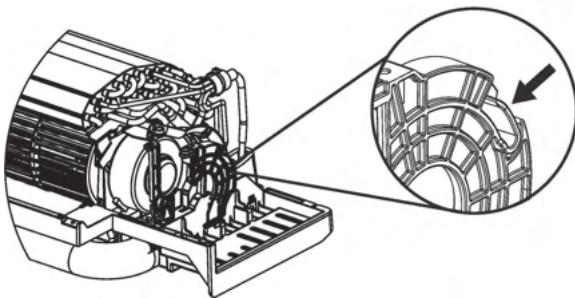
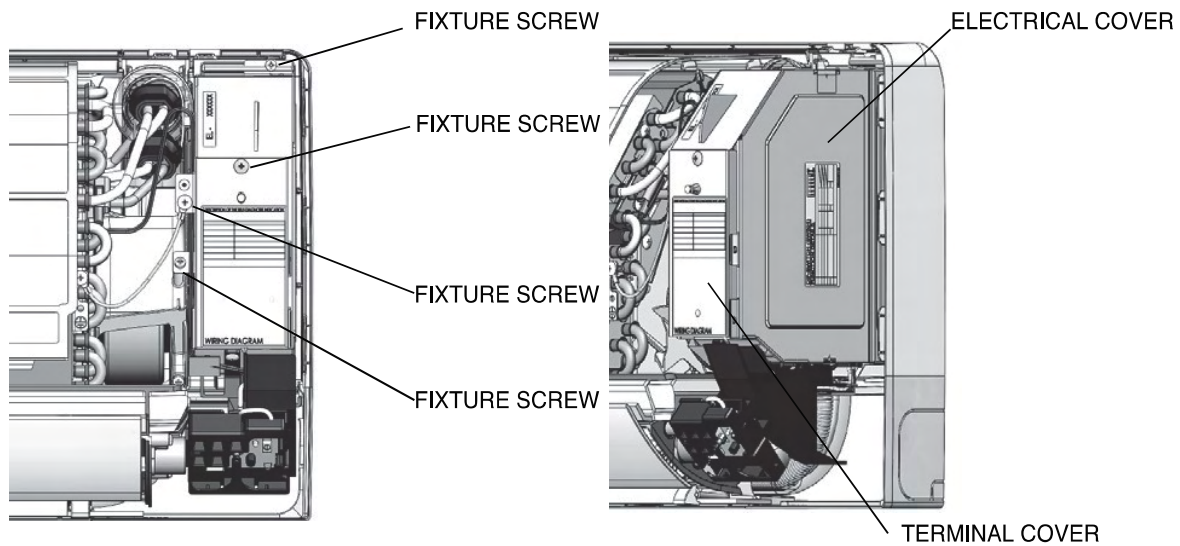

Fig. 8

STRUCTURE OF AN INDOOR UNIT ELECTRIC PARTS



Removing electrical parts

1. Remove the electrical parts cover.
2. Remove the connectors from the CN4 (heat exchange thermistor), CN9 (Vertical sweep motor) and CN2 (fan motor), CN12 (horizontal sweep motor).
3. Remove four lock screws.

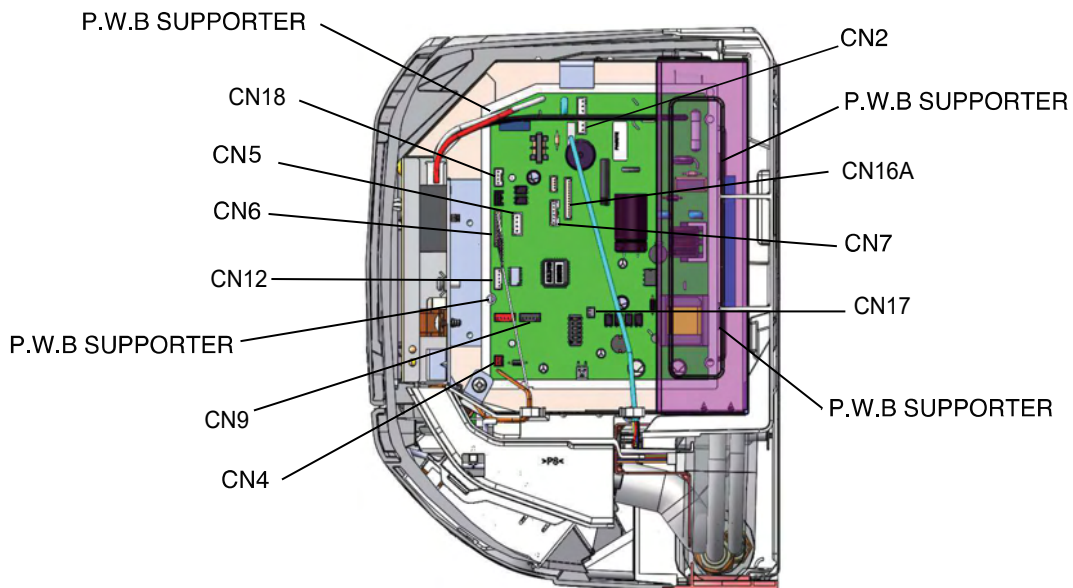

Removing control P.W.B.

1. Pull off all the wires from terminal 1,2,3 or remove the terminal [1,2,3] from the chassis.
2. Remove the P.W.B from the P.W.B support.

Remove the indicating P.W.B.

1. Remove the connector from the CN16A on the control P.W.B.
2. Remove the upper hook from the indicating P.W.B. lock resin, pull the P.W.B. forward a little and remove it.

Procedure for Disassembly and Reassembly

OUTDOOR UNIT

MODEL RAC-PH18WHLAE, RAC-PH24WHLAE

1. Electrical parts

- (1) Remove the service value cover lock screws and lower the cover to remove it.
- (2) Remove the top cover lock screw and raise the cover to remove it.

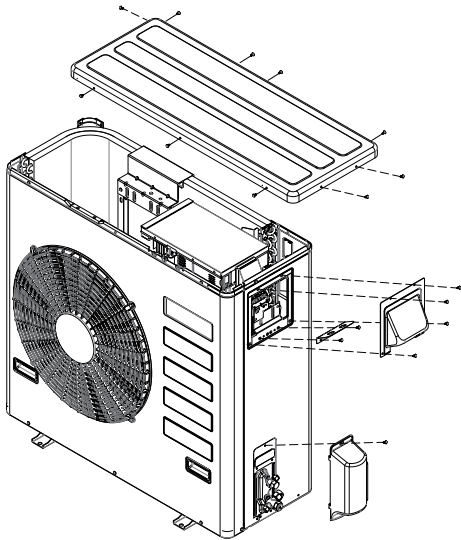

Fig. 1

- (3) Remove the terminal plate cover.

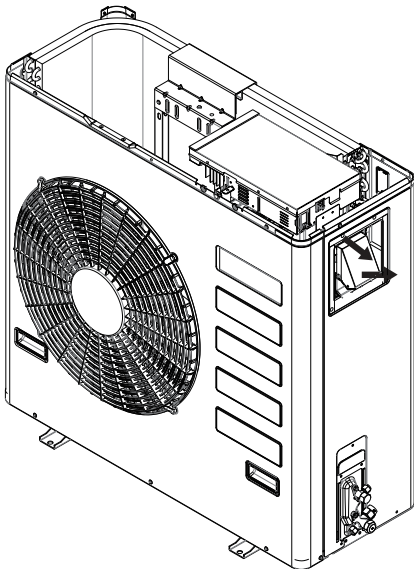

Fig. 2

- (4) Lower the right side of the front cover and pull it forward. Then, remove the cover from the hook.

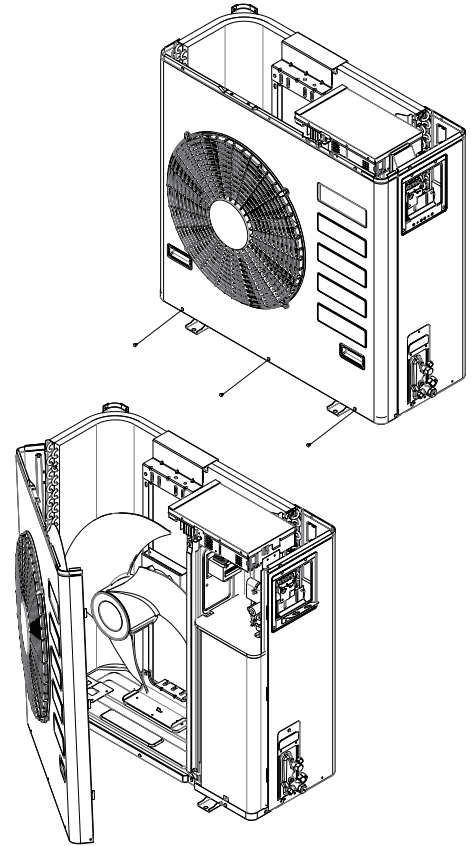

Fig. 3

- (5) Remove the terminal block screw, inductance line, line clip, earth line.

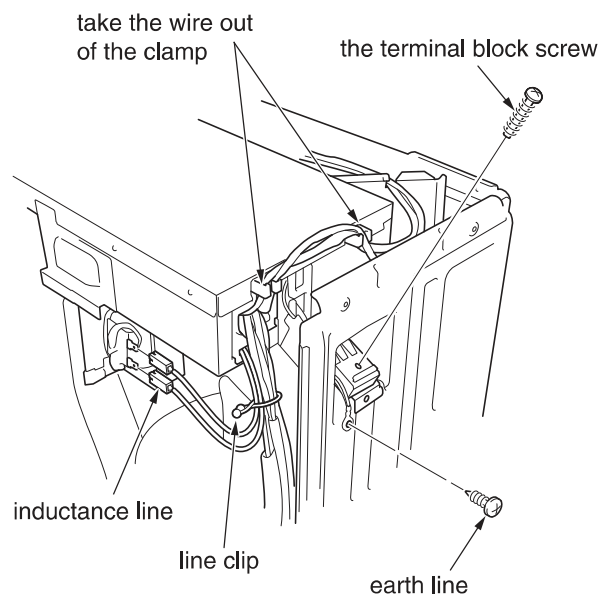

Fig. 4

(6) Set the electrical box upside down.

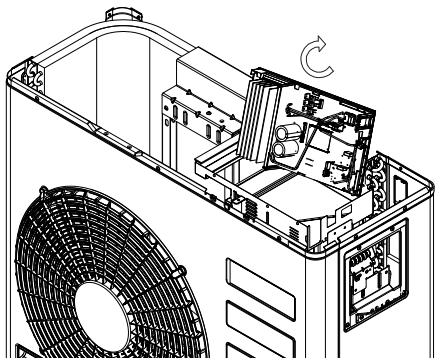

Fig. 5

(7) Remove each connector and earth cable from the lead wire. Then, remove the electrical box.

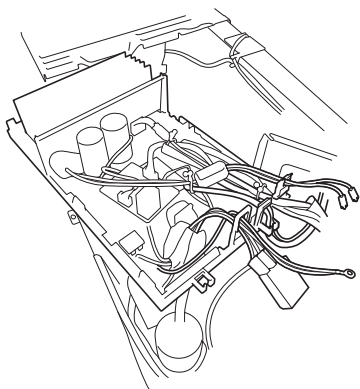

Fig. 6

2.The P.W.B.

(1) Remove the the electrical box cover.

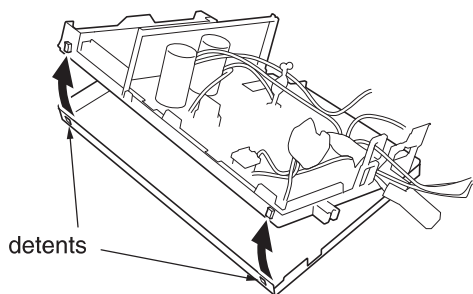

Fig. 7

(2) Remove the P.W.B. from the support.

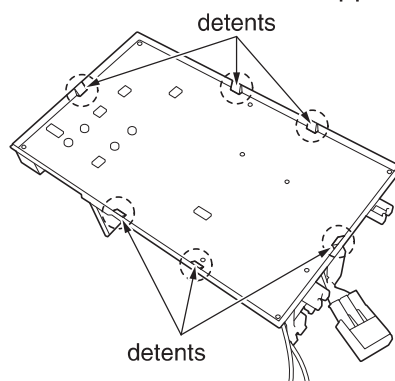

Fig. 8

Other instructions

(1) Detaching and reattaching the receptacles for tab terminal

All the receptacles for connecting tab terminals are with a locking mechanism. Forcibly pulling any such receptacle without unlocking it will destroy it. Be on guard.

When reconnecting it, insert it securely all the way home.

· Receptacle types and how to unlock them

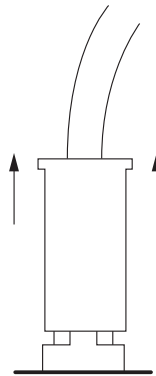

Vertical (with a resin case)

Hold the resin case and pull it out.

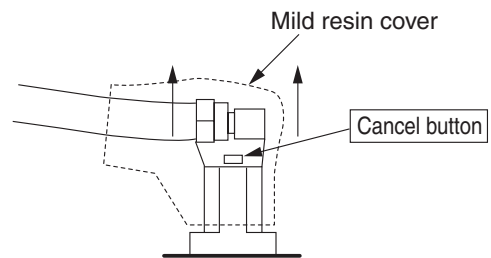

Horizontal (with a mild resin cover)

Hold the cancel button down on the mild resin cover while pulling it out.

(2) Detaching and reattaching the board connector

The product comes equipped with many board connectors provided with lock mechanism. Forcibly pulling any such part without unlocking it will destroy it. Be on guard. When reconnecting it, insert it securely all the way home.

Pinch the locking mechanism with your fingers and pull it out unlocked.

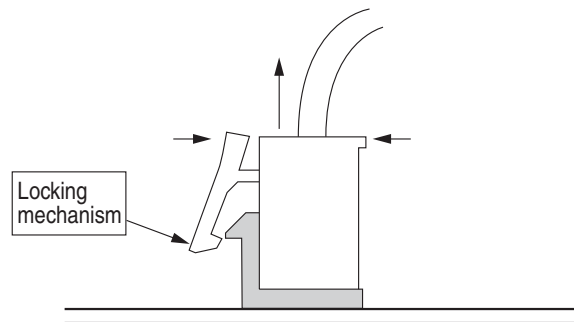

(3) Do not detach or reattach the connectors while energized

Do not under any circumstances detach or reattach the connectors while energized. That would destroy the board components and fan motor. For both the indoor and outdoor boards, ensure that the smoothing capacitor has discharged its electricity fully before you do your work.

No	Function	Description
1	Self-diagnosis display [Display on the indoor unit side]	<ul style="list-style-type: none"> · The failure mode detected on the indoor unit side is displayed by blinking the "timer lamp". And a failure detected on the outdoor unit side will be indicated by the "time lamp" blinking 4 times. · If the outdoor unit side detects a failure, the product will first conduct several operation retrials. There are some failure modes with no lamp display while retrials are continued. <p>[Failure mode where retrials are continued and the indoor unit lamp does not end up giving a display]</p> <ul style="list-style-type: none"> OH thermistor heat-up Overload lower limit cut Low-frequency things
	[Display on the outdoor unit side]	<ul style="list-style-type: none"> · The failure mode detected on the outdoor unit side is displayed by blinking the "LD301". Detecting a failure will stop the outdoor unit and keep blinking the LD301 until it is restarted. (The communication error will persist until the communication is reestablished.)
2	Self-diagnosis memory	<ul style="list-style-type: none"> · The failure modes detected on the indoor and outdoor unit sides are stored in the nonvolatile memory of the indoor unit and can be read later on. (The memory will remain even after power-off.) · The failure modes detected on the outdoor unit side are written in memory every time any such mode occurs. The failure mode can therefore be detected on the indoor unit side without waiting for the retry frequency to reach the display of the indoor unit lamp. Moreover, the normal self-diagnosis display function which rarely occurs will store and display failure modes that do not end up displaying the indoor unit lamp. (Any such mode may be unable to be stored if indoor or outdoor communications is in a failure.) · The product stores 5 last-stored failure modes. · There is a function for deleting memory. Once you clear the memory and run the product for several days, you can read the failure modes and check them, thereby detecting the less frequent failure phenomena. · Failure modes can be checked by both the blinking of the lamp of the indoor unit and the display of the remote control liquid crystal display.

※The "self-diagnosis function of the communication circuit" available in our conventional models is now incorporated as part of the normal self-diagnosis function. In the case of a failure in the communication circuit, you do not have to conduct a special operation and the operations can be automatically divided into 3 blinking operations and 12 blinking operations of the timer lamp. However, a strong external noise may have resulted in 12 times of blinking.

DISCHARGE, PROCEDURE AND POWER SHUT OFF METHOD FOR POWER CIRCUIT



Caution

- Voltage of about 350 V is charged between the terminal of smoothing capacitors.
- During continuity check for each circuit part of the outdoor unit, be sure to discharge the smoothing capacitors.

Discharge Procedure

1. Turn off the power.
2. After power is turned off, wait for 10 minutes or more. Then, remove electrical parts cover and apply soldering iron of 30 to 75 W for 15 seconds or more to IPM (24) and IPM (20) terminals on the main P.W.B. as shown in the figure below, in order to discharge voltage in smoothing capacitor.

Do not use a soldering iron with transformer: Otherwise, thermal fuse inside transformer will be blown.

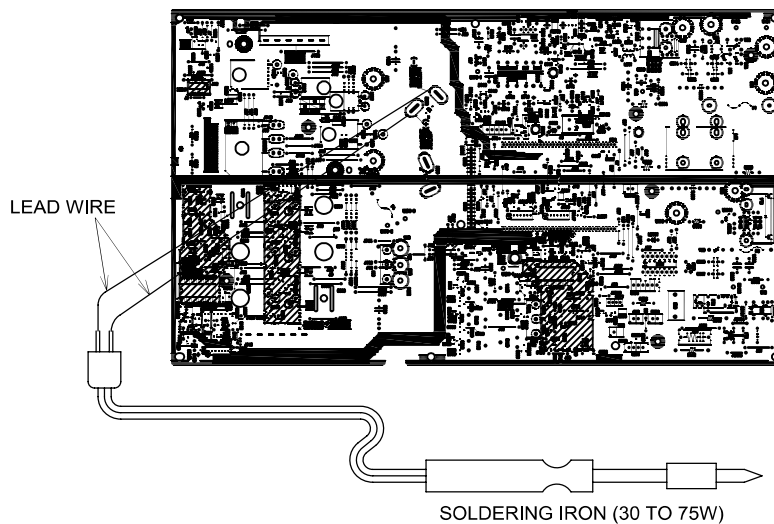

SELF-DIAGNOSIS DISPLAY MODE (INDOOR SIDE)

While the "timer lamp" (orange), of the indoor unit is blinking, troubleshoot the product while referring to the table below.

- How to count the lamp blinking frequency
 - The product will repeat blinking with 2-second intermissions.
 - The blinking speed is as follows: on for 0.35 seconds and off for 0.35 seconds.

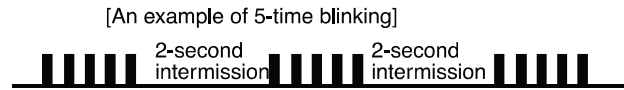

- If you wish to try another operation while the lamp is blinking, operate the START/STOP button on the remote control unit twice. The first push will reset the indoor microcomputer, while the second will activate the product

Refer to the table below if the timer indicator (orange) is blinking.

LAMP BLINKING MODE	MAIN DEFECTIVE
ONCE	REFRIGERANT CYCLE DEFECTIVE
2 TIMES	FORCED OPERATION OF OUTDOOR UNIT
3 TIMES	INDOOR INTERFACE CIRCUIT
4 TIMES	OUTDOOR ELECTRICAL ASSEMBLY DEFECT
9 TIMES	ROOM OR HEAT EXCHANGER THERMISTOR OR HUMIDITY SENSOR DEFECT
10 TIMES	OVERCURRENT IN DC FAN MOTOR
12 TIMES	OUTDOOR INTERFACE CIRCUIT
13 TIMES	IC531 OR EEPROM DATA DEFECT
(- LIGHT FOR 0.35 SEC AT INTERVAL OF 0.35 SEC)	

- * IF THE INTERFACE CIRCUIT IS DEFECTIVE WHEN THE POWER IS TURNED ON, THE SELF-DIAGNOSIS INDICATION WILL NOT WORK.
- * IF THE INDOOR UNIT CAN NOT BE OPERATED AT ALL.

REFER TO THE BELOW TABLE IF THE INDOOR UNIT DOES NOT WORK AT ALL.

FIX CN2 CONNECTOR	ACTION /REPLACEMENT PARTS, etc
FU1 (3.15A) FUSE BLOWN	REPLACE THE PART WHICH CAUSED BLOWING/DISCONNECTION OF FU1(3.15A) FUSE
COME OFF OR DISCONNECTION OF THE CONNECTOR FOR INDICATING P.W.B	FIX CN16 CONNECTOR
FAILURE OF CONTROL P.W.B	REFER TO THE SERVICE GUIDE FOR HOW TO DETERMINE THE FAILED PART

Lighting mode of the self-diagnosis lamp

2 Lighting mode of the self-diagnosis lamp

⚠️ ⚡ DANGER (DC350V)

CUT THE POWER SOURCE AND WAIT MORE THAN 10 MINUTES BEFORE SERVICING WORK. MEASURE DC VOLTAGE(※1) AND CONFIRMED THAT IT IS MUST BE LESS THAN 10V.

LED(※1) INDICATION DURING COMPRESSOR OPERATE	
LD301	OPERATION STATUS
LIT	NORMAL
BLINK REPEATINGLY WITH 2 SECONDS LIT - 0.3 SECONDS OFF	OVERLOAD (NORMAL)

※1 DC VOLTAGE VALIDATION, LED POSITION AND FAN OPERATION REFER TO THE SERVICE MANUAL.

[WIRING DIAGRAM]

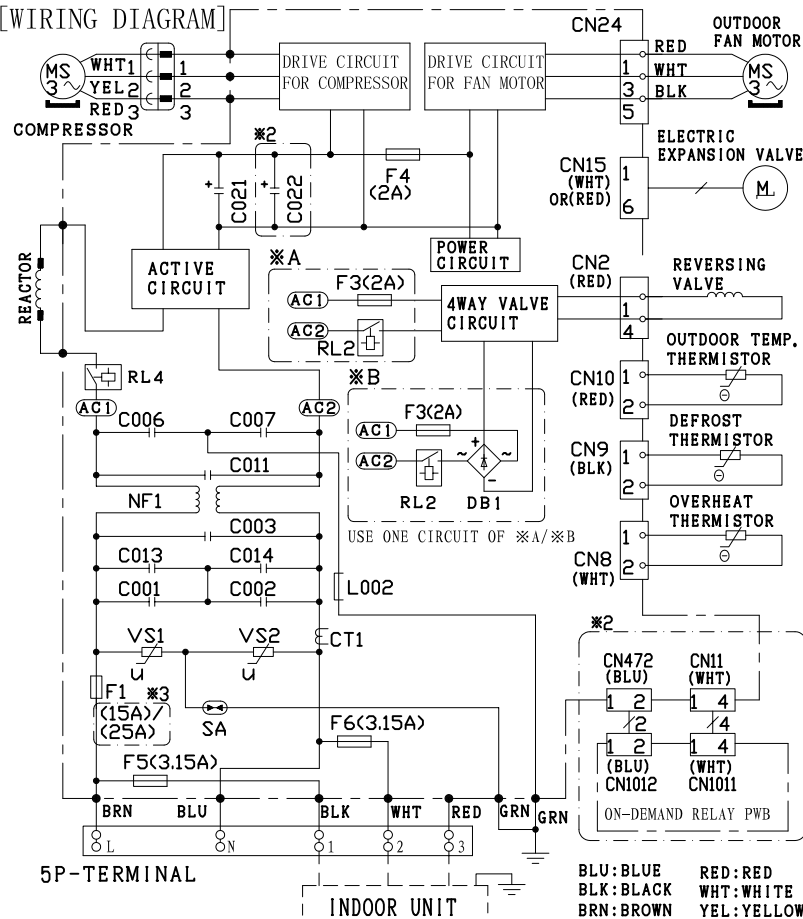

LED INDICATION DURING STOP

LD301	SELF-DIAGNOSE CONTENT	CHECKING POINT&REPAIR METHOD
OFF	NO POWER SUPPLY	NO POWER SUPPLY AT TERMINAL "L - N" → CHECK POWER CABLE CONNECTING CABLE MISCONNECTION → CHECK CONNECTING CABLE REACTOR CONNECTOR HALF INSERTION → CHECK REACTOR CONNECTOR F4 (2A FUSE) BLOWN → CHECK OUTDOOR FAN MOTOR
	NORMAL STOP	NOT MALFUNCTION
1 TIME BLINK	RESET STOP	FAN OPERATION※1, WAITING COMPRESSOR TO START → NORMAL OTHER → IF STILL NOT SOLVE AFTER CHECK THE CONNECTING CABLE, CHANGE ODU CONTROLLER
2 TIMES BLINK	PEAK CURRENT CUT	SERVICE VALVE NOT OPEN → CHECK SERVICE VALVE
3 TIMES BLINK	ABNORMAL LOW SPEED ROTATION	COMPRESSOR CONNECTOR NOT CONNECTED → CHECK CONNECTOR OUTDOOR UNIT SURROUNDING IS BLOCKED → REMOVE THE CAUSE OF BLOCKING.
4 TIMES BLINK	SWITCHING FAILURE	THE CYCLE PIPE ABNORMAL → CHECK THE CYCLE PIPE
5 TIMES BLINK	OVERLOAD LOWER LIMIT CUT	(ODU(※4) CONTROLLER IS ABNORMAL OR COMPRESSOR IS ABNORMAL) (REFER TO THE SERVICE MANUAL [SELF-CHECK])
6 TIMES BLINK	COMPRESSOR TEMPERATURE RISE	SERVICE VALVE NOT OPEN, REFRIGERANT LEAK → CHECK SERVICE VALVE, RE-CHARGE THE REFRIGERANT BAD CONNECTOR INSERTION, CIRCUIT DEFECT → CHECK THE CONNECTOR, CHANGE ODU CONTROLLER
7 TIMES BLINK	THERMISTOR ABNORMAL	THERMISTOR CONNECTOR HALF INSERT → INSERT CONNECTOR SECURELY THERMISTOR WIRE SHORTED OR CUT, CIRCUIT DEFECT → CHANGE THERMISTOR, CHANGE ODU CONTROLLER
9 TIMES BLINK	COMMUNICATION ERROR	F CABLE MISS CONNECTION, DISCONNECTIN → CHECK THE F CABLE COMMUNICATION CIRCUIT ABNORMAL → CHANGE ODU CONTROLLER
10 TIMES BLINK	POWER SUPPLY VOLTAGE ERROR	AC VOLTAGE ABNORMAL (BEYOND RATED VOLTAGE ±10%) → SUPPLY CORRECT VOLTAGE AC VOLTAGE NORMAL (WITHIN RATED VOLTAGE ±10%) → CHANGE ODU CONTROLLER
11 TIMES BLINK	FAN STOP BY STRONG WIND	TEMPORARY STOP DUE TO STRONG WIND → FAN WILL RE-START AFTER WIND BECOME WEAK
12 TIMES BLINK	FAN LOCK STOP	TEMPORARY STOP DUE TO STRONG WIND. → FAN WILL RE-START MOVING LATER SOMETHING BLOCKED SURROUND OUTDOOR UNIT → REMOVE THE OBSTRUCTION CONDUCT OUTDOOR FAN MOTOR CHECK → REPLACE THE DEFECT PART
13 TIMES BLINK	EEPROM READING ERROR	CHANGE ODU CONTROLLER
14 TIMES BLINK	DC VOLTAGE ABNORMAL	CONFIRM AC POWER SUPPLY & DC VOLTAGE IS NORMAL. → CHANGE ODU CONTROLLER COMPRESSOR LOAD ABNORMAL → INSPECT THE COMPRESSOR
15 TIMES BLINK	CIRCUIT ABNORMAL	CHANGE ODU CONTROLLER (SOME MODELS HAVE NOT 15 TIMES BLINK)
16 TIMES BLINK	HIGH LOAD DURING STOP	SERVICE VALVE NOT OPEN → CHECK SERVICE VALVE SOMETHING BLOCKED SURROUND OUTDOOR UNIT → REMOVE THE CAUSE OF BLOCKING DUST ON INDOOR UNIT FILTER → CLEAN UP THE FILTER

[OUTDOOR FAN MOTOR CHECK] DIAGNOSIS METHOD

- SWITCH OFF MAIN POWER SUPPLY.
- UN-INSERT OUTDOOR FAN MOTOR CONNECTOR CN24.
- MAKE SURE NO ABNORMALITIES AT THE FAN SHAFT.
- MEASURE RESISTANCE AT FAN MOTOR CONNECTOR CONTACT.
NORMAL RESISTANCE BETWEEN EACH TERMINAL
REFER TO THE SERVICE MANUAL.
- IF NO ABNORMAL AND FAN MOTOR NORMAL,
CHANGE ODU CONTROLLER.

OTHERS CHECKING POINT

- [REVERSING VALVE NOT OPERATE ERROR]
→ UN-INSERT THE CONNECTOR AND CHECK
CHECK THE LEAD WIRE.
→ IF OK CHECK F3(2A) FUSE, IF BROKEN
REPLACE THE FUSE OR ODU CONTROLLER.
- [COMMUNICATION ERROR] OR
OUTDOOR UNIT NO OPERATION
→ CHECK CONNECTING CABLE BETWEEN
INDOOR UNIT AND OUTDOOR UNIT.

※2 SOME MODELS NOT NEED TO INSTALL THE CIRCUITS IN DASH DOT.

※3 F1 CURRENT VALUE BE DIFFERENT FOR DIFFERENT MODELS.

※4 ODU = OUTDOOR UNIT.

0022422A

PRECAUTION FOR CHECKING



DANGER

1. Remember that the 0V line is biased to 162V in reference to the ground level.
2. Also noted that it takes about 15 minutes until the voltage fall after the power switch is turned OFF.

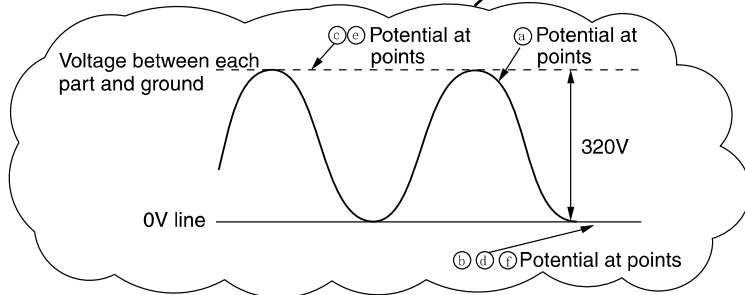
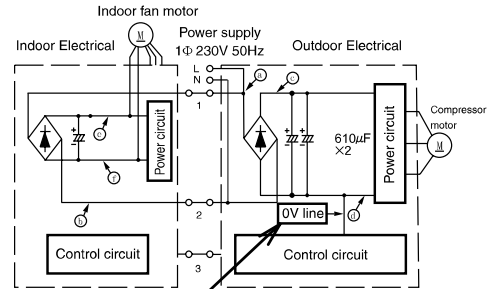
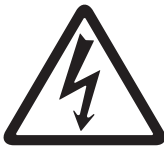

DANGER



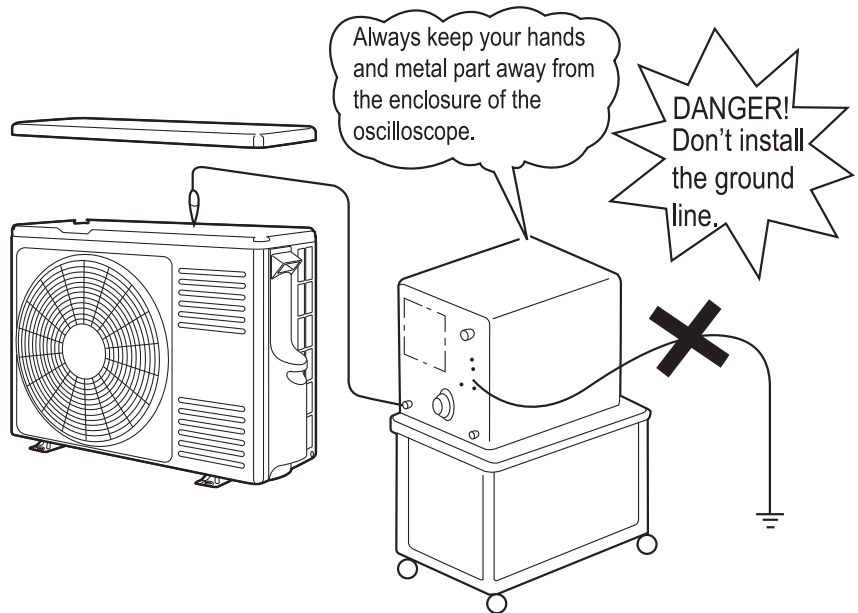
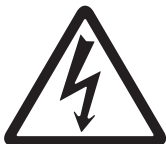

When using an oscilloscope, never ground it. Don't forget that high voltages as noted above may apply to the oscilloscope.







Self Diagnosis Memory Function



Failure mode are stored in the non-volatile memory of indoor unit and can be redisplay by operating the remote controller. This function is very useful in checking the failure modes when either unintentionally switching OFF power supply or restarting the unit operation without conforming the number of blinking of self diagnosis lamp. Remote controller can be redisplay up to last 5 failure modes from the memory. However, failure modes which are rarely occur are also stored in the memory which caused the number of failure easily become more than 5. Thus, for some failure modes which are unable to retrieve because of the remote controller limit to redisplay only 5 failure modes, it can be found by clearing up the memory first then recheck the memory content again during the visit at the customer place.

<How to redisplay failure diagnosis>





1. Turn OFF the circuit breaker on the unit side. (wait for around 5 second)
2. Press the [ (MODE)] button and select [Cool mode ()]. The remote should be in 'Standby' mode.
3. Turn the circuit breaker ON.
4. Set the room temperature on the remote controller to 32°C by pressing the [ (Temp Up)] button.
5. Set which failure information that need to be redisplay by using [ (Fan Speed)] button.

(Refer to the corresponding table below)

Fan Speed		Failure data stored
Auto		Latest
Hi		2nd latest
Med		3rd latest
Lo		4th latest
Silent		Oldest

6. While directing the remote controller towards the receiver of the indoor unit, press [ (Temp Up)] button and [ (On/Off)] button simultaneously.
(The remote controller perform signal transmission with the indoor unit)
7. The indoor unit beep [Pi-] to indicate that it has just received the signal to redisplay the failure mode.
8. Start counting the number of blinking of the Timer lamp (indicating indoor error) and Operation lamp (indicating outdoor error) and confirm it with indoor unit or outdoor unit self-diagnosis table.
9. After everything is completed, turn OFF the circuit breaker (must do without fail).









<How to clear the stored data>

1. Conduct the redisplay of failure mode. (Follow above procedure)
2. Turn the circuit breaker OFF. (Wait for 5sec or more)
3. Press the [ (MODE)] button and select [Dry mode ()]. The remote should be in 'Standby' mode.
4. Turn the circuit breaker ON.
5. Set the room temperature on the remote controller to 16°C by pressing the [ (Temp Down)] button.
6. While directing the remote controller towards the receiver of the indoor unit, press [ (Temp Down)] button and [ (On/Off)] button simultaneously.
(The remote controller perform signal transmission with the indoor unit.)
7. The indoor unit beep for a few second [Pi-] to indicate that it has just receive the signal. The data has been cleared.
8. After everything is completed, turn OFF the circuit breaker (must do without fail).





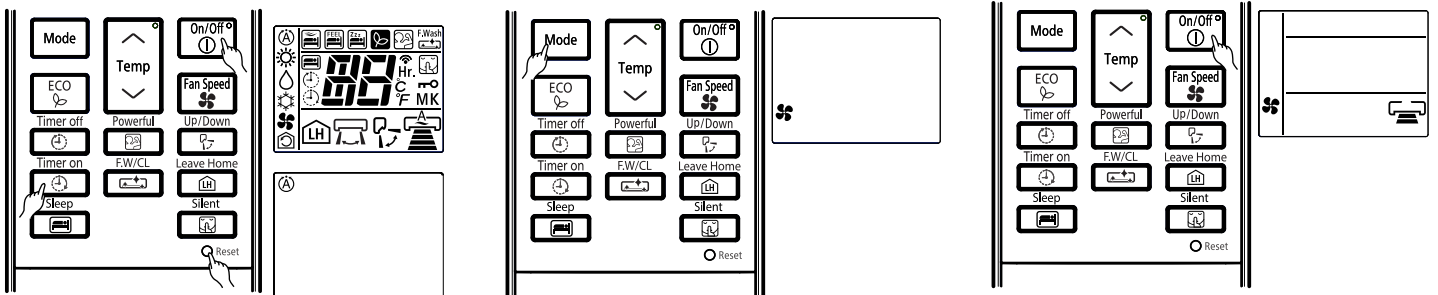

Notes:

- * This function is valid only once right after the power supply is turned ON and it will not work if other remote controller operation was made prior to it.
Also, this function will not work if above steps were not followed accordingly. (If the above procedures are not working, please repeat from the start.)
- * If nothing was stored in the memory, the lamp does not blink even the redisplay operation is carried out.
- * To carry out normal operation, turn OFF the power supply. After redisplay operation, the remote controller reception will not work as normal.

HOW TO CHANGE THE SHIFT VALUE SETTING TEMPERATURE



1. While pressing and holding  (ON/OFF) button and  button, press **RESET**  [RESET] button on the same. Release **RESET**  [RESET] button only and make sure that all marks on the remote controller display are indicated then release the  (ON/OFF) button and  button. Remote controller now enters "Shift Value Change Mode".
2. Press the  (MODE) selector button so that the display indicates  (FAN) mode.
3. Press the  (ON/OFF) button and FAN operation will be started.

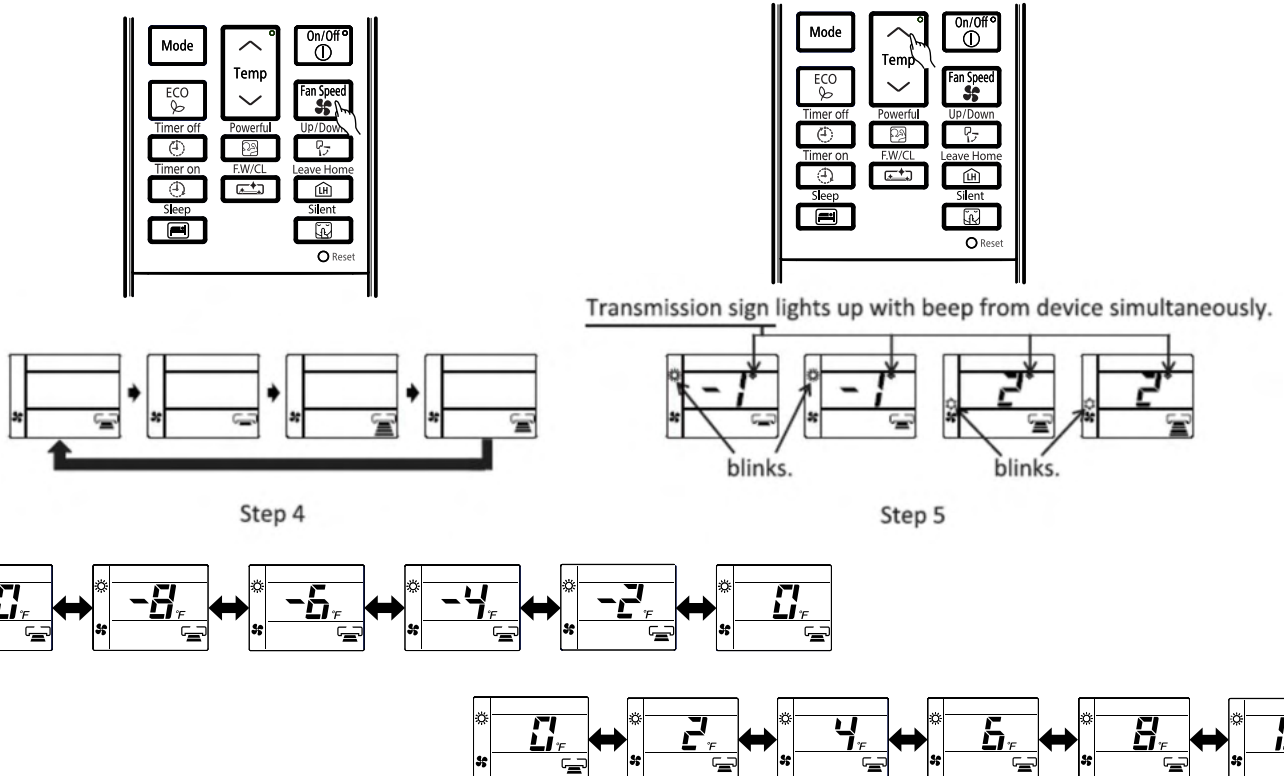

4. Set the FAN SPEED with the  (FAN SPEED) button according to the following FAN speed setting in order to choose the desired operation mode that is required for shift value setting temperature modification.
 - To change the shift value for COOLING mode operation, select either  (HIGH) or  (MED) FAN SPEED.
 - To change the shift value for HEATING mode operation, select either  (LOW) or  (SILENT) FANSPEED.
5. Press the (TEMP  or ) button to change the shift value. (The shift value changed with device producing beep sound.)



NOTE :

1. The displayed shift value,  (HEAT) and  (COOL) symbol on the remote controller display will disappear after 10 seconds.
2. The changed shift value will remain unchanged after turned off the power.
3. If "0" is displayed on the remote controller display, it indicates the shift value is now at the initial setting.

SETTING THE PREVENTION OF MUTUAL INTERFERENCE FOR REMOTE CONTROLLER

a.) Other indoor circuit breakers should be disconnected.



b.) Remove the back cover of the remote control.

c.) Cut the jumper as shown below.

d.) Press **Reset** button after installing the battery.

e.) Corresponding to the room electrical box dial code 6 to dial on.

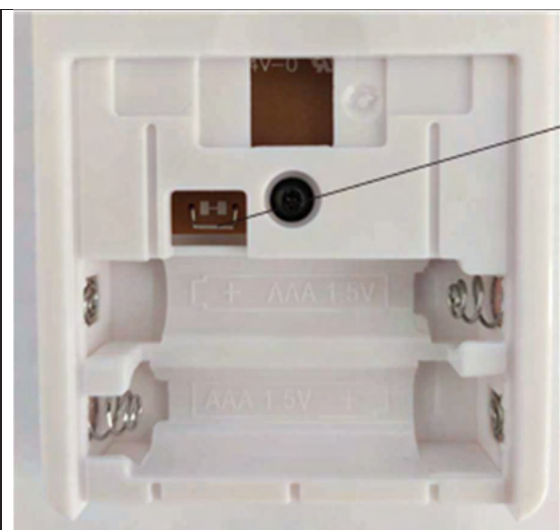

Cut (Attention: Remove the battery before cutting. Do not cut with electricity).



f.) Please use the remote control to check the available models of corresponding indoor machines.

HOW TO CHANGE THE FAN SPEED IN COOLING MODE DURING THERMO OFF

The fan speed in Cooling Mode during thermo off can be changed by the remote controller.
 (This procedure shall be implemented strictly by service personnel only.)
 It is possible to return it to the default setting.

PROCEDURE

Press  [POWERFUL] button and  [ECO] button simultaneously for about 5 seconds when the remote controller is OFF.

Transmission sign lights up with beep from indoor unit simultaneously.

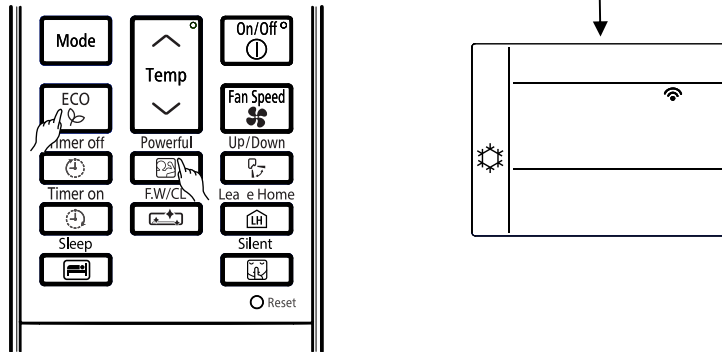

Beep sound pattern :
 1) Default setting : Short beep
 2) Changed setting : Double beep

	Fan speed during thermo off
Default Setting	Ultra low
Changed Setting	Set fan speed (When auto fan speed is set, the fan speed is low)

NOTE :

- (1) The selected fan speed will remain unchanged after the unit is turned off.
- (2) If Timer reservation has been set, it will be canceled.
- (3) During time setting and timer setting, this operation cannot be set.



HOW TO CHANGE THE INTERMITTENT FAN HEATING SETTING

The intermittent fan control during thermo o in Heating mode can be changed by the remote controller.



(The procedure should be done only by service personnel.)

It is possible to select from 3 patterns.

PROCEDURE

Press  (POWERFUL) button,  (FAN SPEED) button and press  [RESET] button simultaneously.

Release  [RESET] button only and make sure that all marks on the remote controller display are indicated, then release

 (POWERFUL) button and  (FAN SPEED) button.

Remote controller now enters Intermittent Fan Control Change Mode

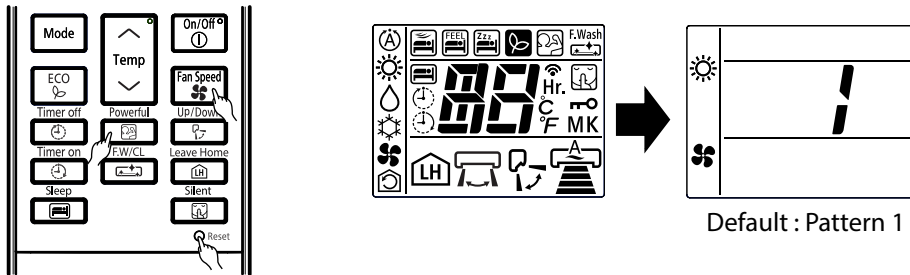

Press [ROOM TEMPERATURE setting] [ (UP) /  (DOWN)] button.

(The intermittent pattern changed with indoor unit beep sound)

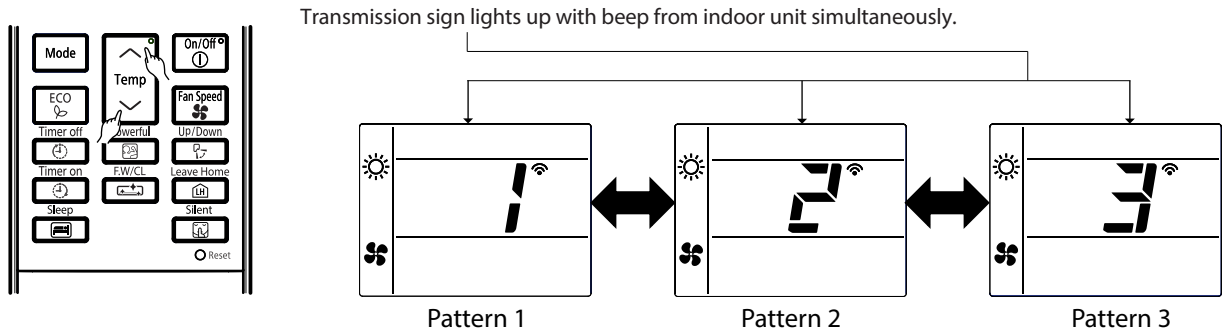

	Pattern 1	Pattern 2	Pattern 3
Single model	Continuous	30sec ON / 210sec OFF repeatedly	50sec ON / 190sec OFF repeatedly
Multi	30sec ON / 210sec OFF repeatedly	50sec ON / 190sec OFF repeatedly	Continuous









NOTE:

- (1) The indication of the selected intermittent pattern will disappear after 10 seconds.
- (2) The selected intermittent pattern will remain unchanged after the unit is truned o.



DISPLAY OPERATION MODE SETTING

For operating indoor unit independently (without outdoor unit connection), remote controller must be set according to below procedures before send the signal to the indoor unit. New communication format between indoor and outdoor is required to communicate with outdoor unit.

PROCEDURE

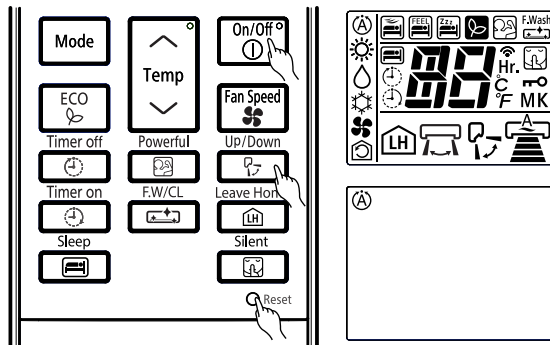
1. While pressing and holding  (ON/OFF) button and , press  (RESET) button on the same time. Release  (RESET) button only and make sure that all marks on the LCD display are indicated, then release the  (ON/OFF) button and  (UP/DOWN) button. Remote controller now enters "DISPLAY OPERATION MODE" for the indoor unit to run independently. Please ensure that when pressing  (FAN SPEED) button,  will be blinking.



2. Press the  (MODE) selector button to choose the desired operation mode.
3. Press  (ON/OFF) button.
Then, the indoor unit will start to operate independently according to the selected operation mode.

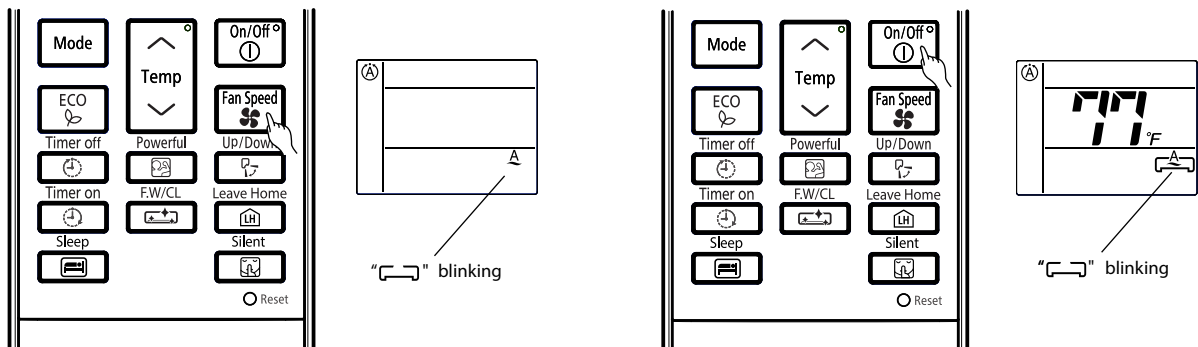

NOTE :

- (1) During "DISPLAY OPERATION MODE",  blinks on LCD of remote controller.
- (2) When operation stops, "DISPLAY OPERATION MODE" is canceled.

Diagnosis and troubleshooting of indoor electric parts, outdoor electric parts and refrigerating cycle

Initiating troubleshooting

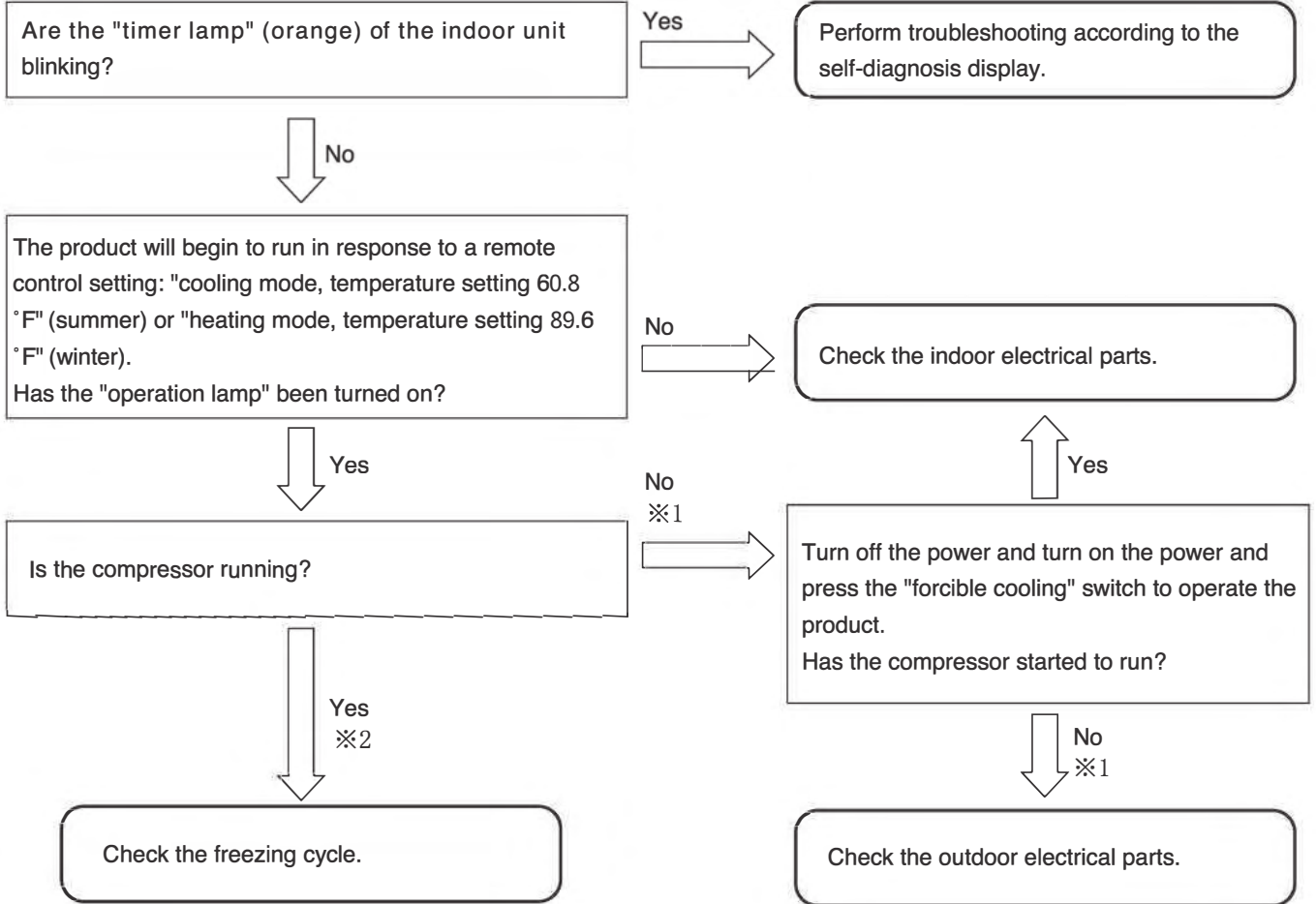

< Troubleshooting by using the self-diagnosis memory function >

- By using the self-diagnosis memory function, you can check the failure mode (※1) occurring in the outdoor electrical parts on the indoor unit side.

- Steps
1. Clear the troubleshooting data.
 2. Run the product for several minutes under the conditions where the compressor runs.
 3. Redisplay and check the data written in the self-diagnosis memory.

- The self-diagnosis memory function can also be used to catch failure phenomena.

- Steps
1. Clear the troubleshooting data.
 2. Have the user use the product as usual until a failure phenomenon occurs.
(The period depends on the incidence of the phenomenon.)
 3. At a later date, redisplay and check the data written in the self-diagnosis memory.

- For the outdoor self-diagnosis display (OH thermistor heat-up, overload lower limit cut) stemming from the freezing cycle or operating condition, the time lag is long from operation startup to the emergence of the phenomenon. Moreover, it is affected by the temperature, sunshine, operating hours, and other factors of the day, so that the phenomenon may not be able to be identified at the time of a repair service visit. In that case too, use the self-diagnosis memory function (※2).
- The outdoor self-diagnosis display "overload lower limit cut" and "OH thermistor heat-up" can be identified only when you are using the self-diagnosis lamp of the outdoor unit and the self-diagnosis memory function of the indoor unit. Note that this will not be automatically displayed on the indoor unit side.

Checking the indoor unit electrical parts

Introduction

First check the failure phenomenon and status, and then move on to elaborate diagnosis.

Initiating troubleshooting

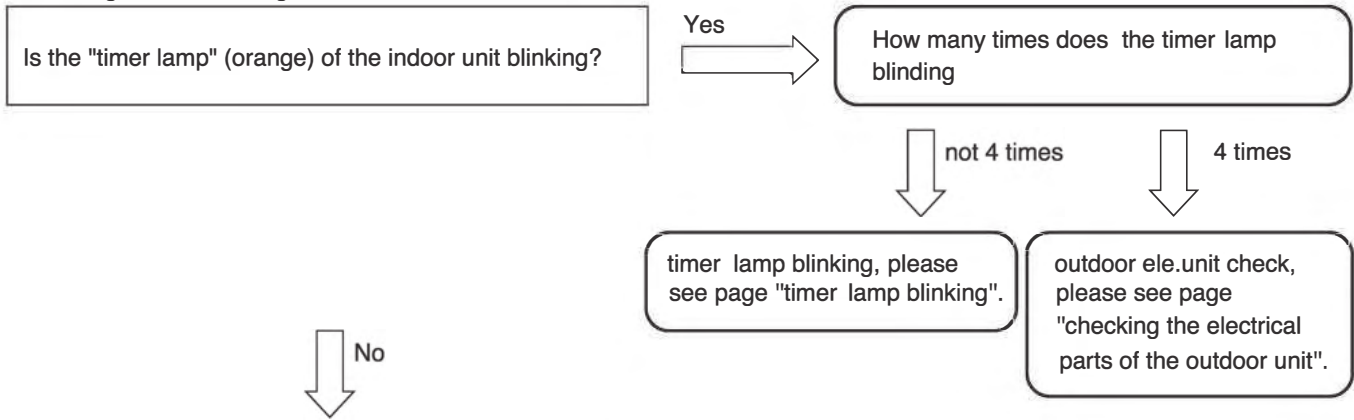

Turn off the power, wait at least 5 seconds, turn it back on, and observe the way the horizontal vanes move for about 30 seconds.

Check 1: Have the horizontal vanes moved? (Yes/No)



Set the remote control unit to cooling mode, temperature setting 16°C (summer), heating mode, temperature setting 32°C (winter) and operate the product.

Check 2: Has the product received the remote control signal and has the "operation lamp" gone on? (Yes/No)

If you responded "Yes" to Check 2:

Check 3: Is the compressor of the outdoor unit running? (Yes/No)

If you responded "No" to Check 2:

Check 4: Does the "emergency operation switch" work? (Yes/No)

Check results and next check items

Check 1	Check 2	Check 3	Check 4	Next check item
No	No	—	No	Go on to "The power will not become turned on".
Yes	No	—	Yes	Go on to "The product will not receive the remote control signal".
Yes	Yes	No	—	Go on to "The compressor will not run".

1. Failure phenomenon: The power will not become turned on.

[Situation] Neither initialization, remote control, nor any other step works on the vane position at power-on.

[Estimated failure locations]

- 3.15 A fuse blown out
- Control power circuit
- Connector loose, wire break

Estimated cause of fuse blowout	<ul style="list-style-type: none"> · Abnormally high voltage applied to the power supply · Indoor fan motor out of order · Power circuit out of order
---------------------------------	--

[Cautions]

- Before work, check the power supply voltage. An abnormal voltage may be being supplied in some rare occasions due to a defect in the indoor wiring (a wire break in the neutral wire of the single-phase 3-wire power supply).
- If the 3.15 A fuse has blown out, eliminate the cause of the fuse blowout. Otherwise, there will occur another fuse blowout.
- If the 3.15 A fuse has blown out due to an abnormally high voltage to the power supply, the varistor (VA001) will deteriorate and become destroyed as well.
- On a repair service visit due to the failure phenomenon of "The power will not become turned on", take a "3.15 A fuse" and a "varistor" with you.

[Diagnosis flow]

Initiating troubleshooting

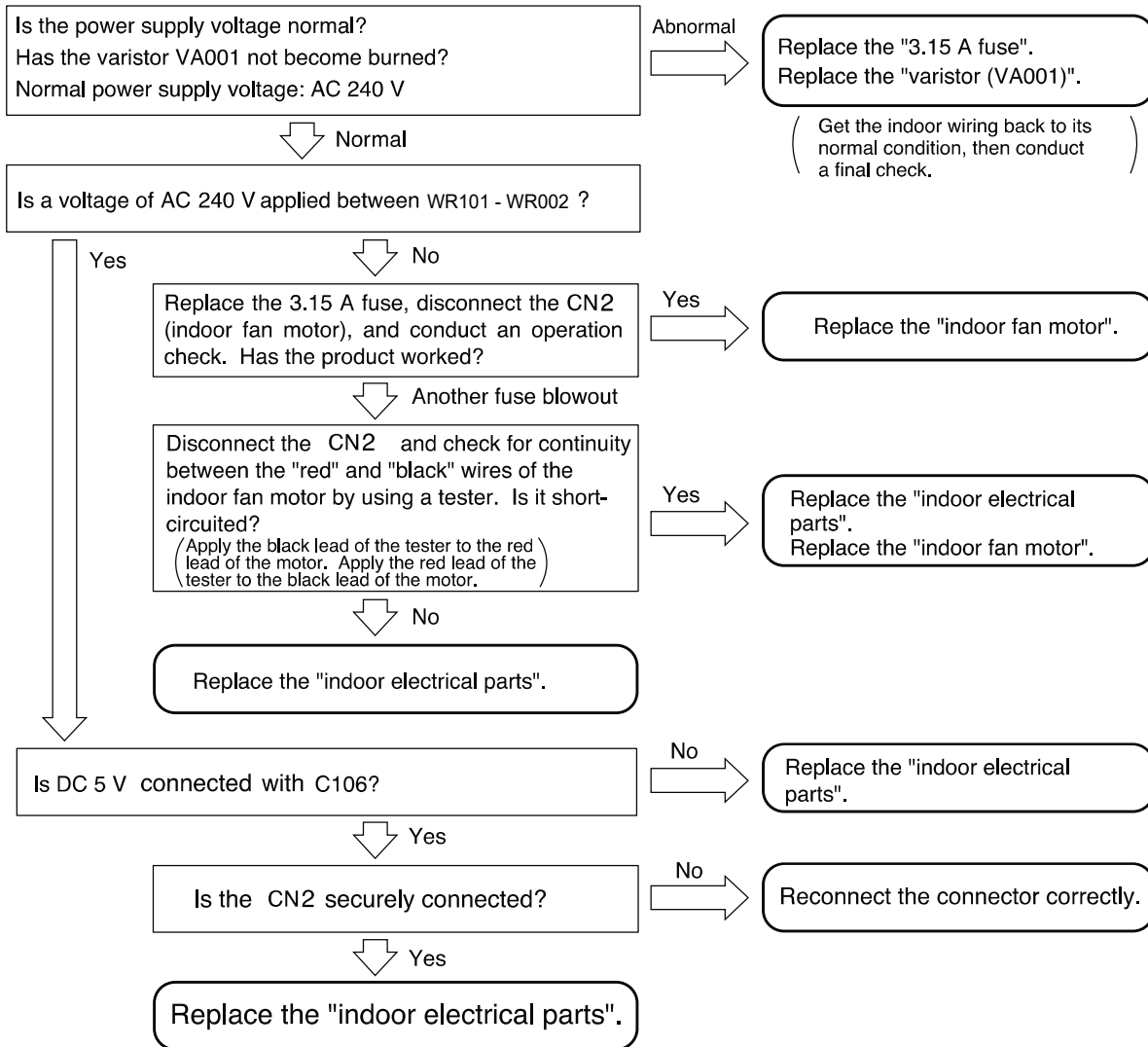

2.Failure phenomenon: The product will not receive a remote control signal.

- [Situation] The product does not receive a remote control signal. It is not very responsive.
(The product does run normally in response to the emergency operation switch.)
- [Estimated failure locations]
- Remote control failure, remote control low battery level, remote control poorly set
 - Remote control light-receiving unit
 - Connector loose, wire break
 - Normal product (external factors: the remote control units for lighting equipment and other equipment, electrical noise, etc.)
- [Cautions]
- Even if the product is trouble-free, a factor coming from outside the product may hamper the reception of signals from the remote control unit.
 - Batteries may decline in capacity at low temperatures. Old batteries decline particularly much in voltage in the morning and evening of winter, resulting in the poor arrival of remote control signals. Instruct your users to use new alkaline batteries.

[Diagnosis flow]

Initiating troubleshooting

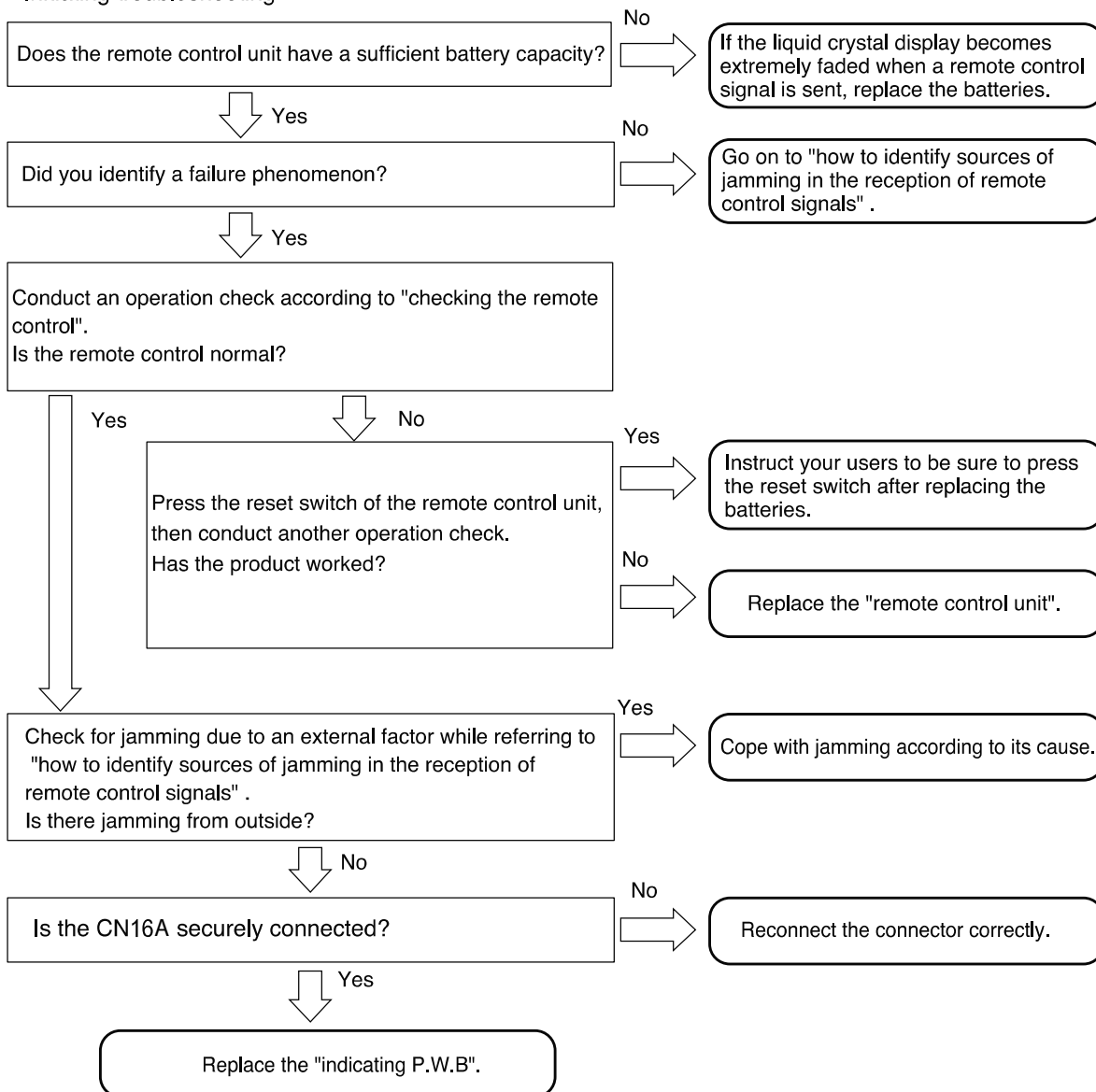

[Cautions in replacing the indicating P.W.B] Be sure to replace the indicating P.W.B. components.

How to identify sources of jamming in the reception of remote control signals

[Situation] The product may become poorly responsive to remote control signals due to external factors even though the product itself is trouble-free.

[Estimating sources of jamming] Identify the installation status of the air-conditioner and the indoor and outdoor environments to identify possible causes of the jamming.

- Indoor lighting equipment (quantity, type, location)
- Remote control units of other electrical products and equipment
- Is the grounding for the air-conditioner shared with other equipment?
- Are the surroundings of the air-conditioner clear of wireless antenna?
- Is the remote control light-receiving unit protected from direct sunlight?

[Checking and actions]

<p>Effects of lighting equipment (fluorescent lamps)</p>	<p><u>Checking points</u></p> <ul style="list-style-type: none"> · Turn on and off the lighting equipment and check for its effects on the reception of remote control signals. · When cold, the fluorescent lamp tends to emit infrared rays with wavelengths close to those used in remote control. <p>If you cannot detect the phenomenon about which your user is complaining at the time of your visit, such as "the product sometimes fails to receive remote control signals" and "the product fails to receive remote control signals in the morning alone", then turn off the lighting for about 20-30 minutes and wait for the fluorescent lamps to cool down before conducting another check.</p> <p>There are even cases where the product fails to receive remote control signals for 1 to 2 minutes only after the lighting equipment is turned on.</p> <ul style="list-style-type: none"> · The noise status may vary with the dimming of the lighting equipment. In the case of lighting equipment with a dimmer, therefore, conduct a check with all the light intensities. · If the lighting equipment is the source of the jamming, the remote control light-receiving unit output usually shows a noise waveform as shown in the right-hand figure. In the case of slight jamming, this kind of waveform will not cause practical problems. However, intense degrees of jamming will disable the reception of remote control signals. · When the fluorescent lamp is old and is flickering, it may cause disorders in the reception of remote control signals. <p><u>Actions proposed</u></p> <ol style="list-style-type: none"> 1. Make it hard for light of the lighting equipment to enter the remote control light-receiving unit. <ul style="list-style-type: none"> · Separate the lighting equipment from the indoor unit. · Raise the lighting equipment. · Cover the upper half of the light-receiving panel from its rear side with aluminum tape or black vinyl tape. <p>(This will also affect the reception of remote control signals. Therefore, set the range to be covered with tape to a range that is problem-free in practice, while checking the reception status.)</p> 2. Add an interference filter to the front panel of the remote control light-receiving unit. <ul style="list-style-type: none"> ※ Lighting equipment that produces strong jamming exists although rarely. Some problems may therefore be unsolvable by managing the air-conditioner side alone.
<p>Effects of the remote control units of other equipment</p>	<p><u>Checking points</u></p> <ul style="list-style-type: none"> · If, on the remote control unit of a TV or audio equipment, its sound volume key or something similar is left pressed, infrared signals become continuously sent, thereby jamming the reception of remote control signals. · Check how the remote control unit and related components are stored, thereby checking if there is any possibility that a button may be inadvertently left pressed on the remote control unit of other equipment. <p><u>Actions proposed</u></p> <p>If there is any such possibility, give explanations to your users to that effect and instruct them to exercise caution.</p>

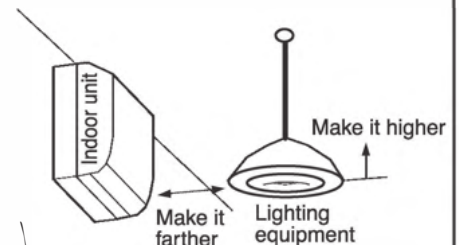
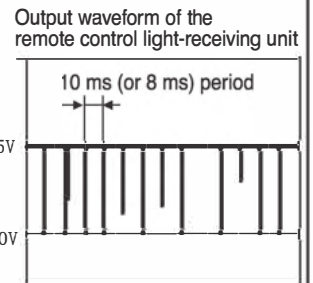

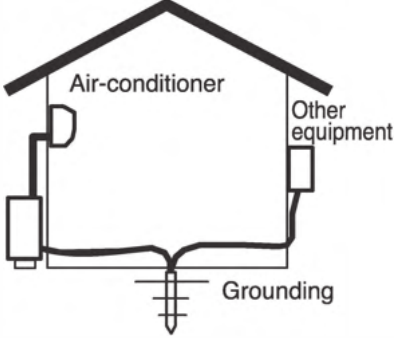
<p>Effects of other electrical products</p>	<p><u>Checking points</u></p> <ul style="list-style-type: none"> · Check the effects of light and power noises coming from other electrical products. · Turn on and off the electrical products, turn off the power and turn on the power, and check their effects on the reception of remote control signals. · For products whose operating states change, check the effects of each state. <p><u>Actions proposed</u></p> <ul style="list-style-type: none"> · Change the location relationship between the air-conditioner and the target products. · Use a different wall outlet for the target products.
<p>Sharing a grounding</p>	<p><u>Checking points</u></p> <ul style="list-style-type: none"> · Check for effects of electrical noises coming into the air-conditioner through grounding wires. · Check if the grounding works is for the air-conditioner alone or shared with other equipment. If there is any equipment that shares it, turn on and off that equipment and detach and reattach the power plugs and examine their effects on the reception of remote control signals. <p><u>Actions proposed</u></p> <ul style="list-style-type: none"> · Establish an independent grounding for the air-conditioner. 
<p>Effects of radio waves</p>	<p><u>Checking points</u></p> <ul style="list-style-type: none"> · Using a wireless transmitter near the air-conditioner may affect the reception of remote control signals. · Have your users try sending signals with a wireless transmitter and examine their effects on the reception of remote control signals. <p><u>Actions proposed</u></p> <ul style="list-style-type: none"> · Add a ferrite core to the power cord and F cable. · Add a ferrite core to the internal wiring of the indoor unit. · Move the wireless antenna.
<p>Effects of direct sunlight</p>	<p><u>Checking points</u></p> <ul style="list-style-type: none"> · Direct sunlight and other intense light make the remote control light-receiving unit less sensitive. · Check for any time zone where the remote control light-receiving unit of the indoor unit is affected by direct sunlight depending on the location of the sun and mirror reflection. <p><u>Actions proposed</u></p> <ul style="list-style-type: none"> · Block the sunlight to protect against direct sunlight.

3. Failure phenomenon: The compressor will not run.

[Situation] The compressor will not run (the same state as the thermometer turned off), the product receives remote control signals normally. The self-diagnosis lamp (LD301) of the outdoor unit blinks once or becomes turned off.

[Estimated failure locations] · Room temperature thermistor, heat exchanger thermistor
· Microcomputer peripheral circuit

[Diagnosis flow]
Initiating troubleshooting

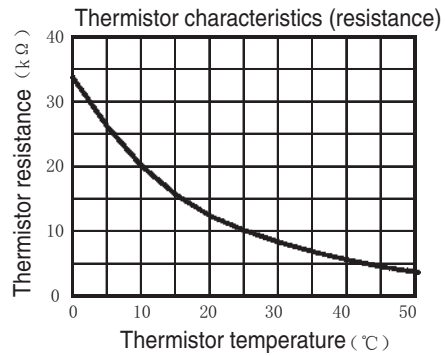
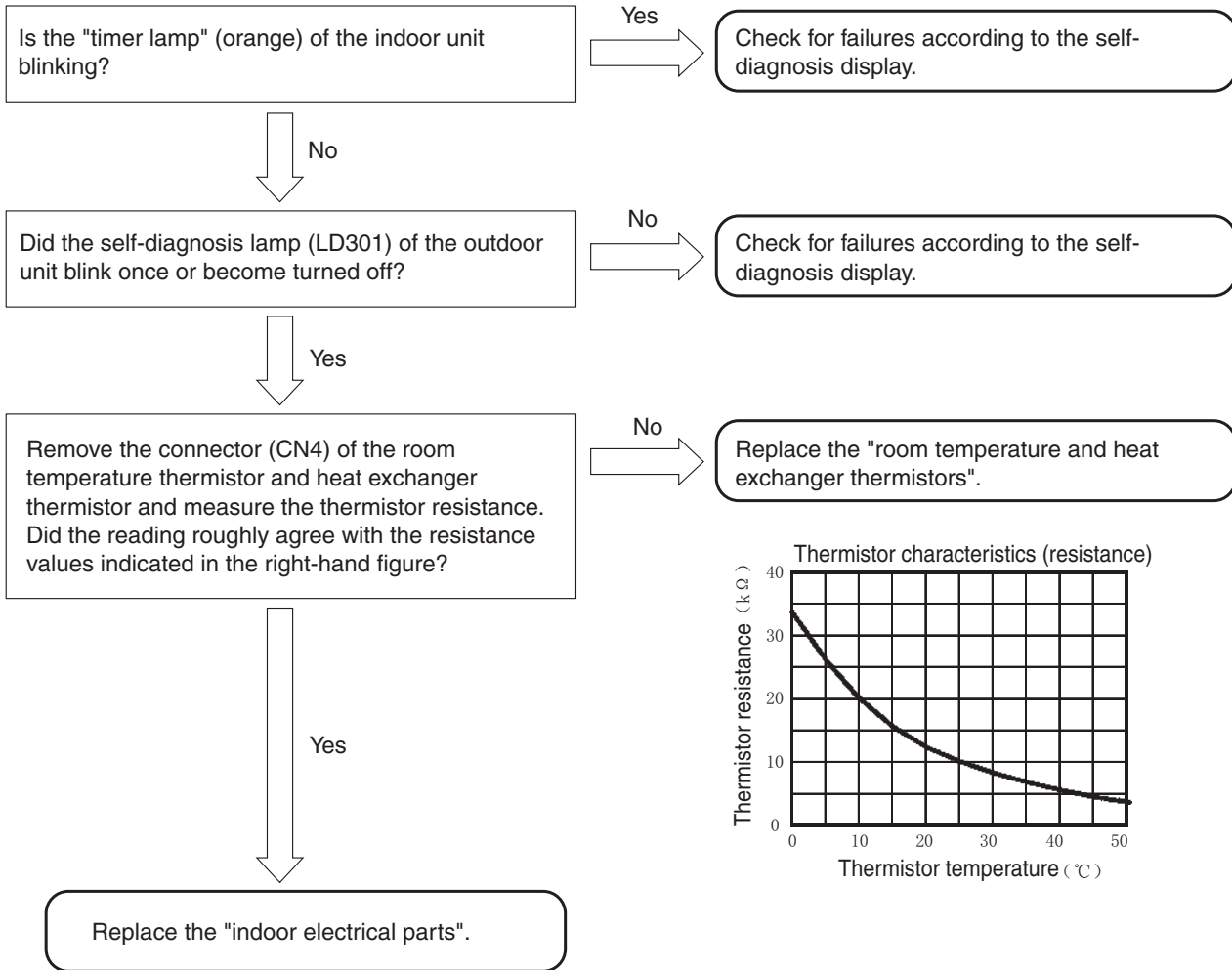

4. Failure phenomenon: The fan motor will not stop.

[Situation] I have conducted the stop operation on the product by remote control, but the indoor fan motor will not stop.
(It stopped about 10 minutes later.)

[Estimated failure locations]

- Indoor fan motor
- Fan motor drive circuit

[Diagnosis flow]

Initiating troubleshooting

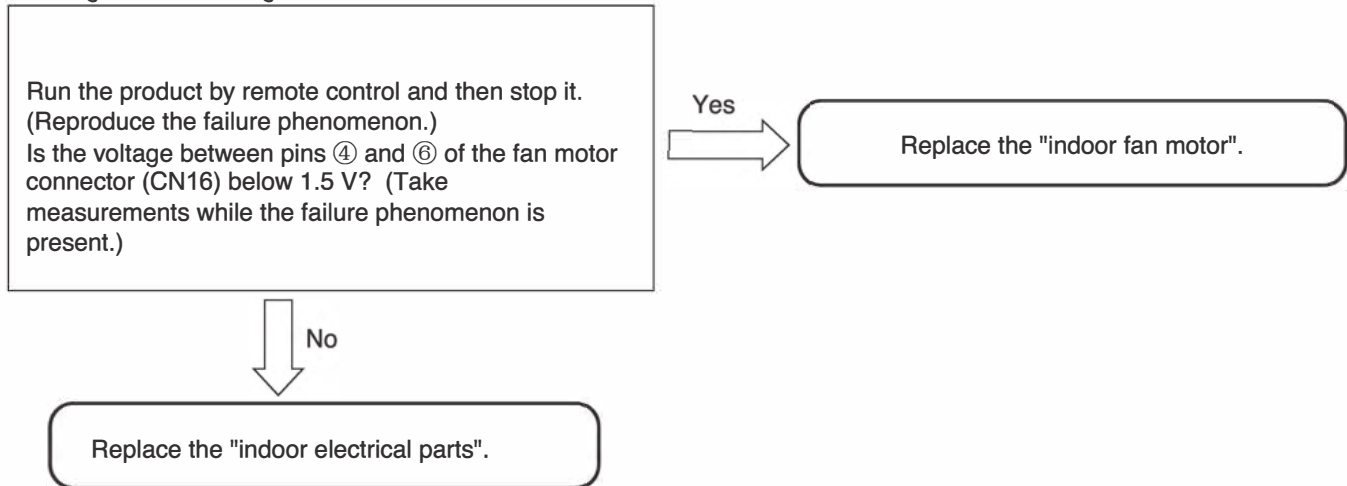

5. Timer lamp blinking: blinking once

[Situation] The timer lamp blinks one time and the product will not operate.
(This is not a sign of a breakdown.)

- [Estimated failure locations]
- Reversing valve defective.
 - The refrigerating cycle block gas leak.

6. Timer lamp blinking: blinking twice

[Situation] The product is giving a display to indicate that it is performing forcible cooling.
(This is not a sign of a breakdown.)

7. Timer lamp blinking: blinking three times

[Situation] The timer lamp blinks three times and the product will not operate.

- [Estimated failure locations]
- Meltdown of the terminal board temperature fuse (the terminal board poorly inserted into the connection cable)
 - Outdoor communication circuit out of order

- [Cautions]
- If a terminal board is replaced to counter the meltdown of the terminal board temperature fuse, ensure that the connection cable) to be inserted into the terminal board has the appropriate dimension for peeling the insulation sheathing and that the insertion region is unbent before inserting it into the terminal board securely.

[Diagnosis flow]
Initiating troubleshooting

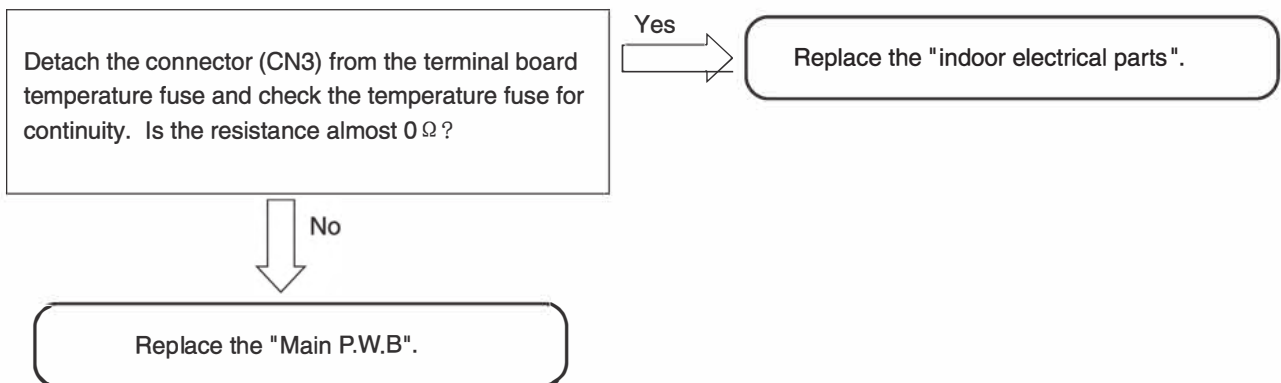

8. Timer lamp blinking: blinking four times

[Situation] The timer lamp blinks four times and the product will not operate.

- [Estimated failure locations]
- Outdoor unit error.
 - Please confirm the times of the LD301 blinking, and then see the outdoor selfcheck lable.

9. Timer lamp blinking: blinking 9 times

[Situation] The timer lamp blinks 9 times and the product will not run.

[Estimated failure location] • Loose connector, wire break, or short-circuit in the room temperature thermistor or heat exchanger thermistor.

[Cautions] • Starting the product by remote control will initiate failure detection.
(Merely turning on the power will not activate the failure detection function.)

[Diagnosis flow]
Initiating troubleshooting

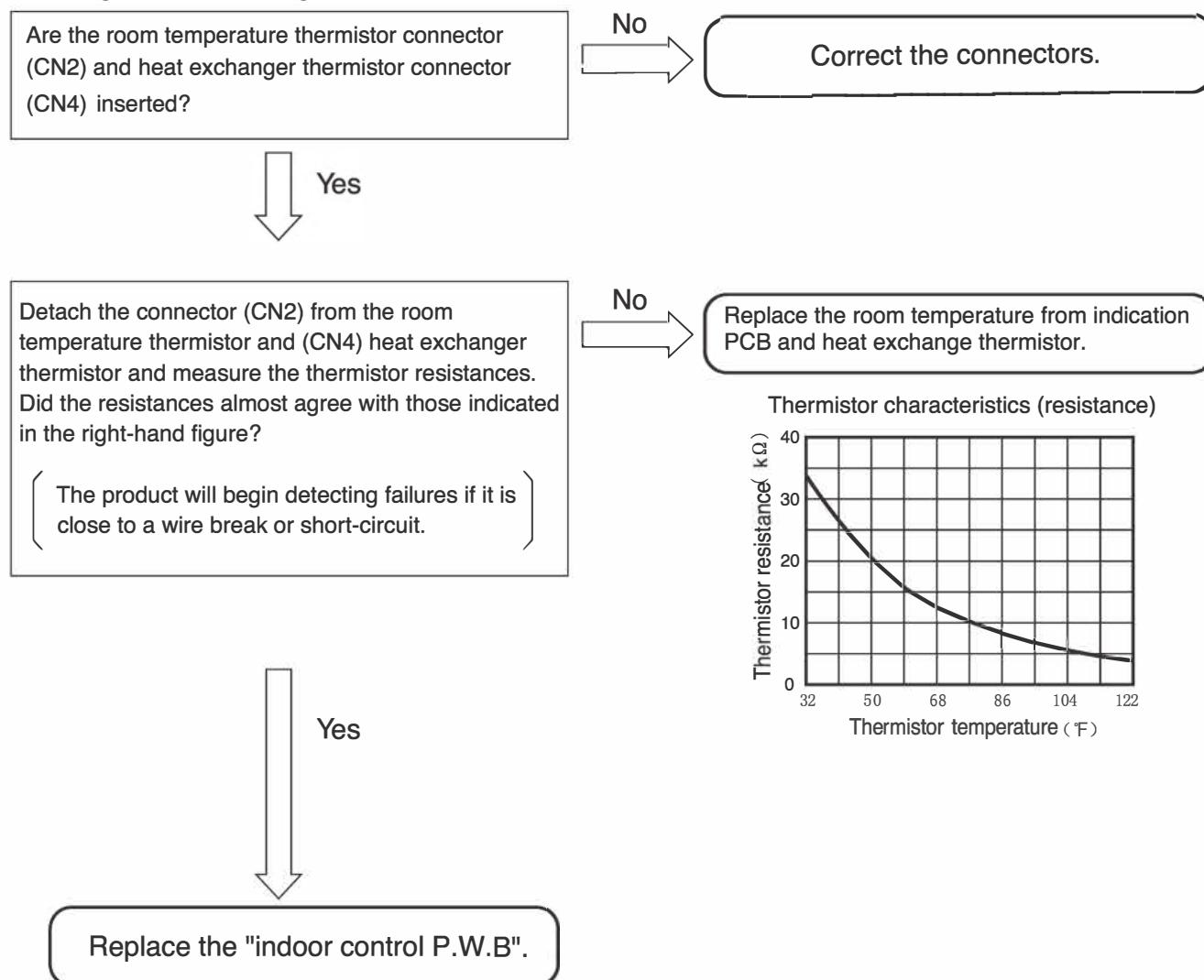

10. Timer lamp blinking: blinking 10 times

[Situation] The timer lamp blinks 10 times and the product will not run.

- [Estimated failure locations]
- Loose connector or wire break in the indoor fan motor
 - Indoor fan motor mechanically locked
 - Indoor fan motor
 - Indoor fan motor drive circuit

[Diagnosis flow]

Initiating troubleshooting

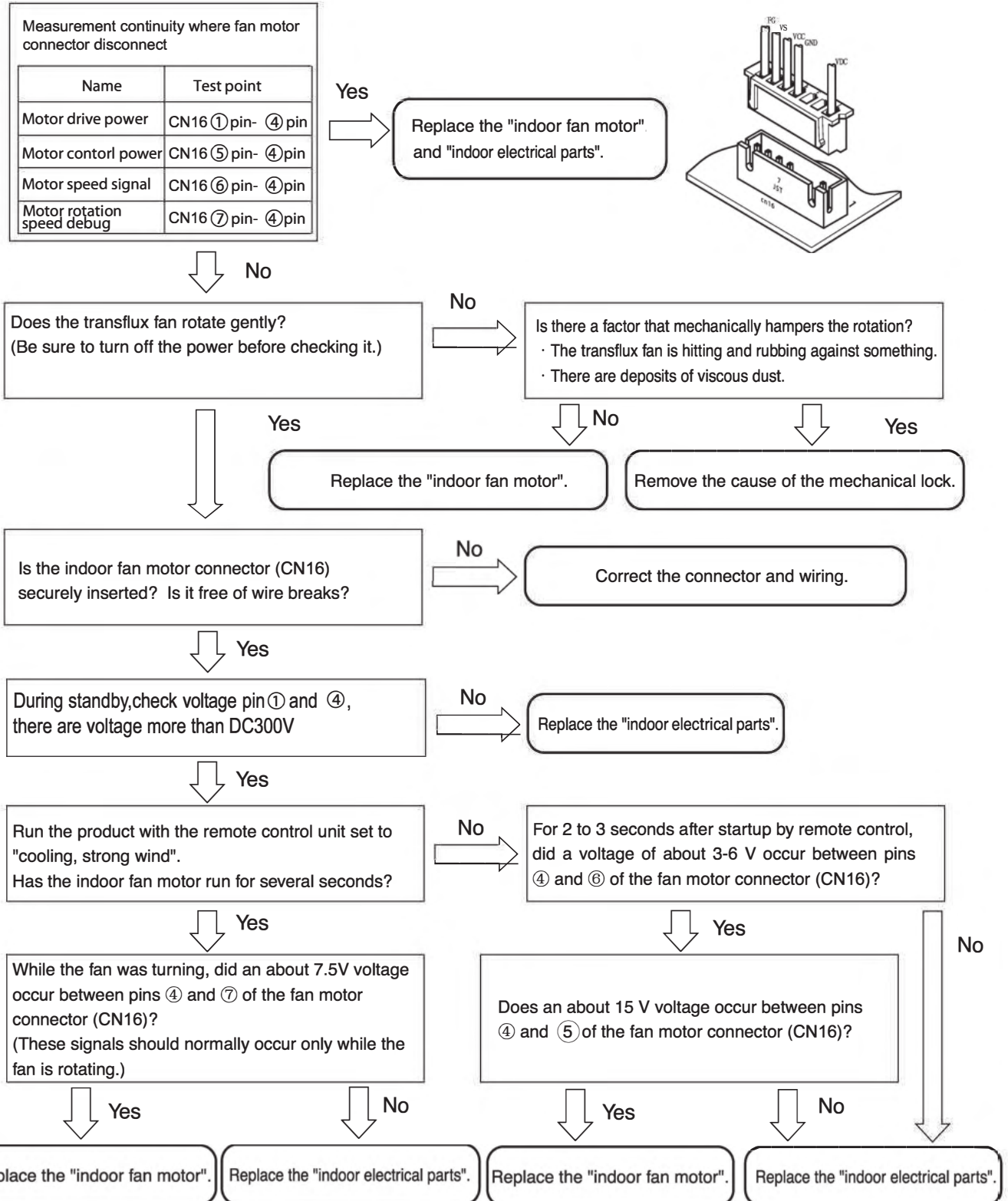

11. Timer lamp blinking : blinking 12 times

[Situation] The timer blinks 12 times and the product will not run.

- [Estimated failure locations]
- Erroneous connection in the indoor-outdoor connection line (connecting cable)
 - Forget to insert back self-check connector at CN27 of outdoor MAIN P.W.B
 - Wire break or poor insertion of the indoor-outdoor connection line (connecting cable)
 - Electrical parts in the outdoor unit (communication circuit, power circuit error)
 - Communication error due to noise in other home electronics
- ※This does not constitute a failure in the air-conditioner

[Cautions] • When lines 1 and 2 of connecting cable are erroneously connected (crossed), the product may not enter self-diagnosis display mode. If the self-diagnosis memory stores data about "timer lamp blinked 12 times", then, just in case, check if the connecting cable is not erroneously connected

[Diagnosis flow]

Initiating troubleshooting

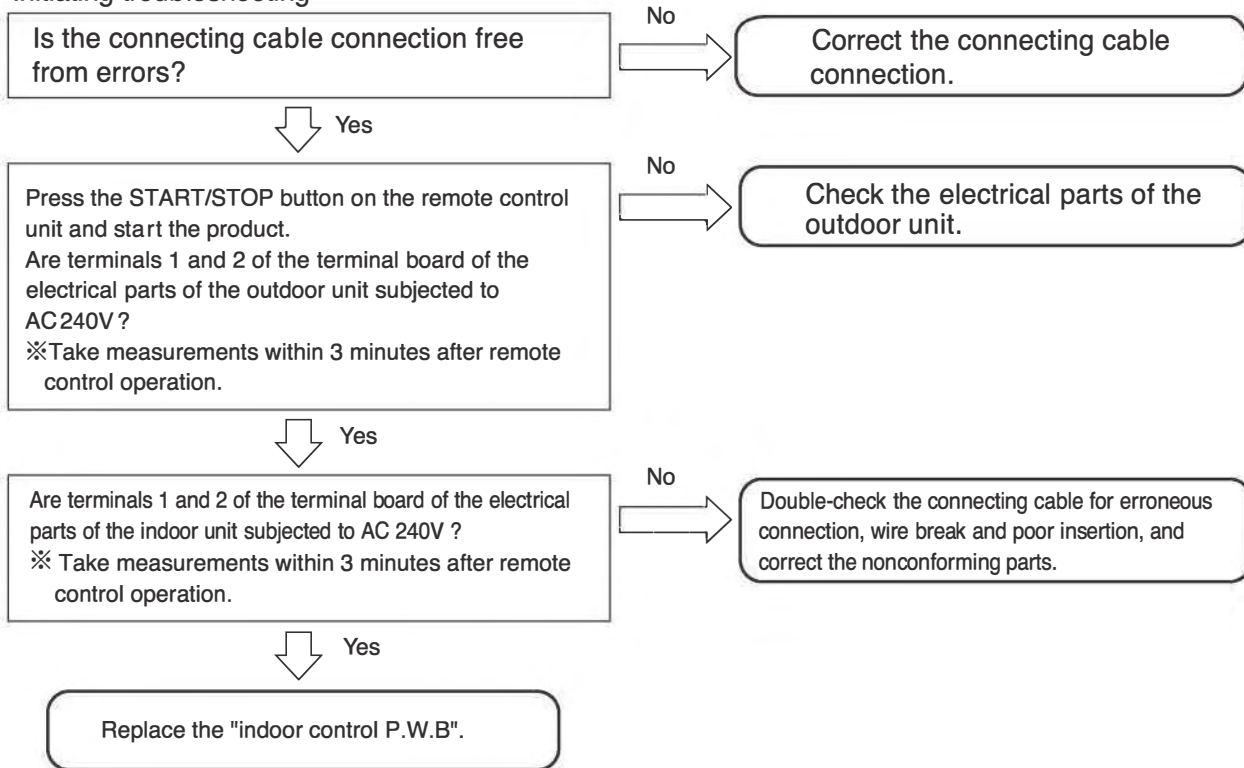

12. Timer lamp blinking : blinking 13 times

[Situation] The timer lamp blinks 13 times and the product will not run.

[Estimated failure location] • EEPROM, microcomputer

[Diagnosis flow]

Replace the "indoor control P.W.B".

Diagnosis and troubleshooting of outdoor electric parts and refrigerating cycle

Checking the electrical parts of the outdoor unit

After turning on the power, perform air purification by remote control.
 If there is not the air purifier and operating function, setting to 32°C by the remote control, and operate in the cooling mode.

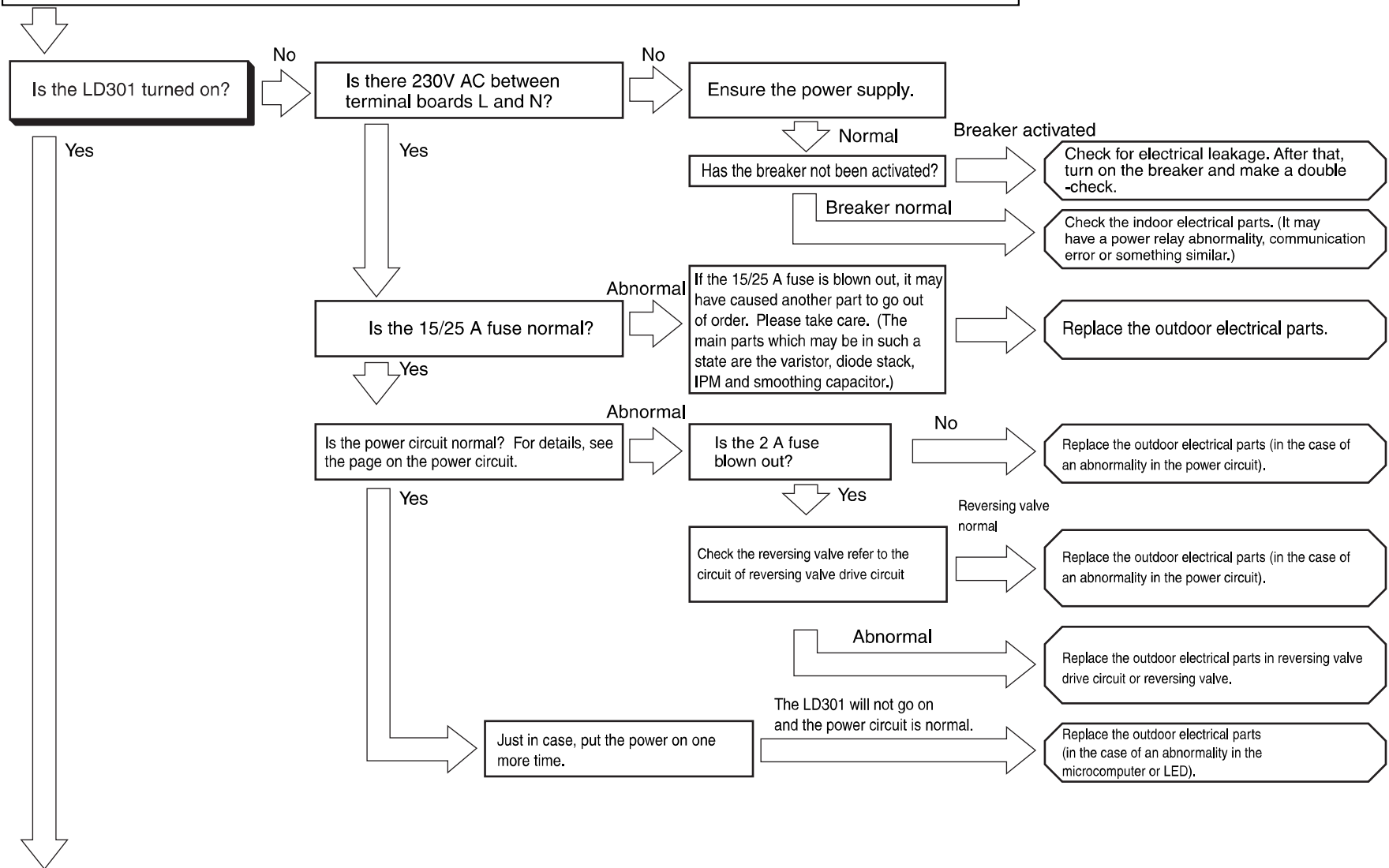

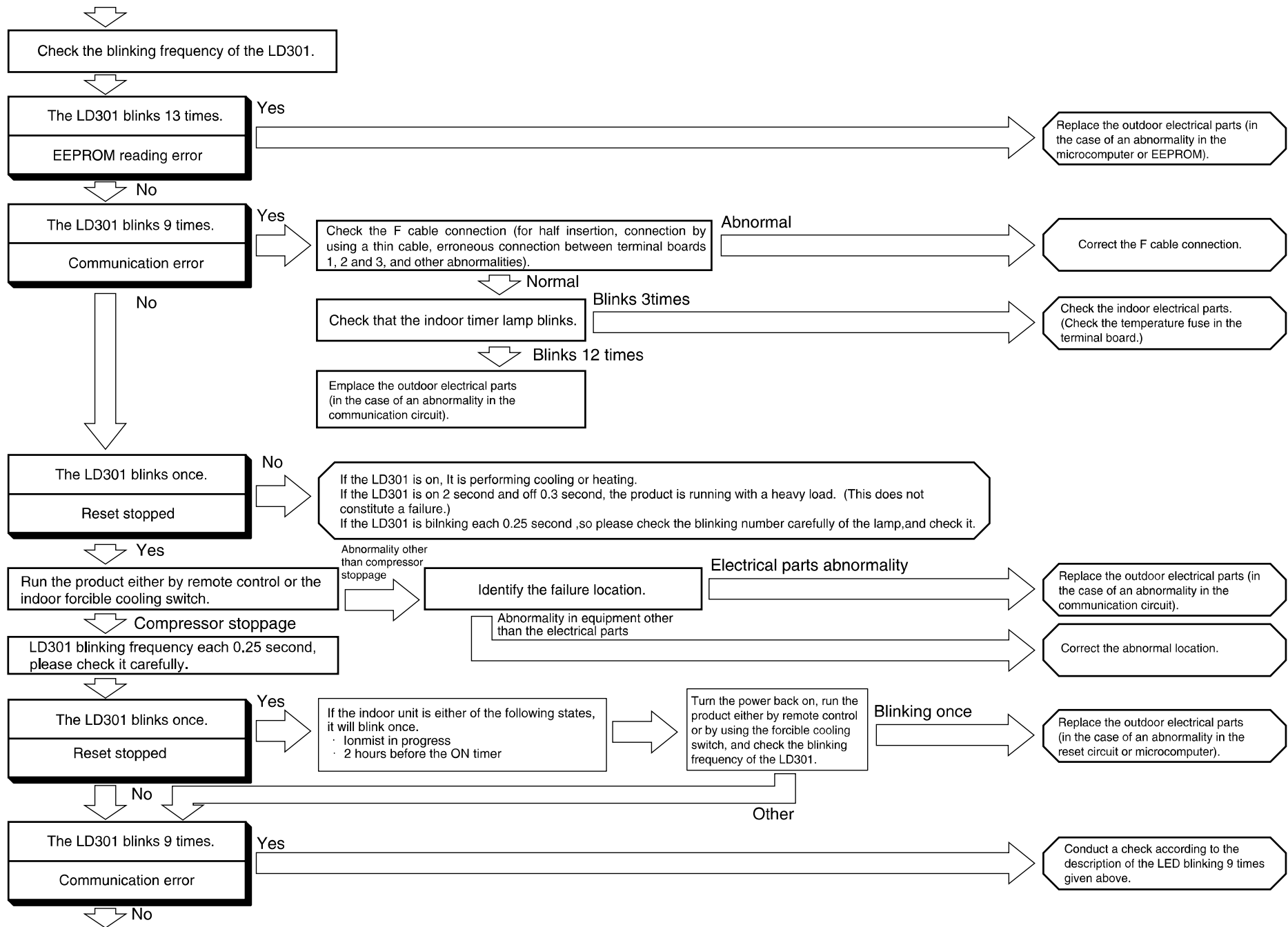

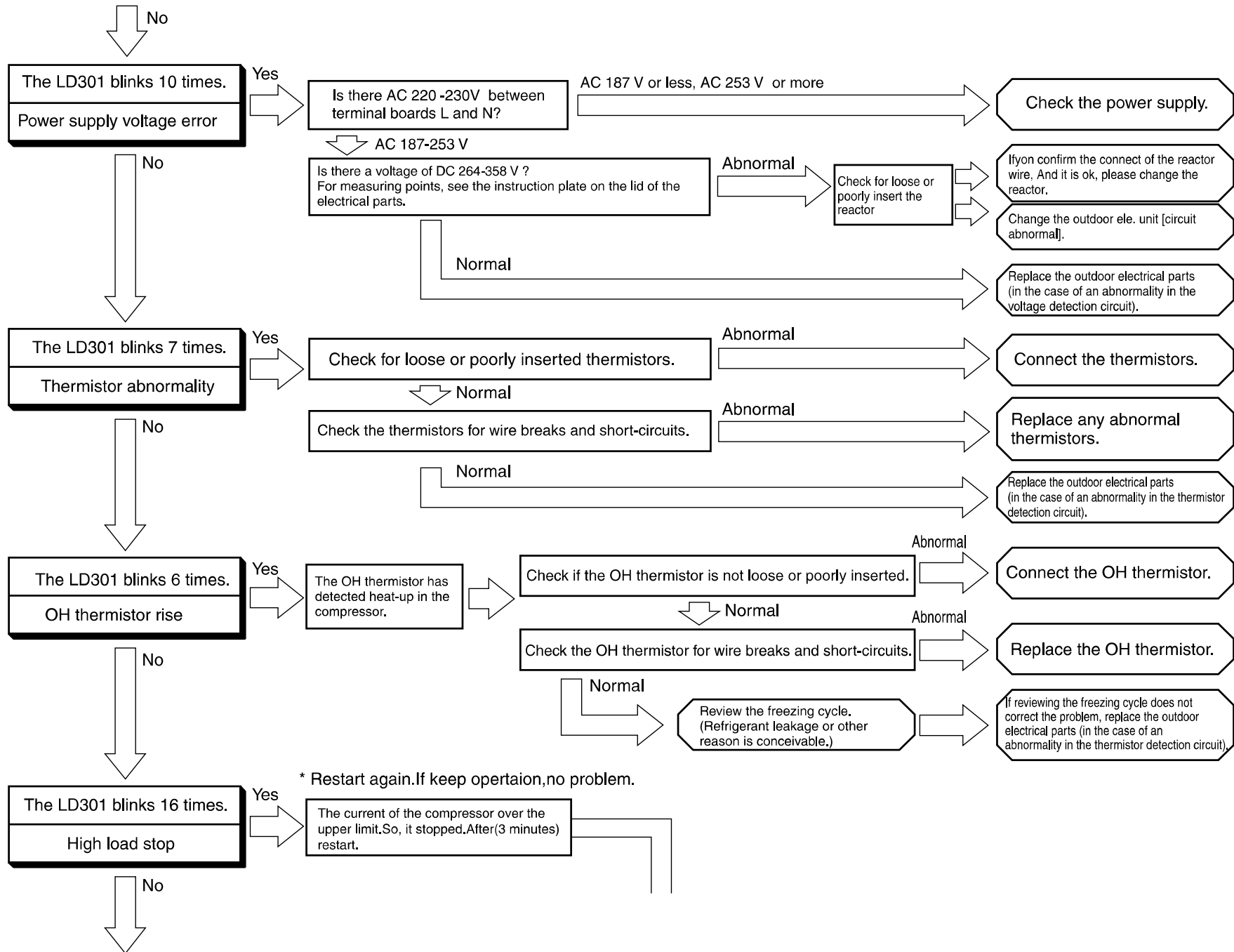

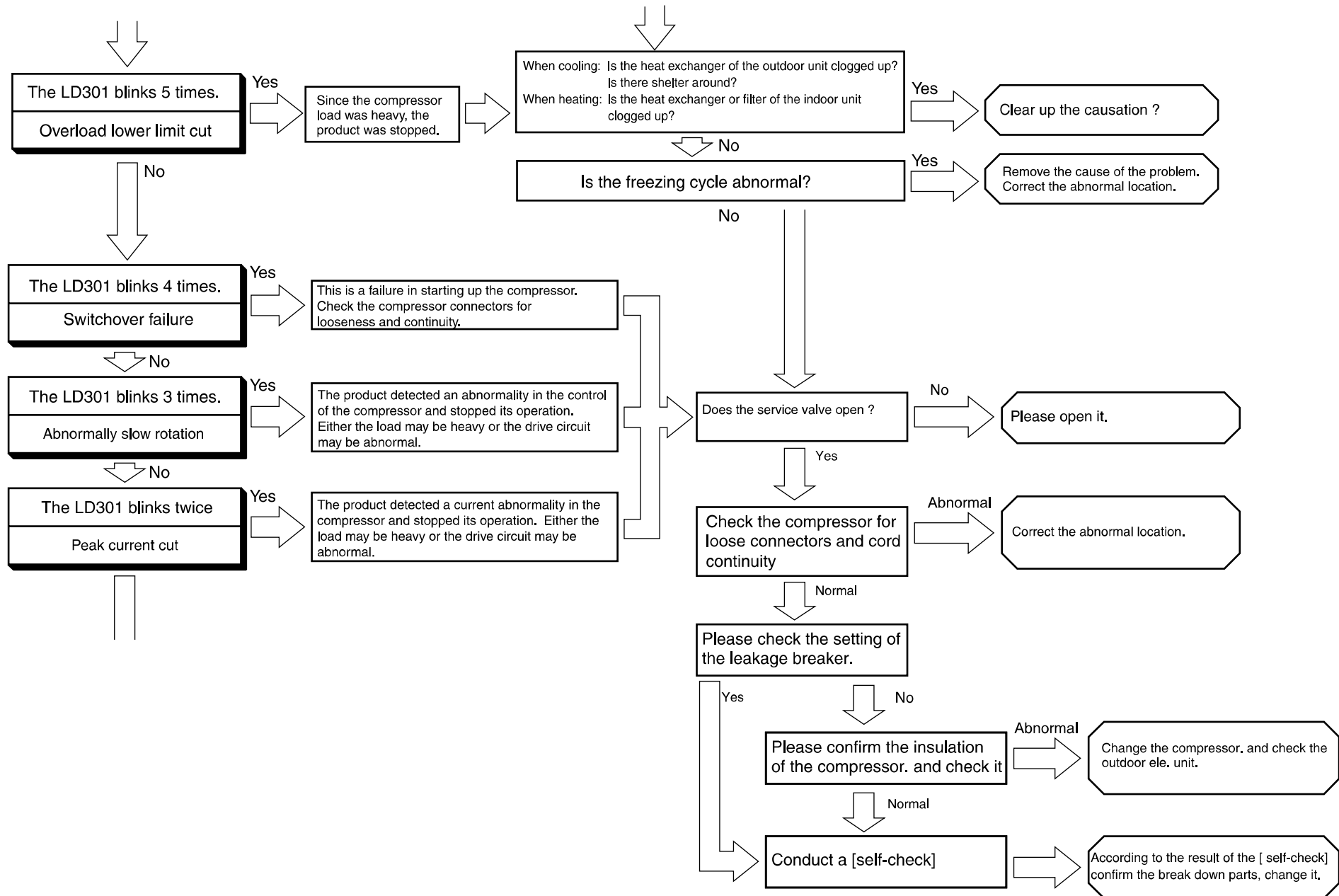

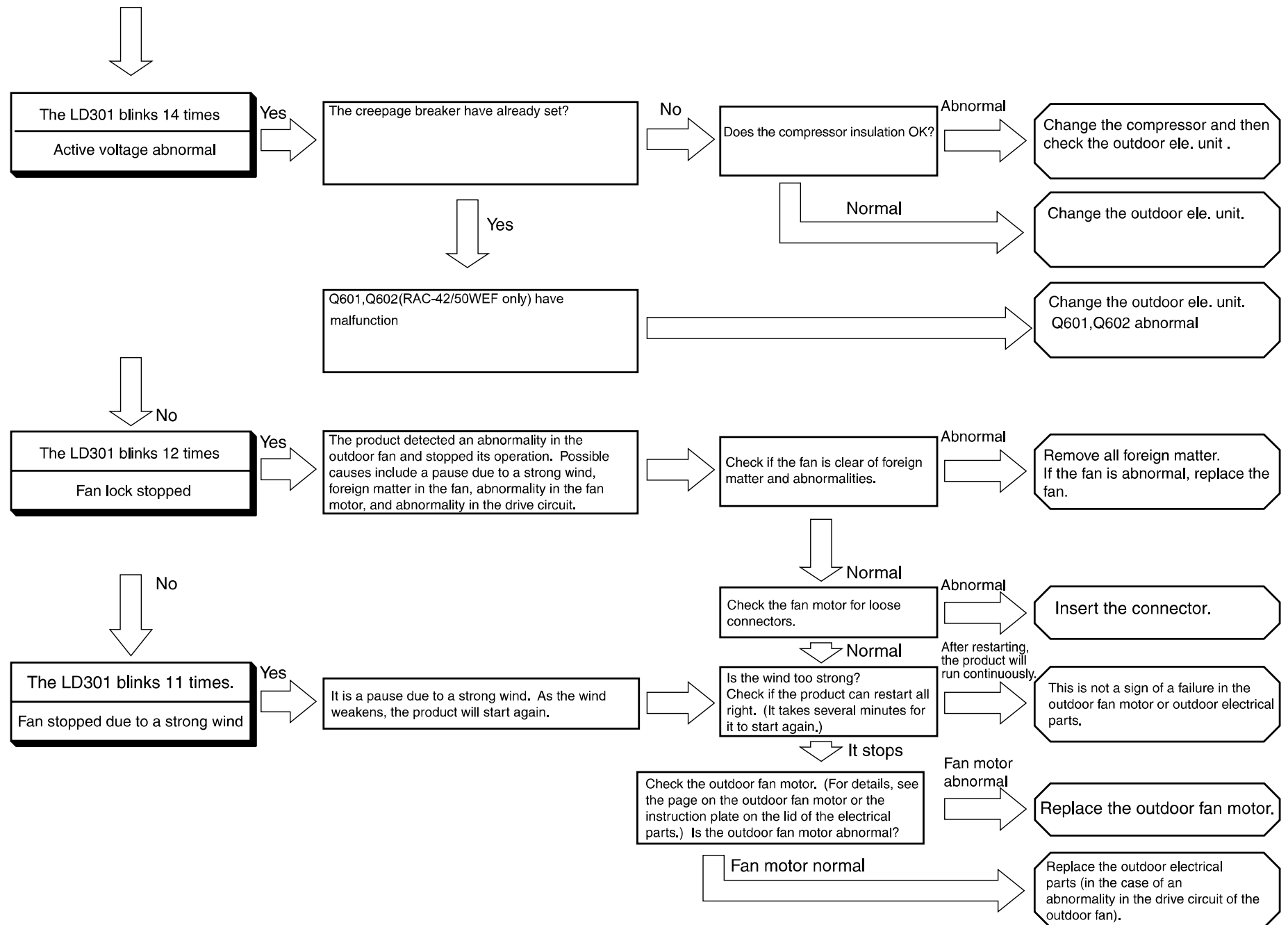

CHECKING THE REFRIGERATING CYCLE

(JUDGING BETWEEN GAS LEAKAGE AND COMPRESSOR DEFECTIVE)

1. Troubleshooting procedure (No operation, No heating, No cooling)

Connect U,V,W phase leads to the power module again and operate the air conditioner.



Is the self-diagnosis lamp mode as shown on the right?

Lighting mode Self-diagnosis lamp	Blinks 2 times	Blinks 3 times	Blinks 4 times	Blinks 5 times	Blinks 6 times	Blinks 8 times
	LD301					
Time until the lamp lights	Approx. 10 seconds			Approx. 10 seconds	Within Approx. 30 seconds	Approx. 10 seconds
Possible malfunctioning part	Compressor				Gas leakage	Compressor

Blinking off

Outdoor air temperature (°C)	Charge port pressure MPa(G) {kgf/cm ² (G)}
50	2.96 {30.14}
45	2.62 {26.72}
40	2.31 {23.58}
35	2.03 {20.73}
30	1.78 {18.14}
25	1.55 {15.79}
20	1.34 {13.66}
15	1.15 {11.74}
10	0.98 {10.02}
5	0.83 {8.48}
0	0.70 {7.10}
-5	0.58 {5.89}
-10	0.47 {4.81}

(R410A)

The values above are the theoretical ones.

YES

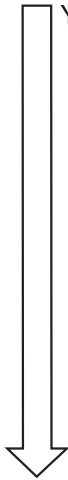

Stop to operate and check the gas pressure in balancing mode.

Normal

• Checking the IPM (main P.W.B.)

Error (Gas leaking)

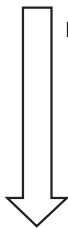

Gas leaks.
Repair and seal refrigerant.



When the self-diagnosis lamp lights in the same condition as above.

The compressor is defective. Replace it and seal refrigerant.
(If the compressor checker for an inverter type air conditioner is available, re-check using it.)

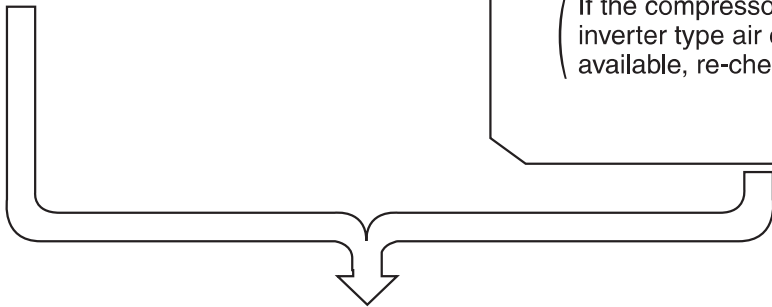

Perform a final check of operation.

How to run the product with the outdoor unit test switch

If the indoor electrical parts is out of order and if you wish to run the outdoor unit

1. Turn on the outdoor terminal boards L and N (220-230 V AC).
2. Confirm that the "LD301" blinks once from the terminal side of the outdoor unit. Afterwards (when about 30 sec elapses after the power turns on), confirm that the "LD301" changes to blinking 9 times (communication error).
3. When the "LD301" is blinks 9 times, if you press the test switch, the "LD301" lights up.

If you release your finger from the test switch within 1 sec to 4 sec after pressing the switch, the forced cooling operation starts.

※(If you press the test switch for 5 sec or longer, the self-check diagnosis starts. In this case, turn the power off and start the procedure from 1 again.)

※(For the initialization of the expansion valve, it may take 1 min until the operation starts.)

4. When you press the test switch again for 1 sec or longer, the unit stops the operation.

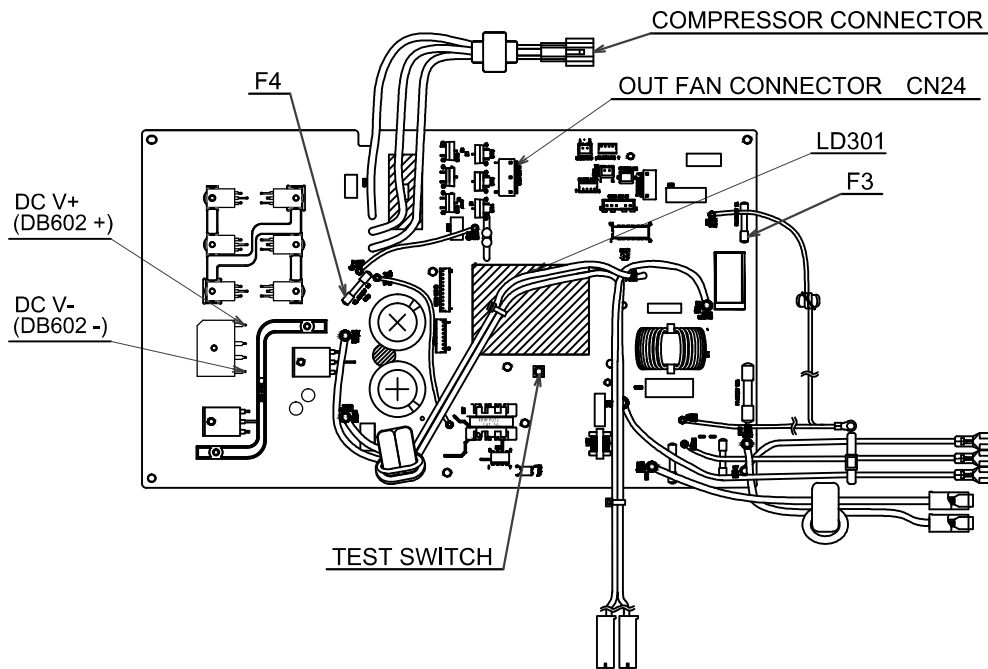

※Cautions

1. Applying power directly to the outdoor unit will cause a rush current to stress the outdoor unit. Therefore, if the indoor unit is not out of order, do not use the method described in 2).
2. Before making the connections, be sure to turn off the breaker.
3. Do not under any circumstances run the product for more than 5 minutes.
4. Doing work with the compressor connector removed will cause the LD301 to blink 4 times. It will not start.
5. For another test run, turn off the breaker and turn it back on. (The test switch is accepted only once after power-on. After operation by remote control, it is not accepted.)
6. When the operation with the test switch is over, turn off the breaker and set the connectors back.

HOW TO OPERATE THE OUTDOOR UNIT INDEPENDENTLY

RAC-PH18WHLAE

1. Connect the large dia. pipe side and small dia. pipe side service valve using a pipe.

Connect the small diameter service valve and the large diameter service valve using the reducing union and copper pipe as shown on the right.

Charge refrigerant of 300g after vacuuming (※1)

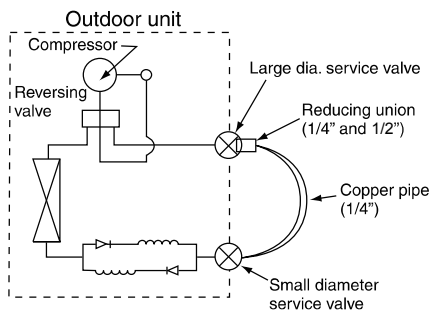

Parts to be prepared

- (1) Reducing union
1/4" (6.35 mm)
1/2" (12.7 mm)
- (2) Copper pipe (1/4" and 1/2")
- (3) Shorting leads
2 leads approx. 10 cm long with alligator clip or IC clip

Do not operate for more than 5 minutes

The operation method is the same as "How to operate using the connector to servicing the outdoor unit".

※1 The charging amount of 300g is equivalent to the load in normal operation.

RAC-PH24WHLAE

1. Connect the large dia. pipe side and small dia. pipe side service valves using a pipe.

Connect the small diameter service valve and the large diameter service valve using the reducing union and copper pipe as shown on the right.

Charge refrigerant of 300g after vacuuming (※1)

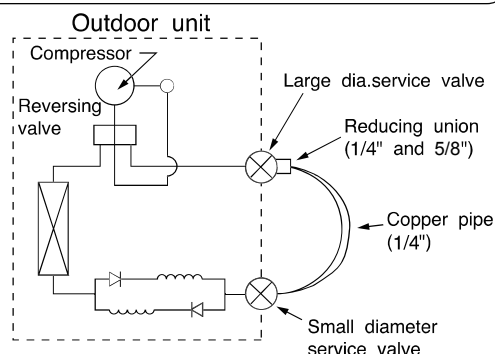

Parts to be prepared

- (1) Reducing union
1/4" (6.35 mm)
5/8" (15.88 mm)
- (2) Copper pipe (1/4" and 1/2")
- (3) Shorting leads
2 leads approx. 10 cm long with alligator clip or IC clip

Do not operate for 5 minutes or more.

The operation method is the same as "How to operate using the connector to servicing the outdoor unit".

※1 The charging amount of 300g is equivalent to the load in normal operation.

PARTS LIST AND DIAGRAM

INDOOR UNIT

MODEL RAS-PH18PHLAE
RAS-PH24PHLAE

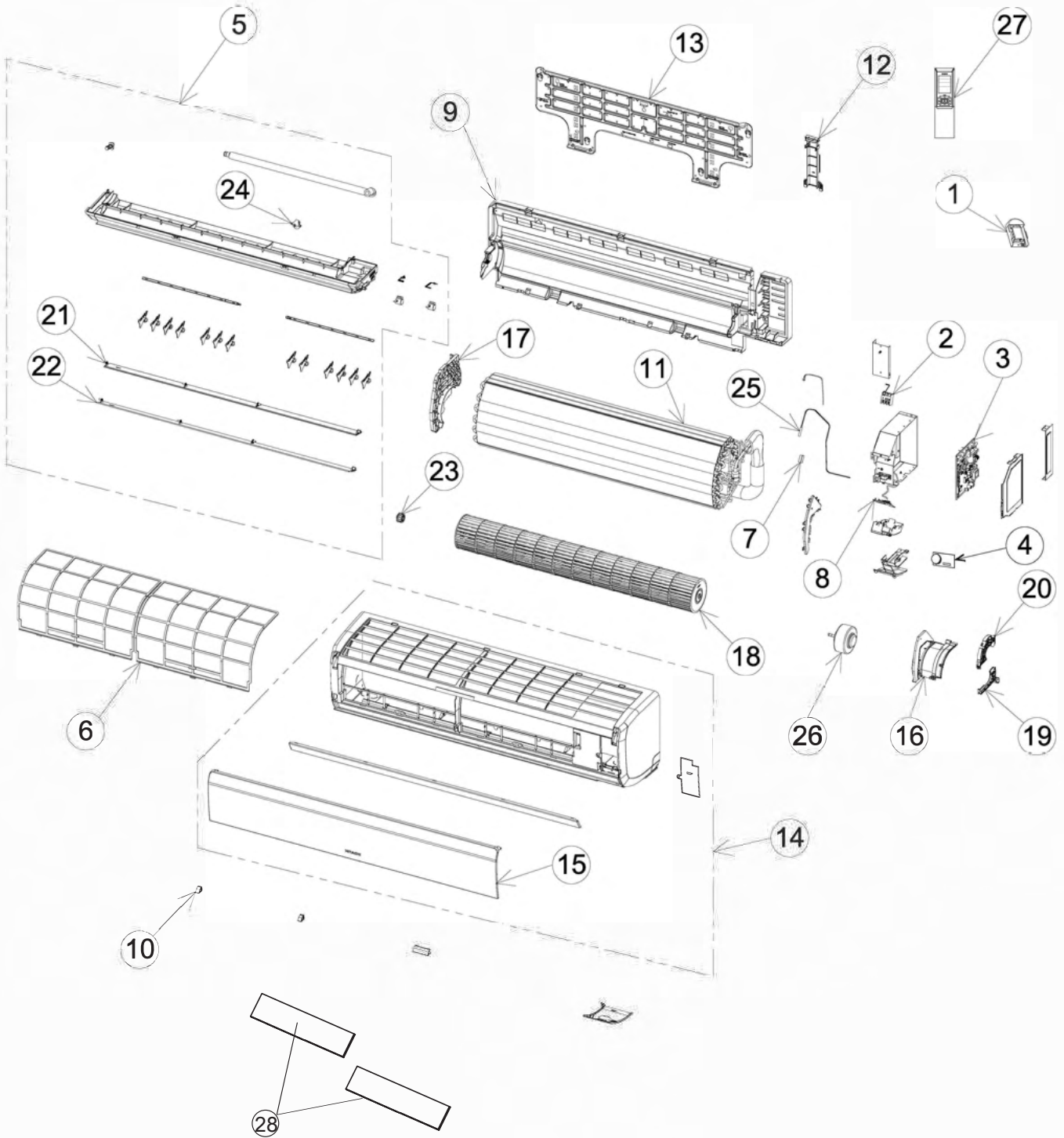

MODEL RAS-PH18PHLAE

NO.	PART NO.	Q'TY / UNIT	PARTS NAME
1	PMRAK-50PPA R07	1	REMOTE CONTROL SUPPORT
2	PMRAK-50PPD R07	1	TERMINAL BOARD (3P)
3	PMS-PH18PHLAE R01	1	P.W.B (MAIN)
4	PMRAS-S50YHAB R03	1	PWB (MS)
5	PMS-SH18RHLAE R02	1	DRAIN PAN ASSY
6	PMS-SH18RHLAE R03	2	FILTER
7	PMRAS-10C8M R03	1	THERMISTOR SUPPORT
8	PMRAS-S50YHAB R02	1	PWB RECEIVER
9	PMRAS-70YHA4 R04	1	CABINET
10	PMRAS-70YHA4 R05	1	CAP
11	PMRAS-50YHA R02	1	CYCLE ASSY
12	PMRAS-70YHA4 R08	1	PIPE SUPPORT
13	PMRAS-70YHA4 R09	1	MOUNTING PLATE
14	PMRAS-70YHA4 R10	1	FRONT COVER ASSY
15	PMRAS-70YHA4 R11	1	FRONT PANEL
16	PMRAS-70YHA4 R12	1	FAN MOTOR BASE
17	PMRAS-70YHA4 R13	1	BEARING COVER
18	PMRAS-X30HGT R02	1	TANGENTIAL FLOW FAN
19	PMRAS-70YHA4 R15	1	FAN MOTOR SUPP-RS
20	PMRAS-70YHA4 R16	1	FAN MOTOR SUPP-RU
21	PMRAS-70YHA4 R17	1	H-DEFLECT 1
22	PMRAS-70YHA4 R18	1	H-DEFLECT 2
23	PMRAS-25YH4 PM 908	1	P-BEARING ASSY
24	RAS-72CHA3 R01	1	AUTO SWEEP MOTOR
26	PMRAS-XH10CKT R06	1	THERMISTOR
26	PMS-EH24RHLAE R04	1	FAN MOTOR
27	PMS-SH09RHLAE R05	1	REMOTE CONTROLLER
28	SPX-CFH22AC25	2	ACL-FILTER

MODEL RAS-PH24PHLAE

NO.	PART NO.	Q'TY / UNIT	PARTS NAME
1	PMRAK-50PPA R07	1	REMOTE CONTROL SUPPORT
2	PMRAK-50PPD R07	1	TERMINAL BOARD (3P)
3	PMS-PH24PHLAE R01	1	P.W.B (MAIN)
4	PMRAS-S50YHAB R03	1	PWB (MS)
5	PMS-SH18RHLAE R02	1	DRAIN PAN ASSY
6	PMS-SH18RHLAE R03	2	FILTER
7	PMRAS-10C8M R03	1	THERMISTOR SUPPORT
8	PMRAS-S50YHAB R02	1	PWB RECEIVER
9	PMRAS-70YHA4 R04	1	CABINET
10	PMRAS-70YHA4 R05	1	CAP
11	PMRAS-50YHA R02	1	CYCLE ASSY
12	PMRAS-70YHA4 R08	1	PIPE SUPPORT
13	PMRAS-70YHA4 R09	1	MOUNTING PLATE
14	PMRAS-70YHA4 R10	1	FRONT COVER ASSY
15	PMRAS-70YHA4 R11	1	FRONT PANEL
16	PMRAS-70YHA4 R12	1	FAN MOTOR BASE
17	PMRAS-70YHA4 R13	1	BEARING COVER
18	PMRAS-X30HGT R02	1	TANGENTIAL FLOW FAN
19	PMRAS-70YHA4 R15	1	FAN MOTOR SUPP-RS
20	PMRAS-70YHA4 R16	1	FAN MOTOR SUPP-RU
21	PMRAS-70YHA4 R17	1	H-DEFLECT 1
22	PMRAS-70YHA4 R18	1	H-DEFLECT 2
23	PMRAS-25YH4 PM 908	1	P-BEARING ASSY
24	RAS-72CHA3 R01	1	AUTO SWEEP MOTOR
26	PMRAS-XH10CKT R06	1	THERMISTOR
26	PMS-EH24RHLAE R04	1	FAN MOTOR
27	PMS-SH09RHLAE R05	1	REMOTE CONTROLLER
28	SPX-CFH22AC25	2	ACL-FILTER

PARTS LIST AND DIAGRAM

OUTDOOR UNIT

MODEL RAC-PH18WHLAE
RAC-PH24WHLAE

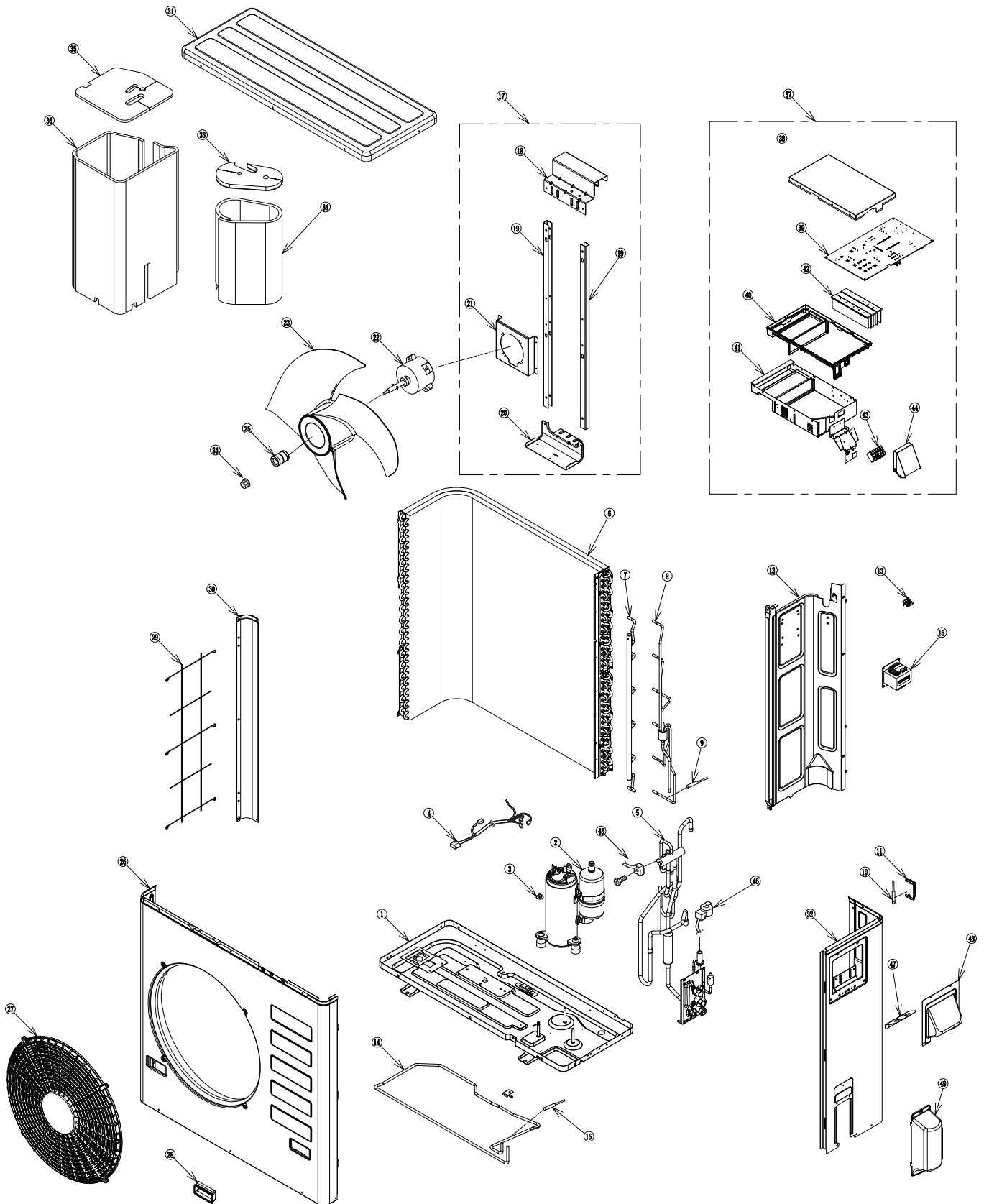

MODEL RAC-PH18WHLAE

No.	JCH-WH PARTS NO.	Q'TY/UNIT	PARTS NAME
1	HWRAC-PH18WHLAE A01	1	BASE AS
2	HWRAC-PH18WHLAE A02	1	COMPRESSOR
3	HWRAM-110NP5E A04	3	COMPRESSOR NUT
4	HWRAC-EH36WHLAE A02	1	CONNECT CORD (COMP)
5	HWRAC-PH18WHLAE A03	1	4-REVERSING VALVE AS
6	HWRAC-PH18WHLAE A04	1	CONDENSER
7	HWRAC-PH18WHLAE A05	1	EI-PIPE-AS
8	HWRAC-PH18WHLAE A06	1	EO-PIPE-AS
9	HWRAC-EH36WHLAE A09	1	TERMI-C
10	HWRAC-EH36WHLAE A10	1	TERMI-DEFROST
11	HWRAC-50WXDN A06	1	TERMI-COVER
12	HWRAC-PH18WHLAE A25	1	BULK
13	HWRAC-25WXDN A12	1	B-THERMO
14	HWRAC-PH18WHLAE A07	1	SHEATHED HEATER
15	HWRAC-PH18WHLAE A08	1	ONDO-FUSE
16	HWRAC-F160MVX 005	1	REACTOR
17	HWRAC-F160MVX 041	1	BRACKET GP-MOTOR
18	HWRAC-PH18WHLAE A09	1	FAN MOTOR SUPPORT
19	HWRAC-F160MVX 019	2	FAN MOTOR SUPPORT
20	HWRAC-F160MVX 020	1	FAN MOTOR SUPPORT
21	HWRAC-F86KVX 013	1	FAN MOTOR SUPPORT PLATE
22	HWRAC-F86KVX 018	1	FAN MOTOR
23	HWRAC-F86KVX 006	1	PROPELLER FAN
24	HWRAC-PH18WHLAE A10	1	FAN NUT
25	HWRAC-PH18WHLAE A11	1	NUT WASHER
26	HWRAC-EH36WHLAE A12	1	FRONT COVER
27	HWRAM-110NP5E A36	1	DISCHARGE GRILL
28	HWRAC-X10CSK 103	2	HANDER
29	HWRAC-L72GVX 004	1	NET LEFT
30	HWRAC-F160MVX 022	1	LEFT PLATE
31	HWRAC-PH18WHLAE A12	1	TOP COVER
32	HWRAC-PH18WHLAE A13	1	RIGHT COVER
33	HWRAC-PH18WHLAE A14	2	SOUND PROOF
34	HWRAC-PH18WHLAE A15	1	SOUND PROOF
35	HWRAC-PH18WHLAE A16	1	SOUND PROOF
36	HWRAC-PH18WHLAE A17	1	SOUND PROOF
37	HWRAC-PH18WHLAE A18	1	ELECTRICAL BOX
38	HWRAC-PH18WHLAE A19	1	ELECTRICAL PARTS COVER
39	HWRAC-PH18WHLAE A20	1	P.W.B (MAIN)
40	HWRAC-PH18WHLAE A21	1	SUPPORT (P.W.B)
41	HWRAC-PH18WHLAE A22	1	EXECTRICAL PLATE ASS
42	HWRAC-PH18WHLAE A23	1	HEAT SINK
43	HWRAC-50WED A16	1	TERMINAL BOARD (5P)
44	HWRAC-PH18WHLAE A24	1	TERMINAL COVER
45	HWRAC-EH36WHLAE A21	1	4 VALVE COIL
46	HWRAC-EH36WHLAE A22	1	EXV COIL
47	HWRAC-EH36WHLAE A23	1	CONDUIT PLATE
48	HWRAC-EH36WHLAE A24	1	TERMINAL COVER
49	HWRAC-F160MVX	1	SIDE COVER

MODEL RAC-PH24WHLAE

No.	JCH-WH PARTS NO.	Q'TY/UNIT	PARTS NAME
1	HWRAC-PH18WHLAE A01	1	BASE AS
2	HWRAC-PH18WHLAE A02	1	COMPRESSOR
3	HWRAM-110NP5E A04	3	COMPRESSOR NUT
4	HWRAC-EH36WHLAE A02	1	CONNECT CORD (COMP)
5	HWRAC-PH24WHLAE A01	1	4-REVERSING VALVE AS
6	HWRAC-PH18WHLAE A04	1	CONDENSER
7	HWRAC-PH18WHLAE A05	1	EI-PIPE-AS
8	HWRAC-PH18WHLAE A06	1	EO-PIPE-AS
9	HWRAC-EH36WHLAE A09	1	TERMI-C
10	HWRAC-EH36WHLAE A10	1	TERMI-DEFROST
11	HWRAC-50WDXN A06	1	TERMI-COVER
12	HWRAC-PH18WHLAE A25	1	BULK
13	HWRAC-25WDXN A12	1	B-THERMO
14	HWRAC-PH18WHLAE A07	1	SHEATHED HEATER
15	HWRAC-PH18WHLAE A08	1	ONDO-FUSE
16	HWRAC-F160MVX 005	1	REACTOR
17	HWRAC-F160MVX 041	1	BRACKET GP-MOTOR
18	HWRAC-PH18WHLAE A09	1	FAN MOTOR SUPPORT
19	HWRAC-F160MVX 019	2	FAN MOTOR SUPPORT
20	HWRAC-F160MVX 020	1	FAN MOTOR SUPPORT
21	HWRAC-F86KVX 013	1	FAN MOTOR SUPPORT PLATE
22	HWRAC-F86KVX 018	1	FAN MOTOR
23	HWRAC-F86KVX 006	1	PROPELLER FAN
24	HWRAC-PH18WHLAE A10	1	FAN NUT
25	HWRAC-PH18WHLAE A11	1	NUT WASHER
26	HWRAC-EH36WHLAE A12	1	FRONT COVER
27	HWRAM-110NP5E A36	1	DISCHARGE GRILL
28	HWRAC-X10CSK 103	2	HANDER
29	HWRAC-L72GVX 004	1	NET LEFT
30	HWRAC-F160MVX 022	1	LEFT PLATE
31	HWRAC-PH18WHLAE A12	1	TOP COVER
32	HWRAC-PH18WHLAE A13	1	RIGHT COVER
33	HWRAC-PH18WHLAE A14	2	SOUND PROOF
34	HWRAC-PH18WHLAE A15	1	SOUND PROOF
35	HWRAC-PH18WHLAE A16	1	SOUND PROOF
36	HWRAC-PH18WHLAE A17	1	SOUND PROOF
37	HWRAC-PH24WHLAE A02	1	ELECTRICAL BOX
38	HWRAC-PH18WHLAE A19	1	ELECTRICAL PARTS COVER
39	HWRAC-PH24WHLAE A03	1	P.W.B (MAIN)
40	HWRAC-PH18WHLAE A21	1	SUPPORT (P.W.B)
41	HWRAC-PH18WHLAE A22	1	EXECTRICAL PLATE ASS
42	HWRAC-PH18WHLAE A23	1	HEAT SINK
43	HWRAC-50WED A16	1	TERMINAL BOARD (5P)
44	HWRAC-PH18WHLAE A24	1	TERMINAL COVER
45	HWRAC-EH36WHLAE A21	1	4 VALVE COIL
46	HWRAC-EH36WHLAE A22	1	EXV COIL
47	HWRAC-EH36WHLAE A23	1	CONDUIT PLATE
48	HWRAC-EH36WHLAE A24	1	TERMINAL COVER
49	HWRAC-F160MVX	1	SIDE COVER

HITACHI

RAS-PH18PHLAE / RAC-PH18WHLAE
RAS-PH24PHLAE / RAC-PH24WHLAE

PM NO. 0764E

Printed in Malaysia